

Proportions - similar figures - integers

Pairs are similar. Try to find a pair:

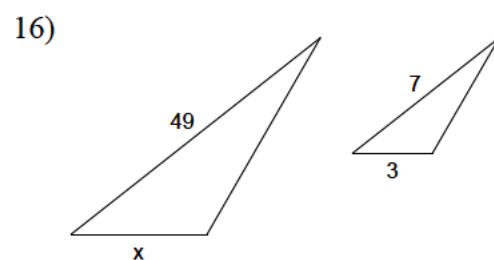

17)

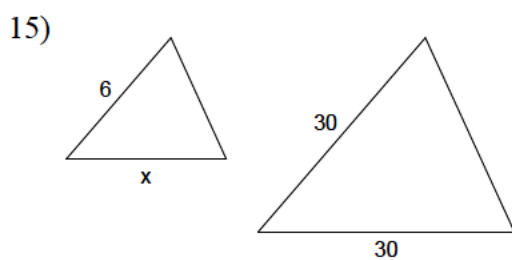
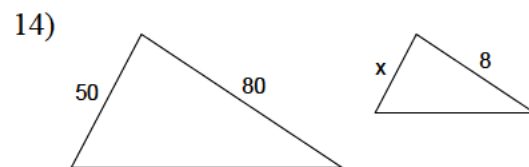
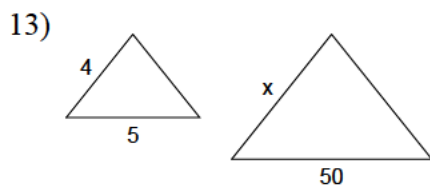
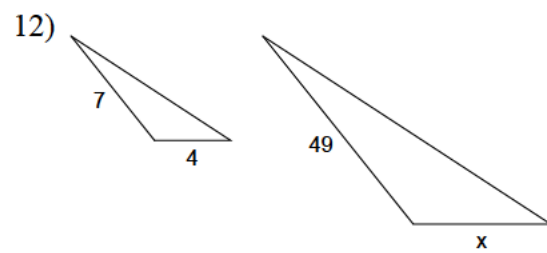
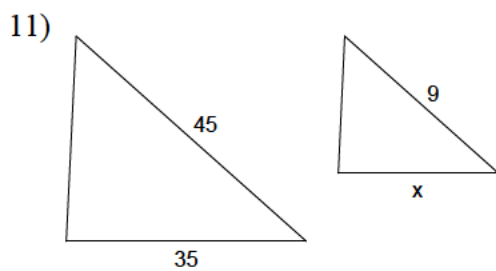
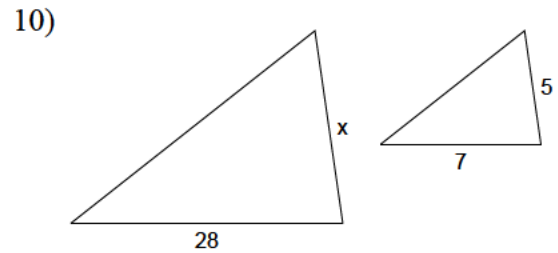
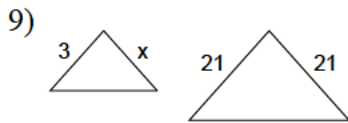
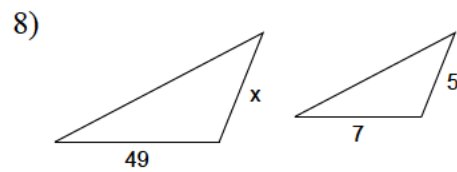
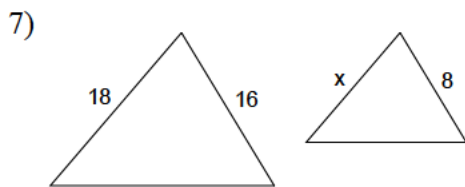
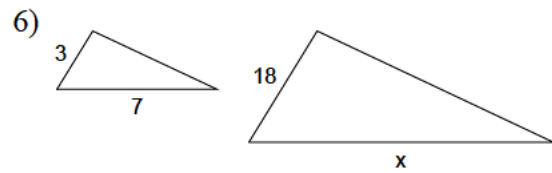
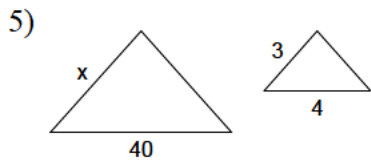
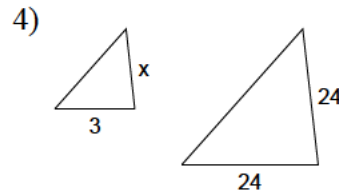
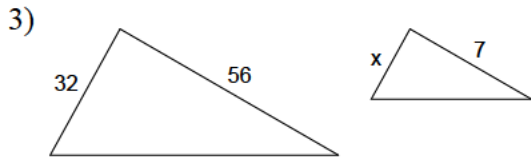
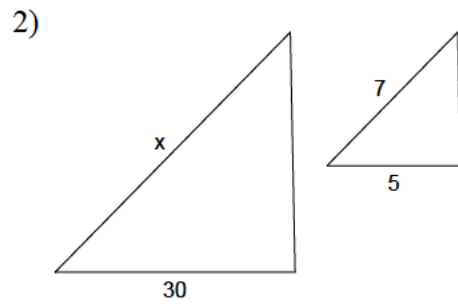
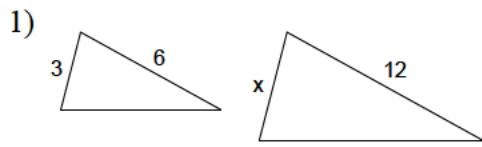
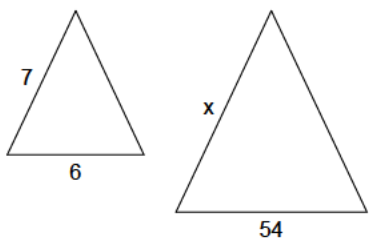

18)

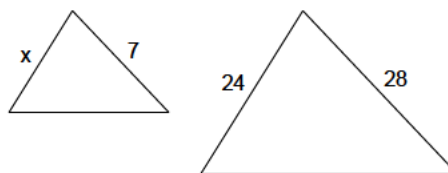

19)

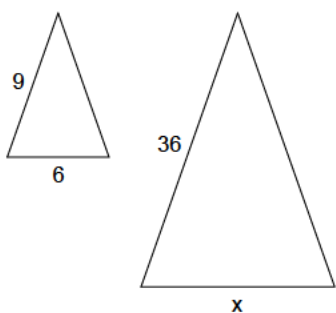

20)

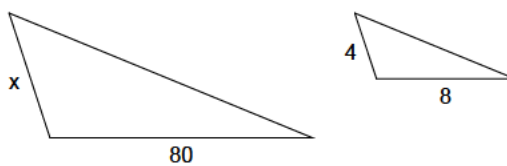

21)

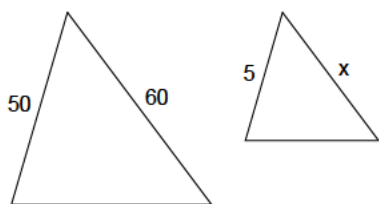

22)

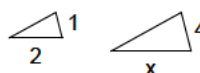

23)

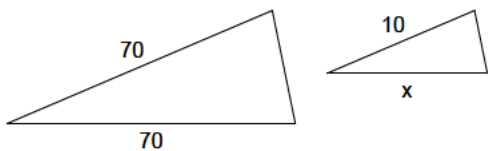

24)

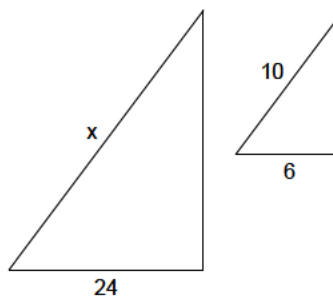

25)

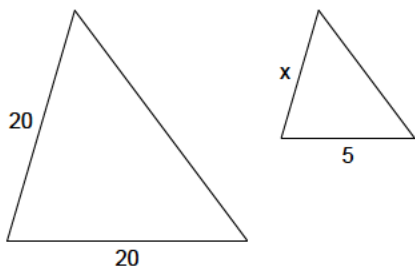

26)

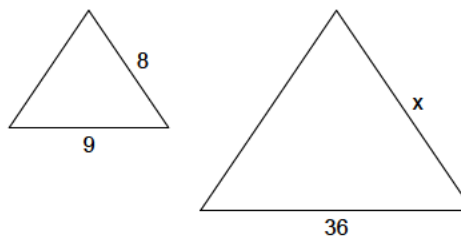

27)

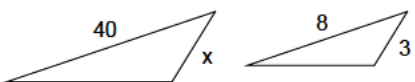

28)

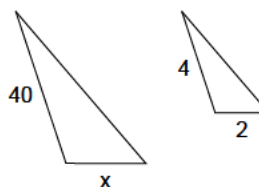

29)

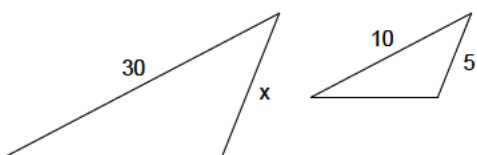

30)

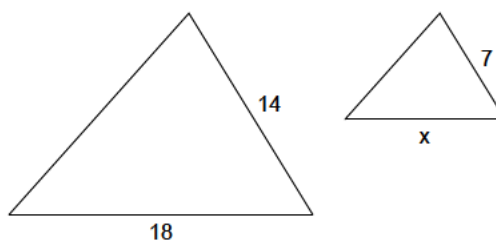

31)

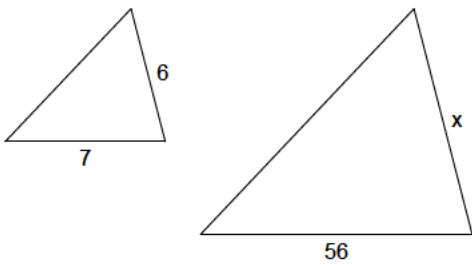

32)

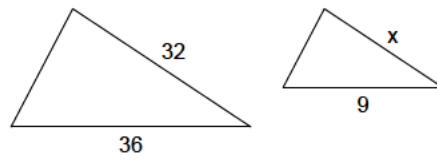

33)

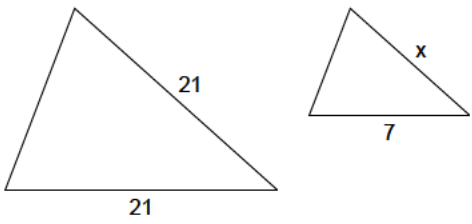

34)

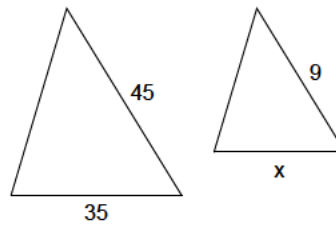

35)

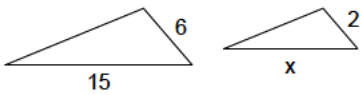

36)

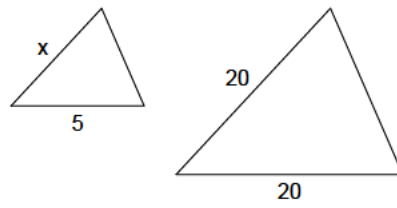

37)

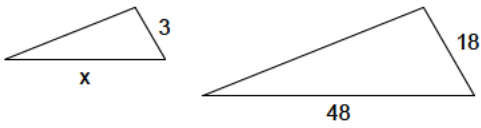

38)

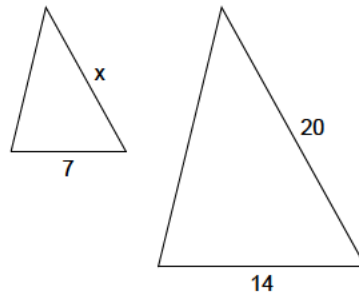

39)

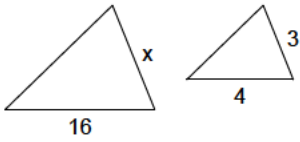

40)

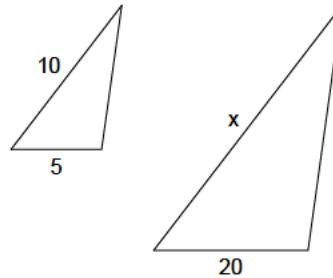

41)

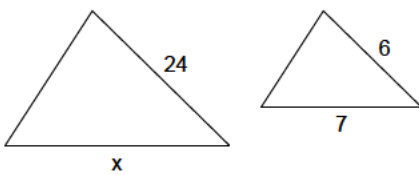

42)

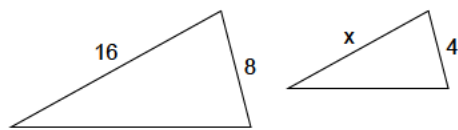

43)

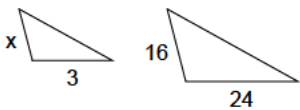

44)

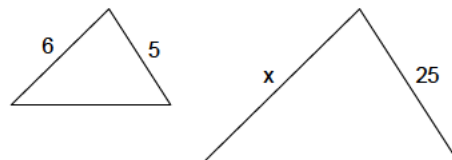

45)

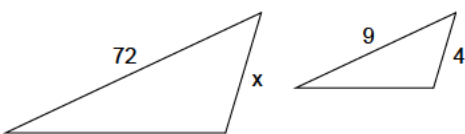

46)

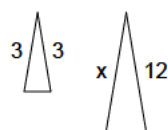

47)

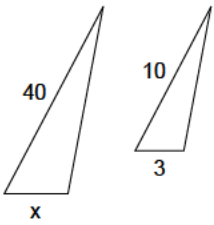

48)

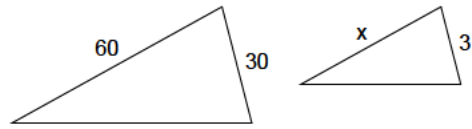

49)

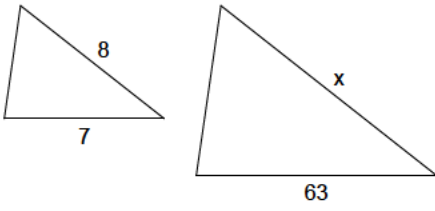

50)

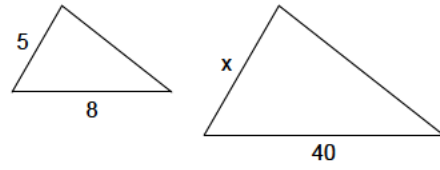

51)

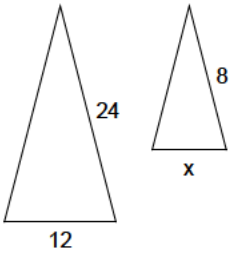

52)

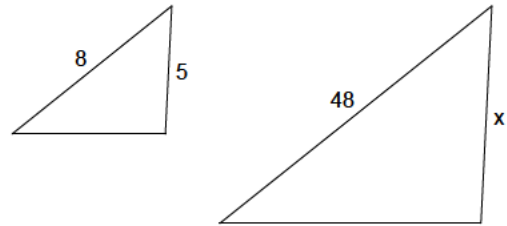

53)

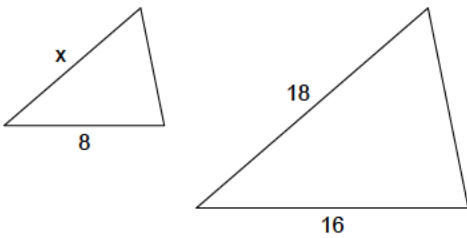

54)

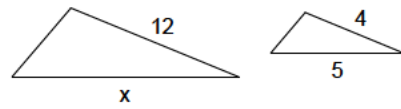

55)

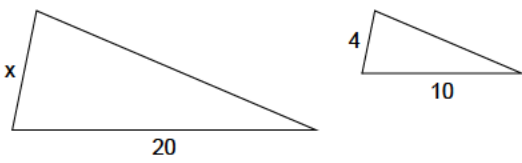

56)

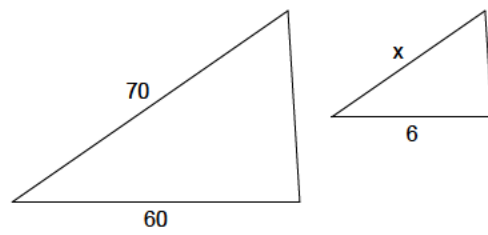

57)

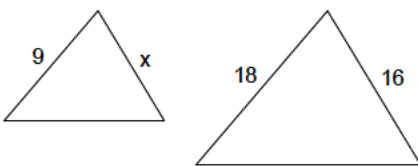

58)

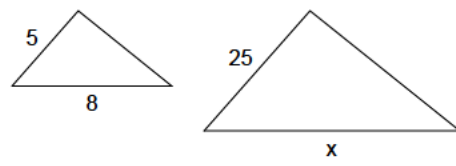

59)

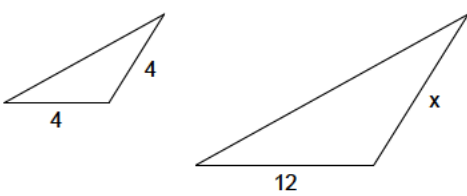

60)

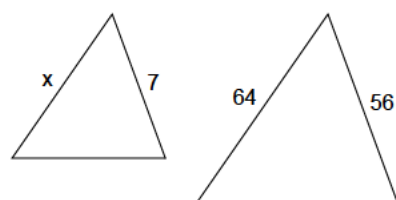

61)

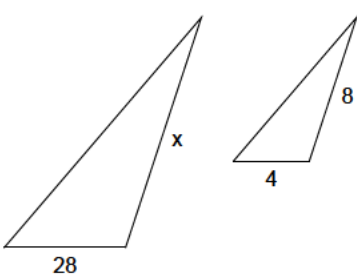

62)

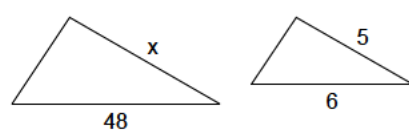

63)

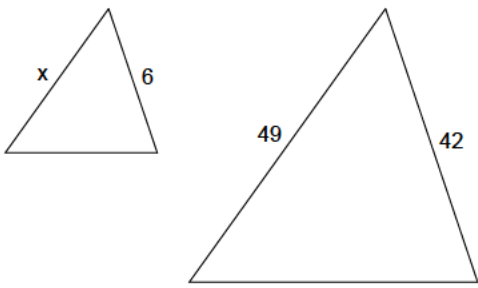

64)

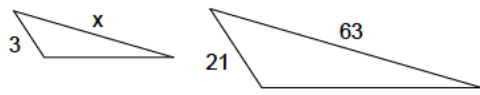

65)

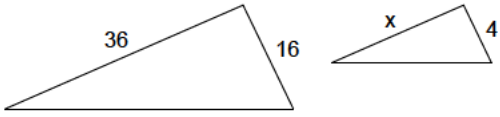

66)

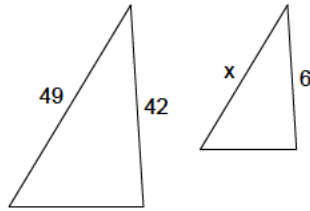

67)



68)

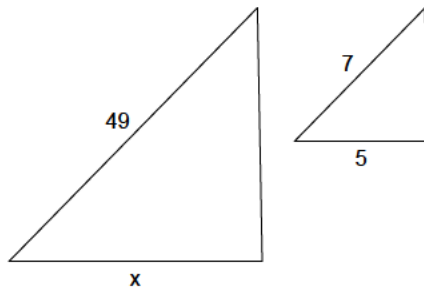

69)

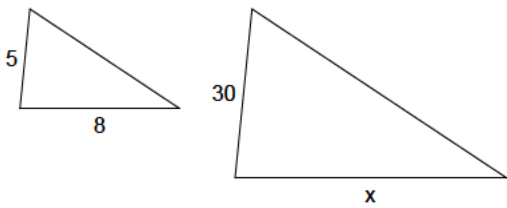

70)

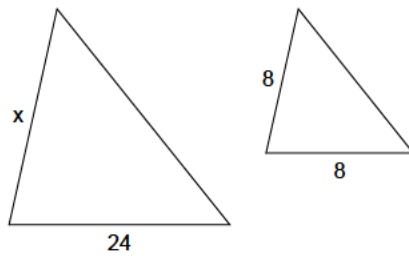

71)

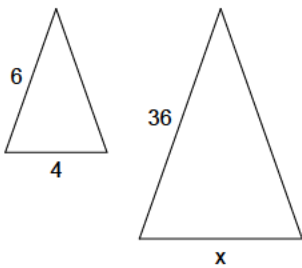

72)

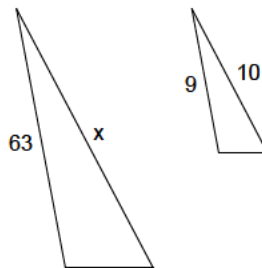

73)

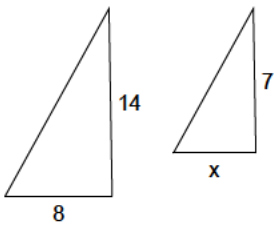

74)

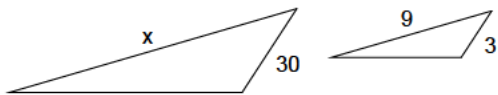

75)

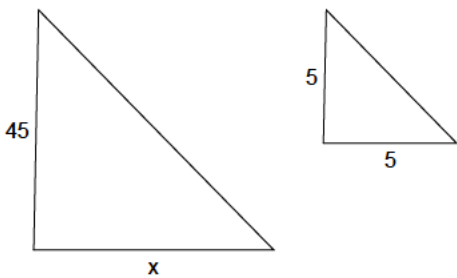

76)

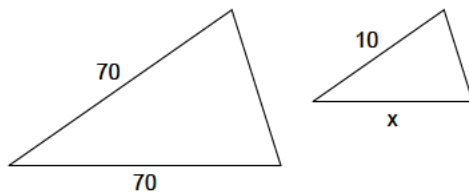

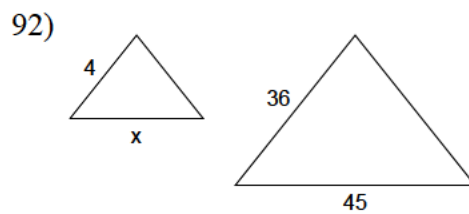
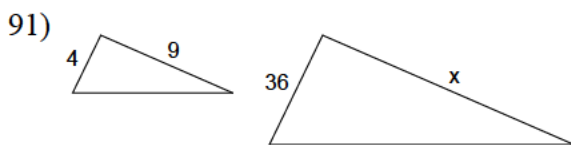
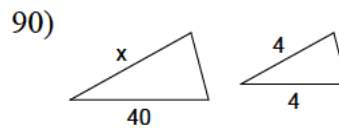
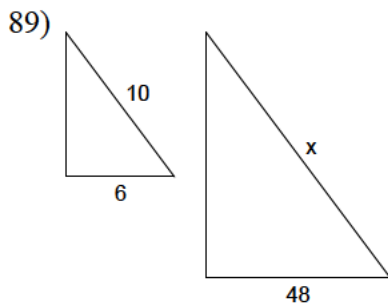
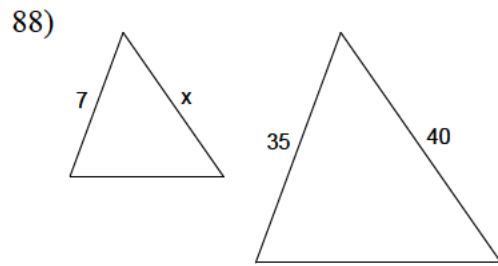
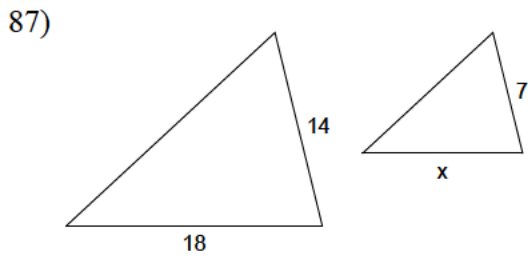
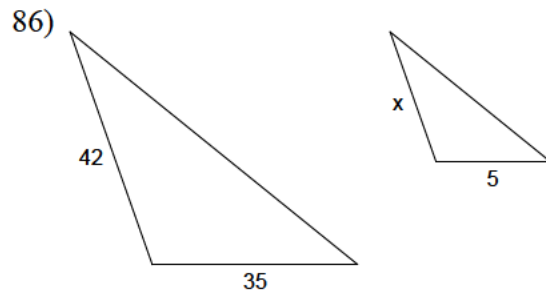
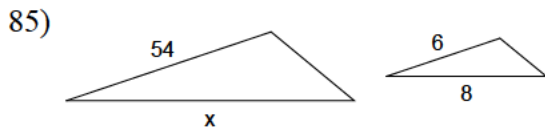
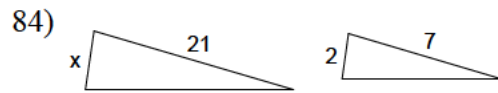
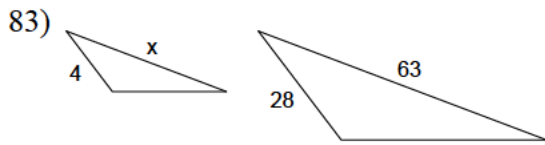
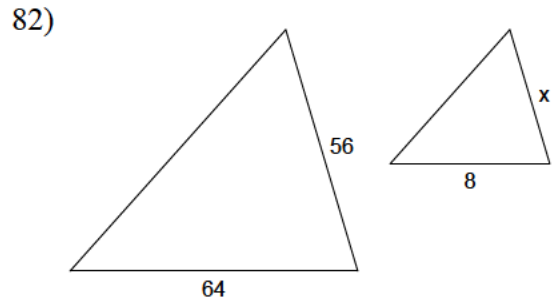
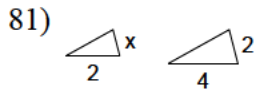
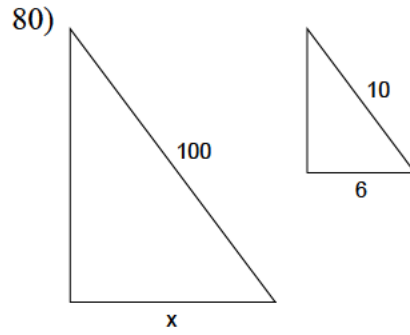
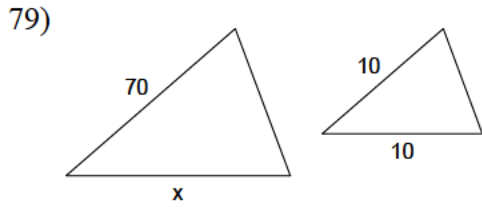
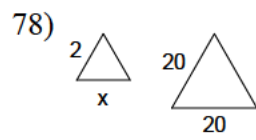
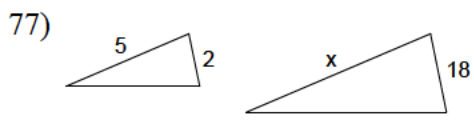

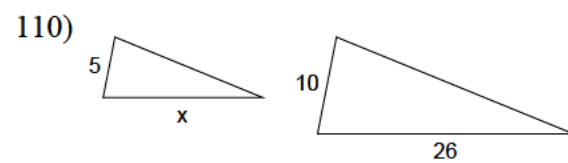
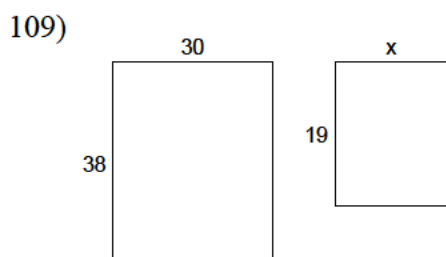
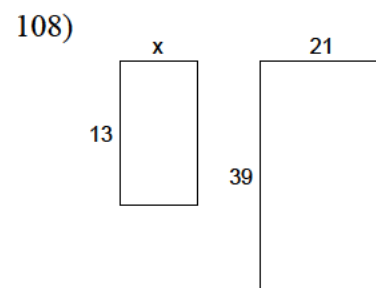
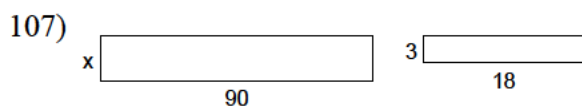
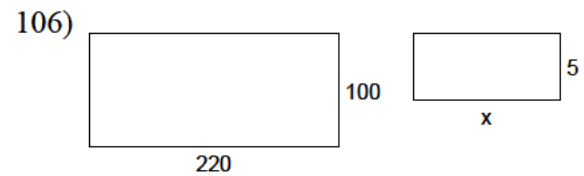
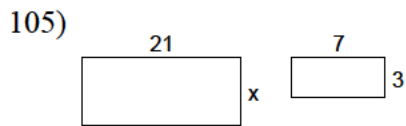
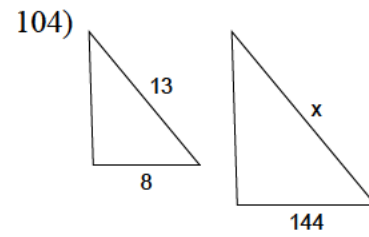
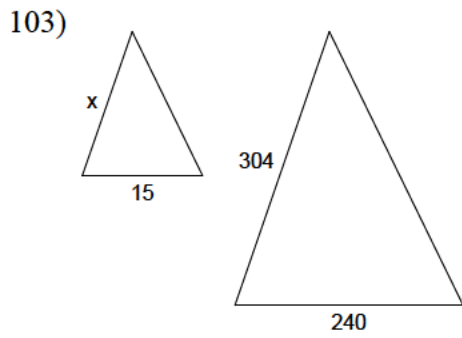
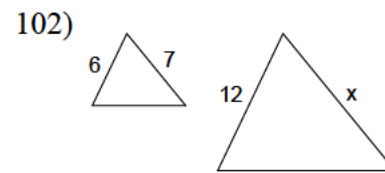
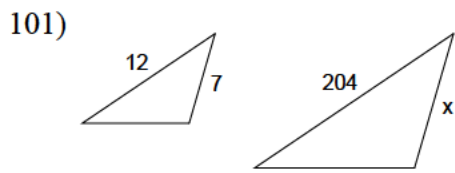
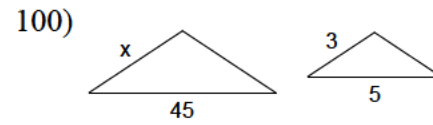
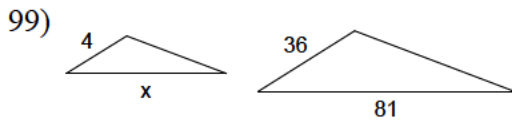
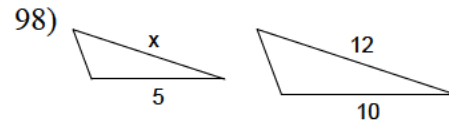
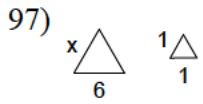
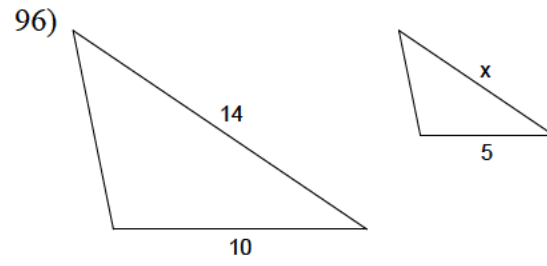
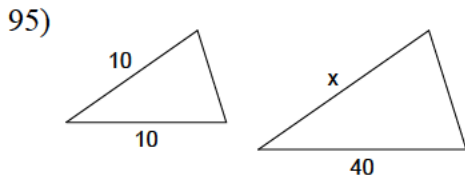
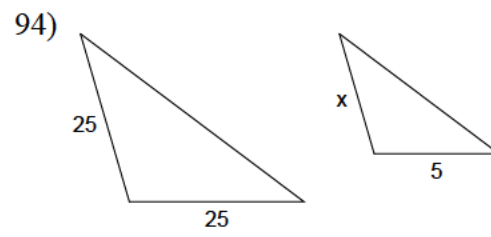
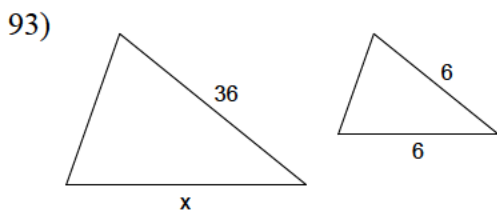

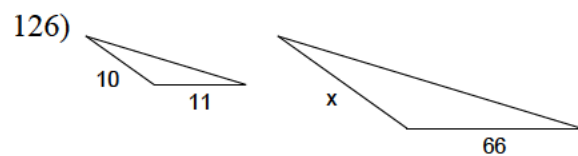
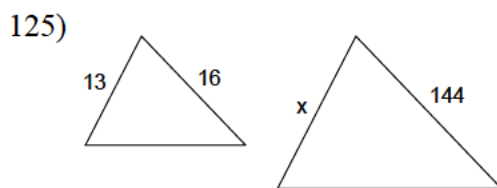
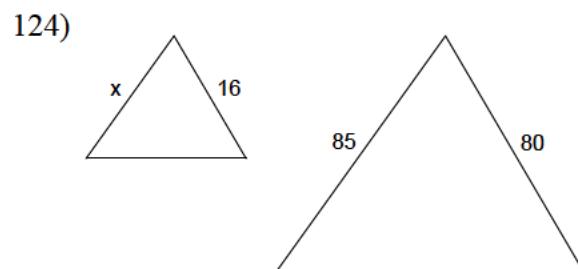
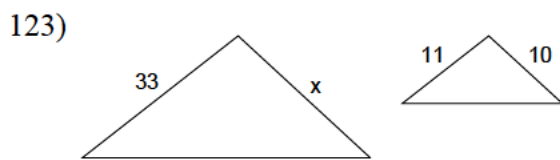
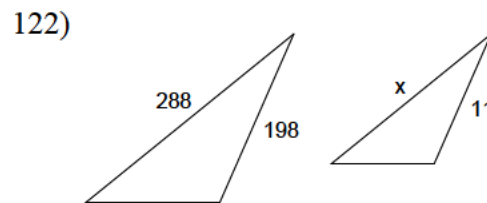
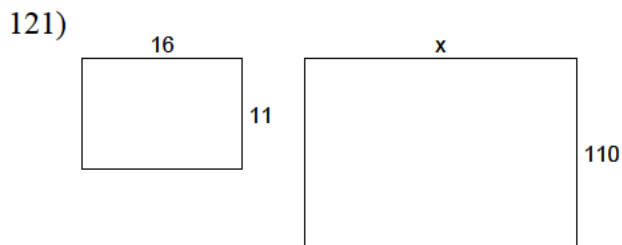
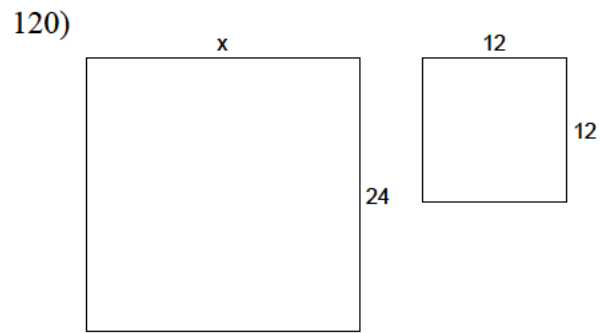
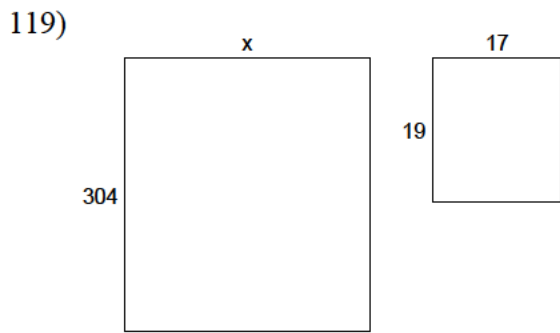
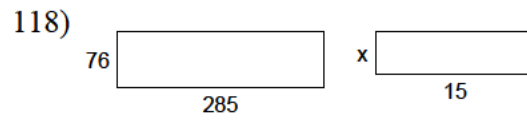
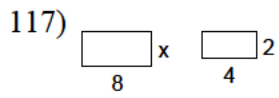
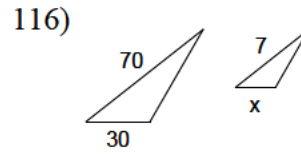
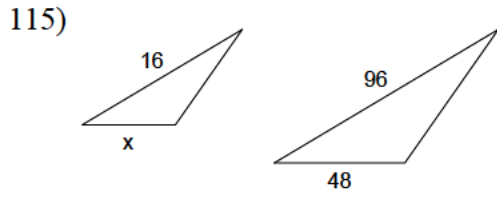
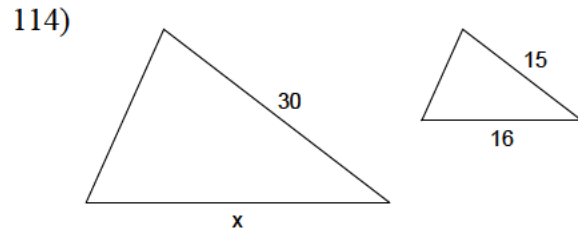
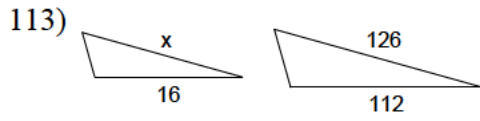
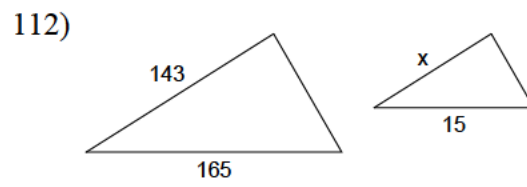
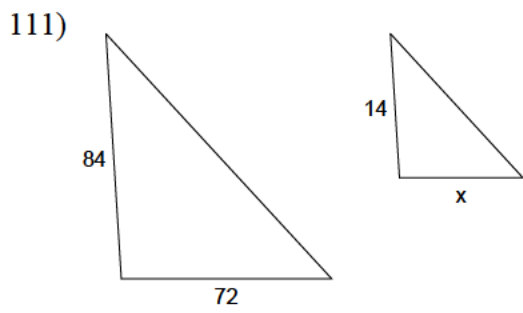

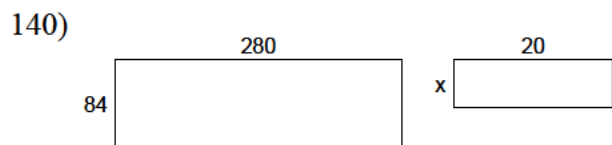
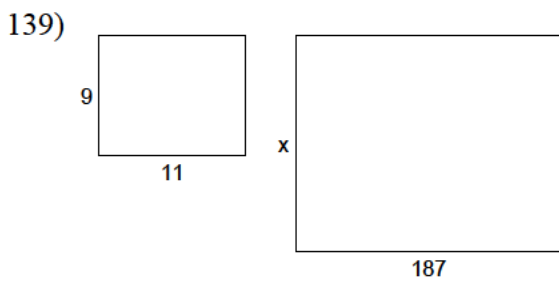
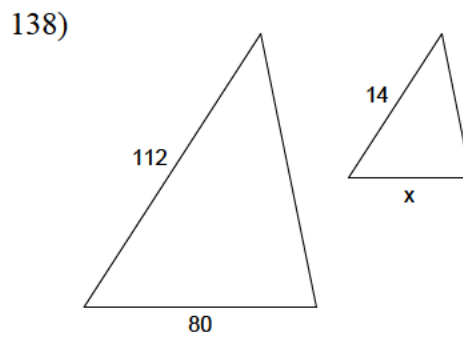
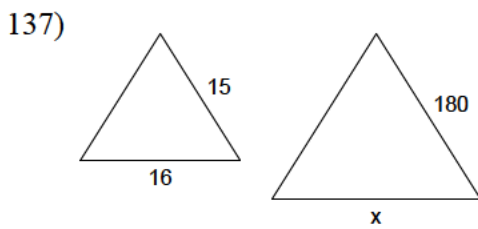
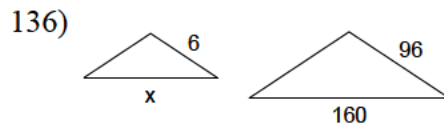
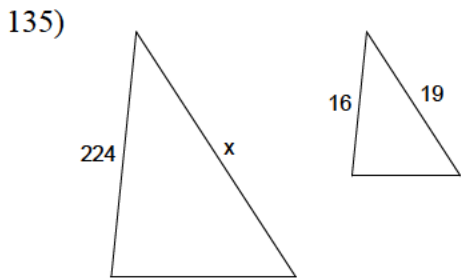
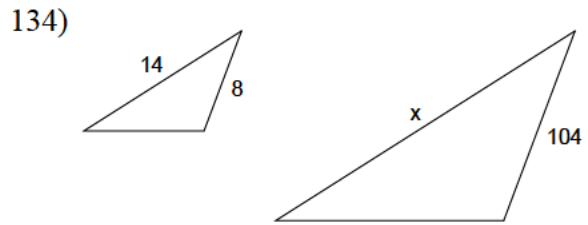
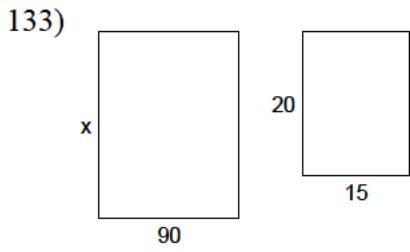
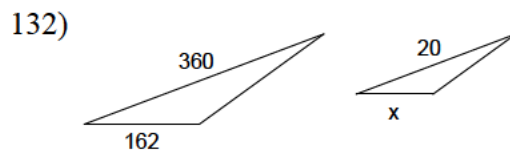
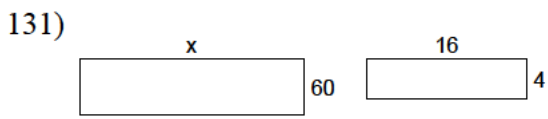
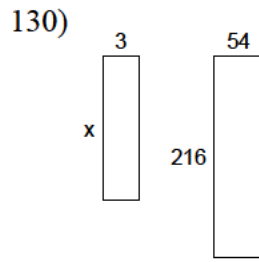
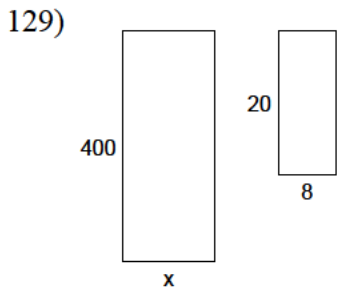
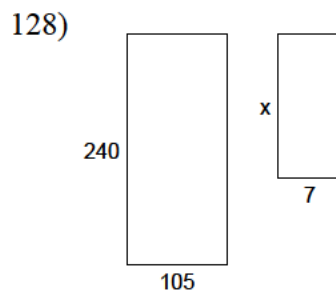
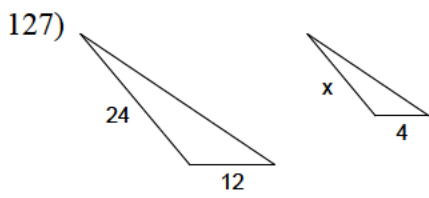

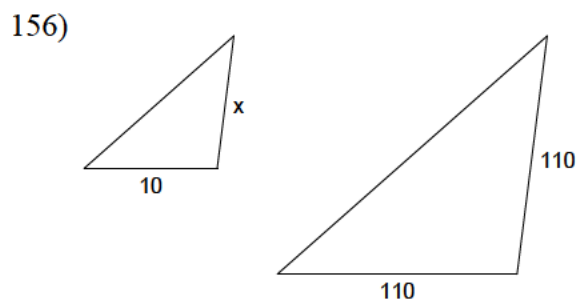
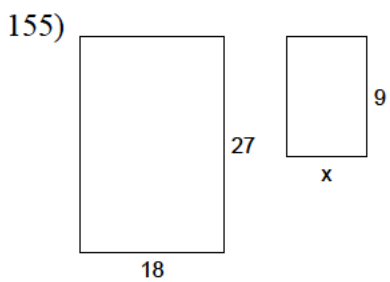
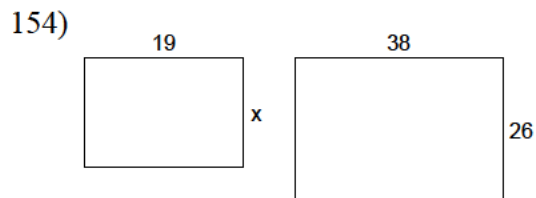
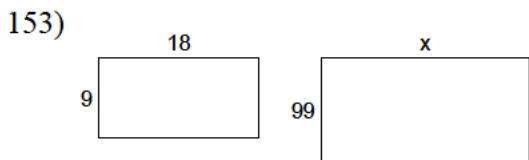
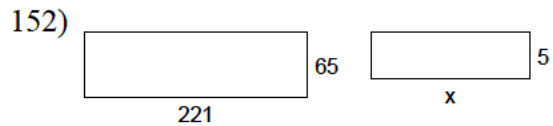
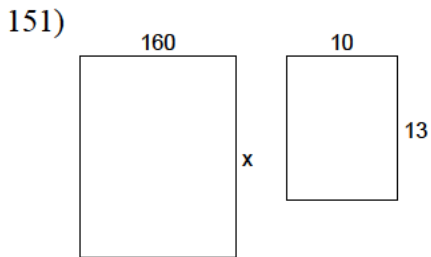
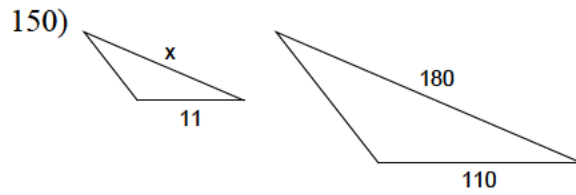
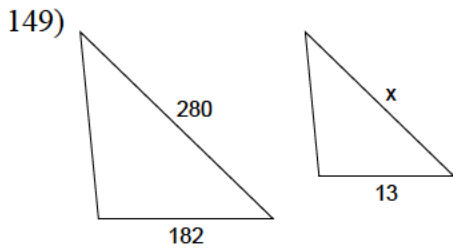
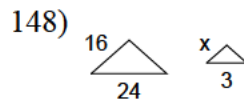
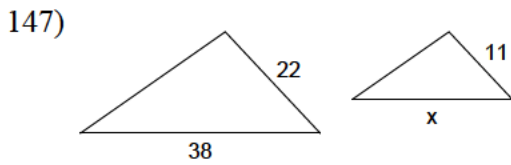
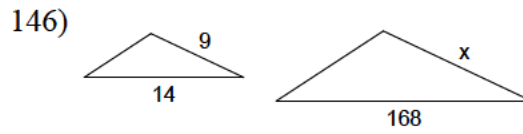
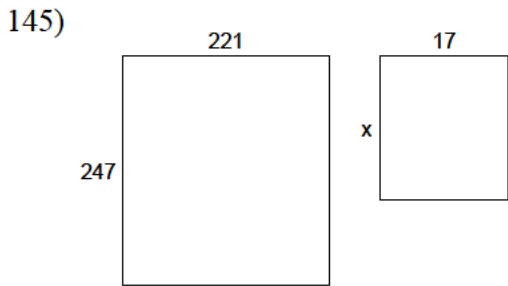
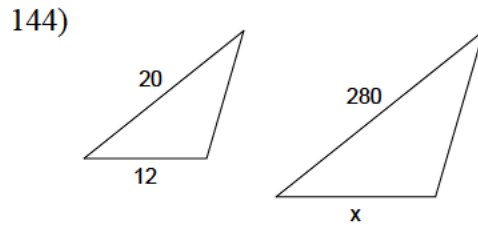
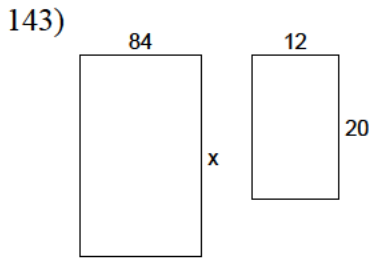
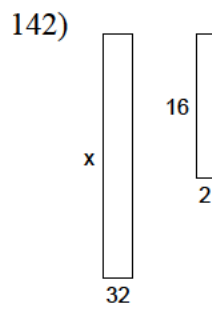
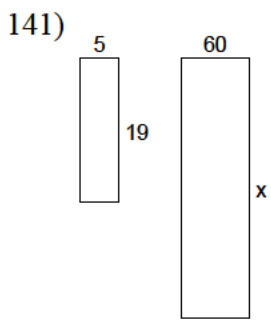

157)

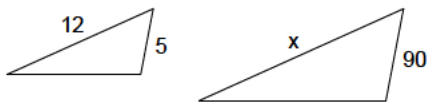

158)

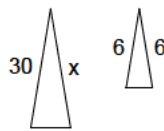

159)

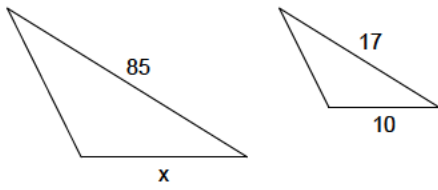

160)

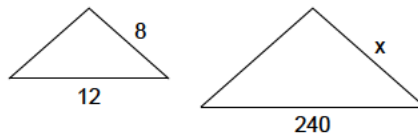

161)

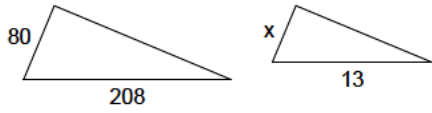

162)

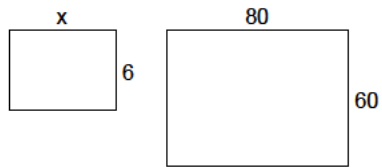

163)

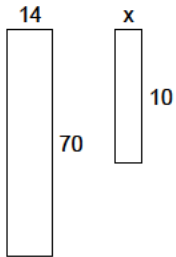

164)

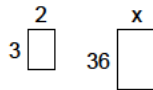

165)

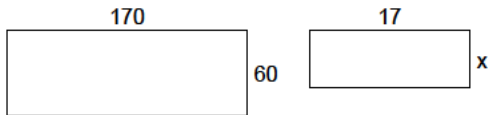

166)

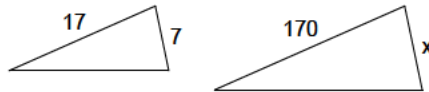

167)



168)

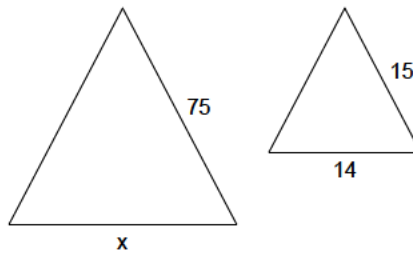

169)



170)

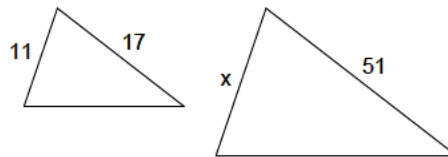

171)

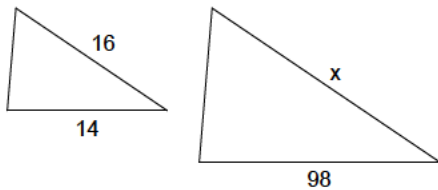

172)

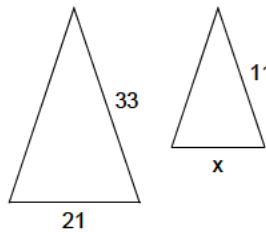

173)

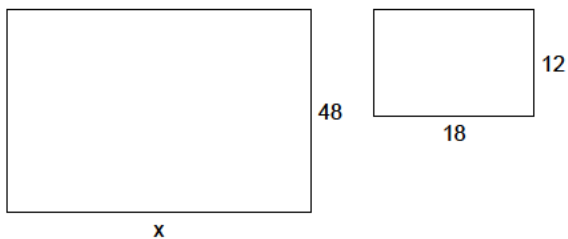

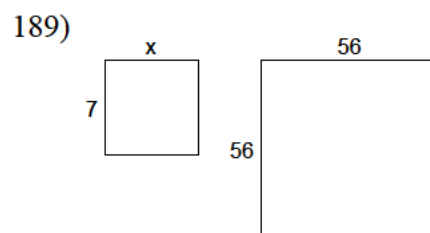
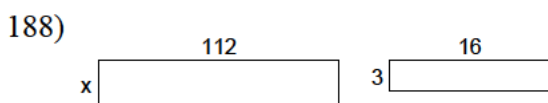
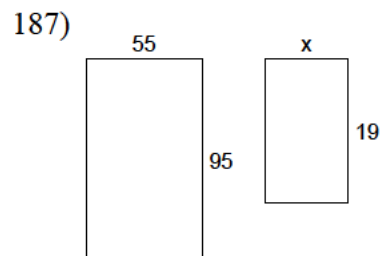
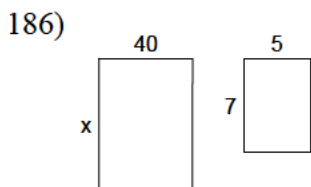
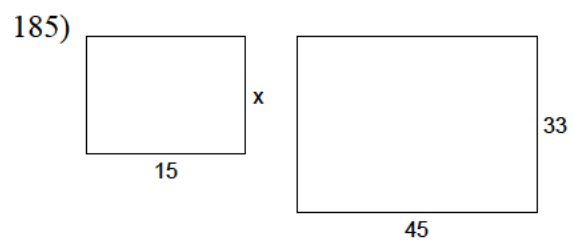
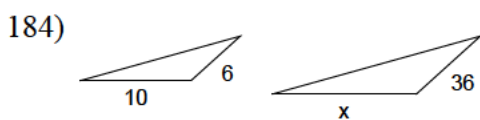
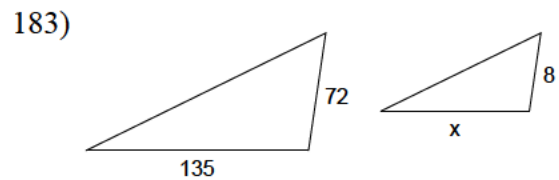
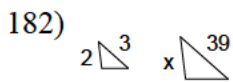
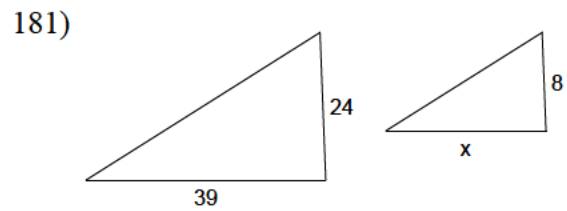
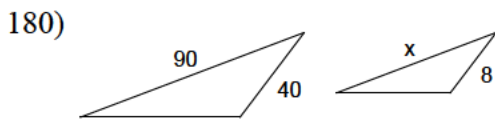
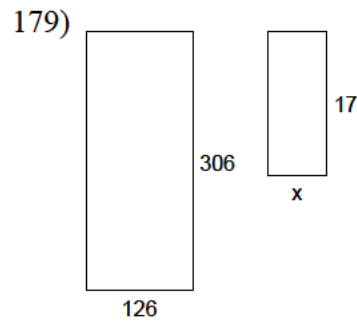
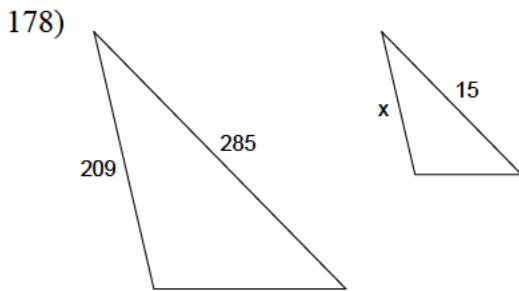
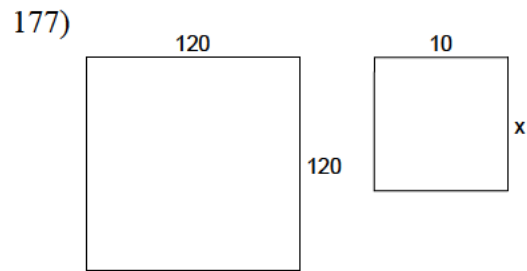
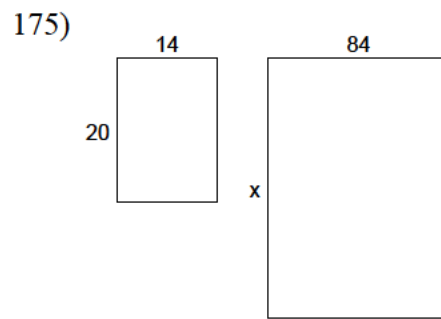
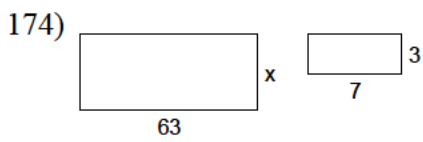

190)

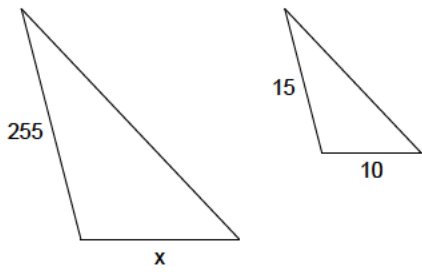

191)

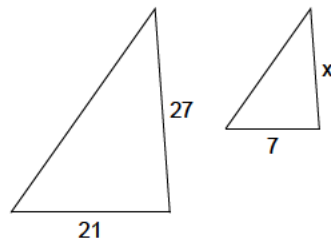

192)

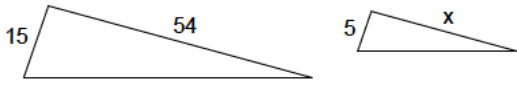

193)

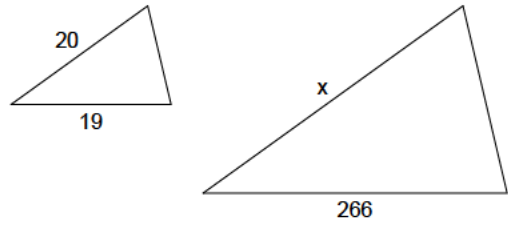

194)

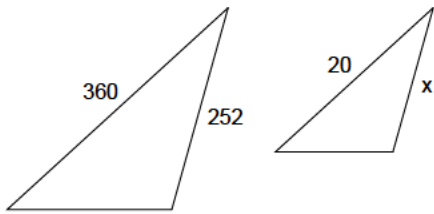

195)

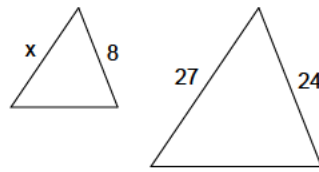

196)

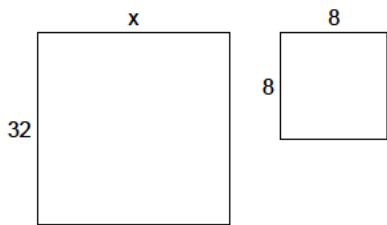

197)

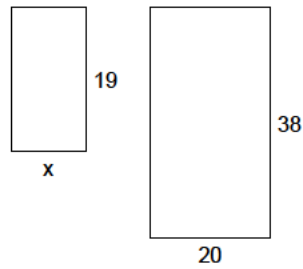

198)

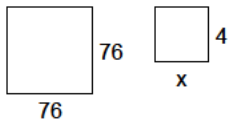

199)

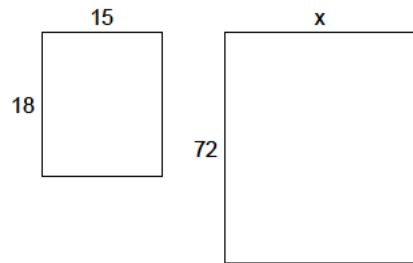

200)

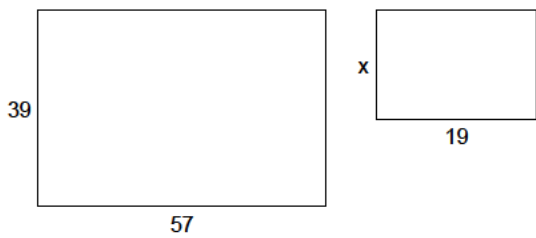

201)

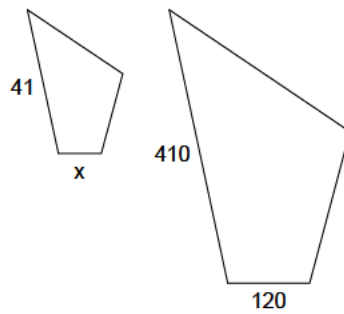

202)

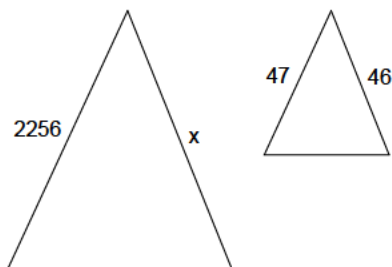

203)

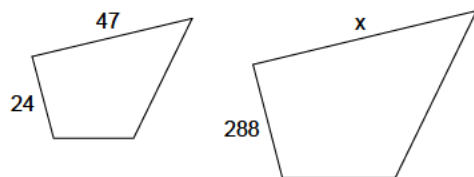

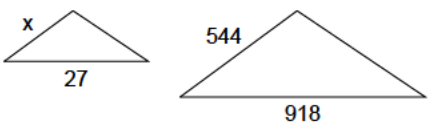
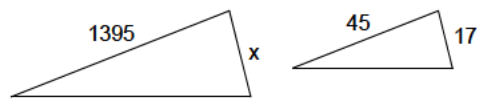
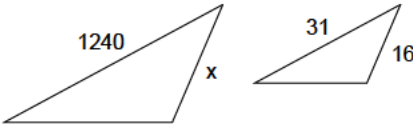
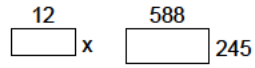
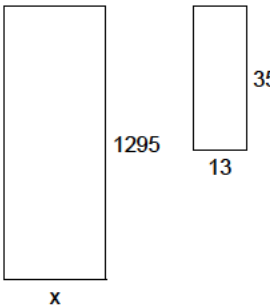
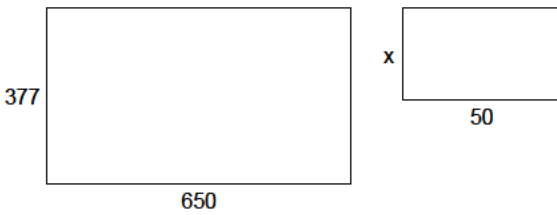
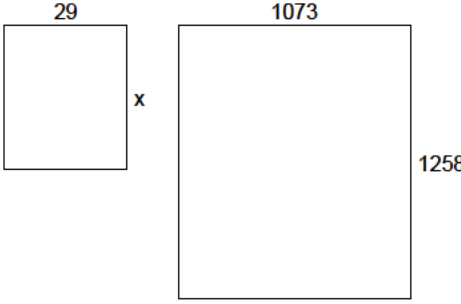
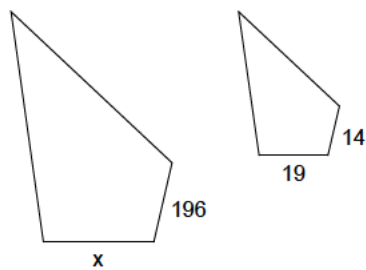
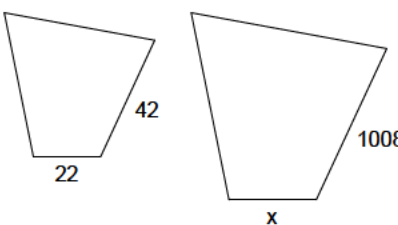
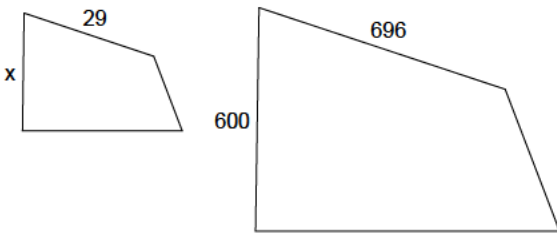
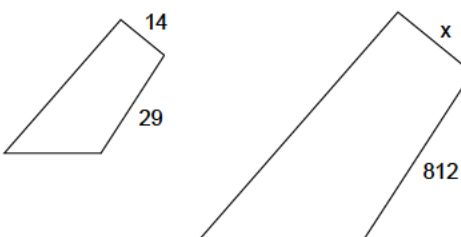
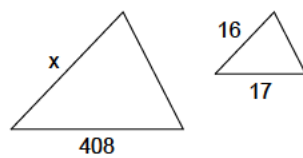
- 204) 
- 205) 
- 206) 
- 207) 
- 208) 
- 209) 
- 210) 
- 211) 
- 212) 
- 213) 
- 214) 
- 215) 

216)

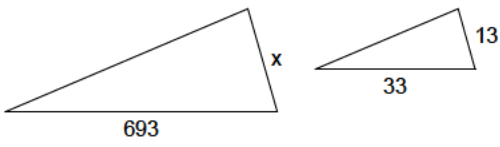

217)

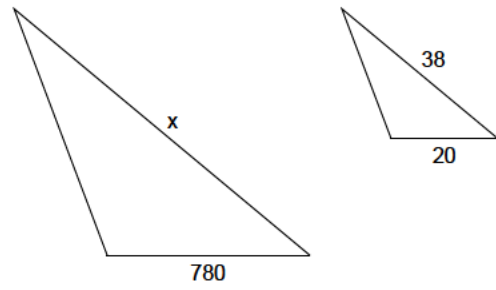

218)

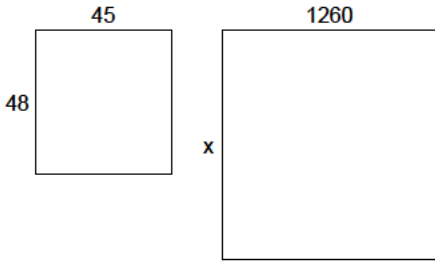

219)

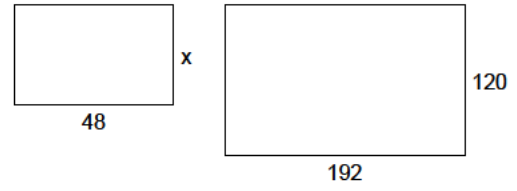

220)

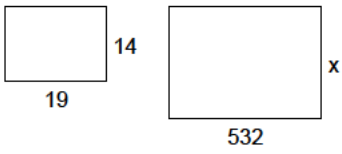

221)

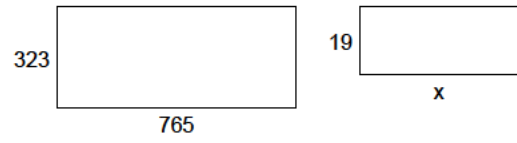

222)

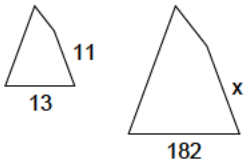

223)

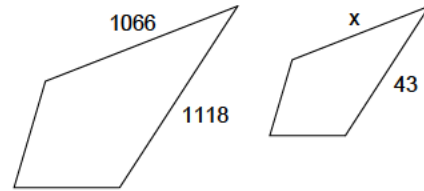

224)

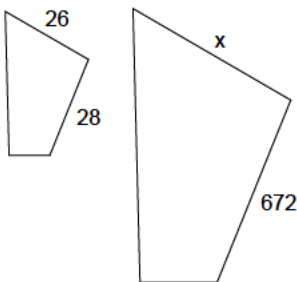

225)

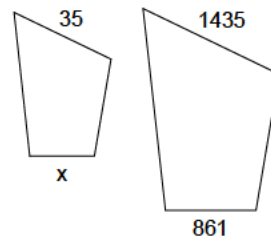

226)

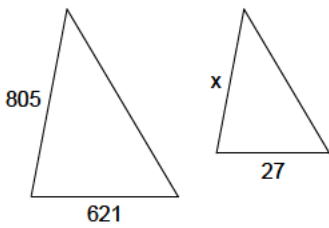

227)

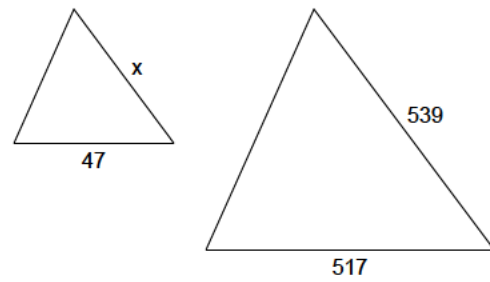

228)

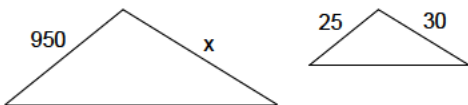

229)

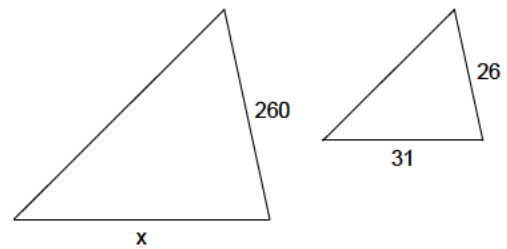

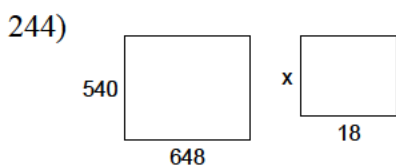
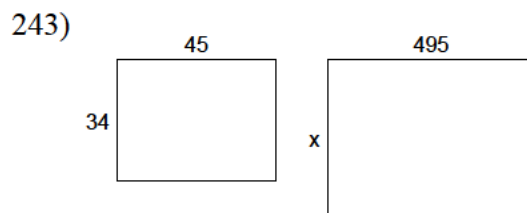
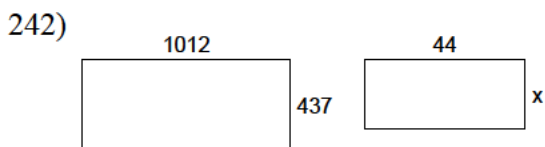
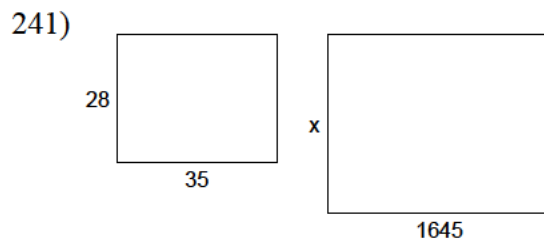
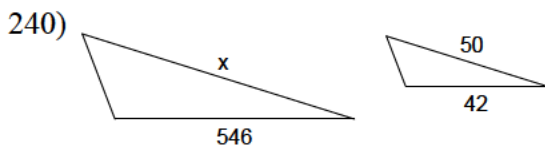
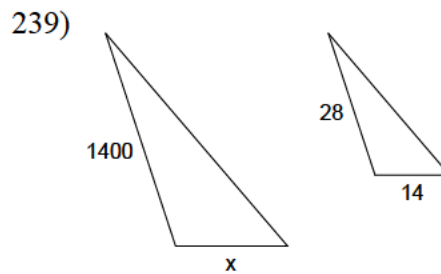
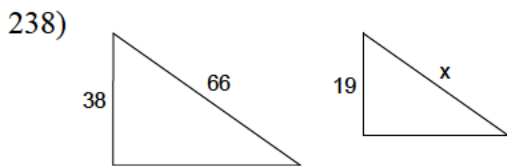
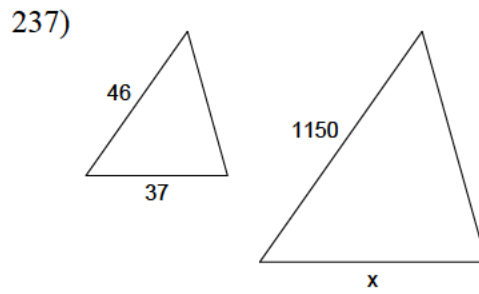
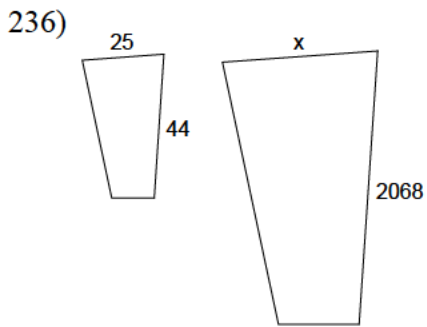
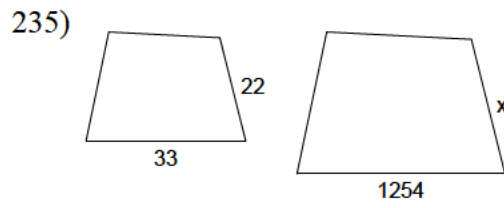
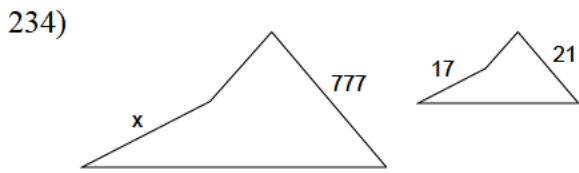
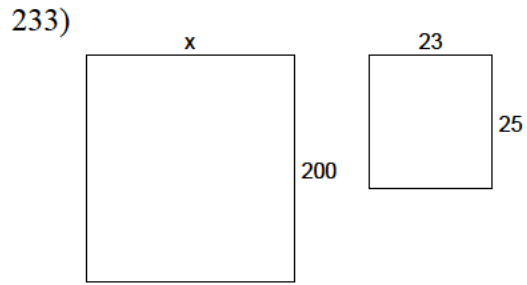
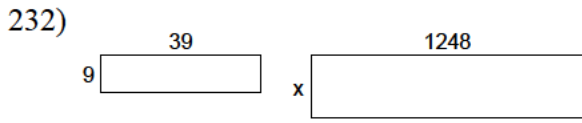
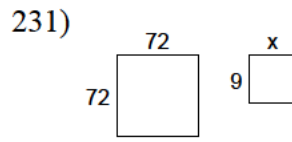
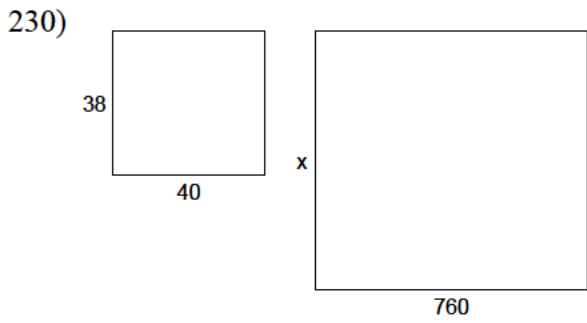

245)

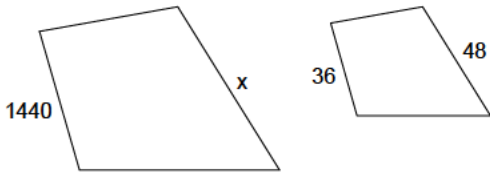

246)

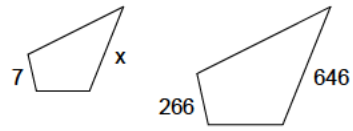

247)

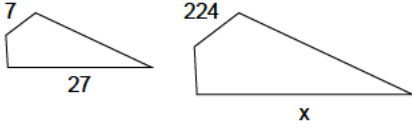

248)

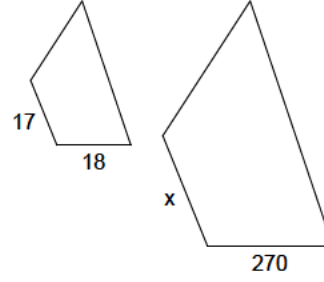

249)

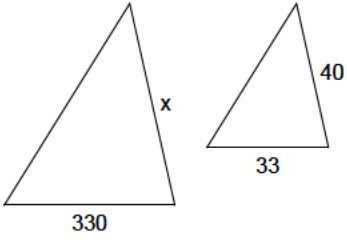

250)

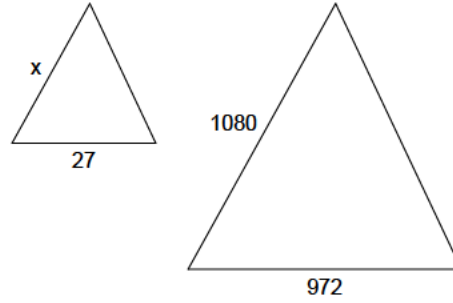

251)

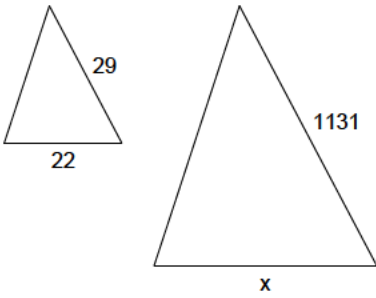

252)

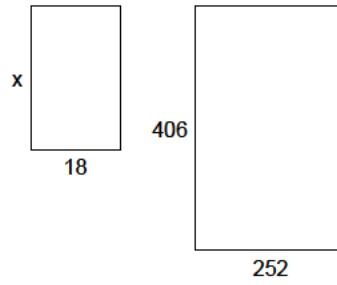

253)

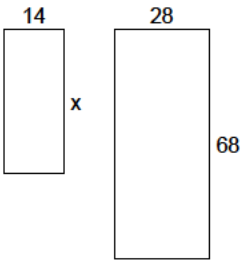

254)

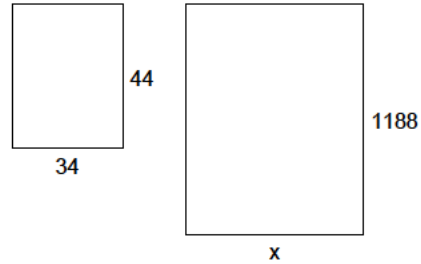

255)

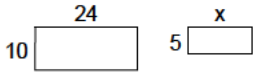

256)

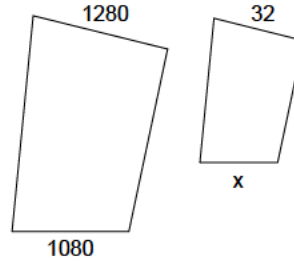

257)

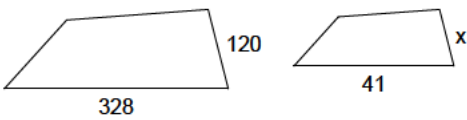

258)

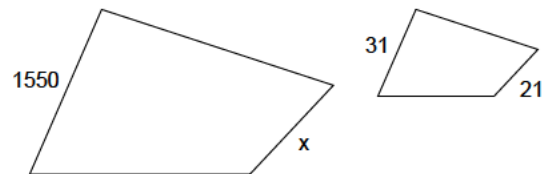

259)

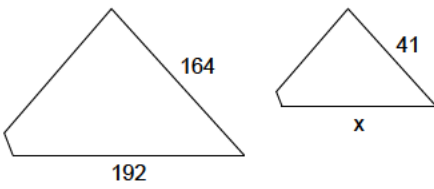

260)

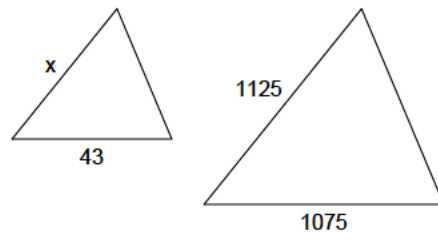

261)

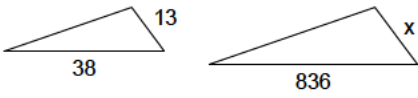

262)

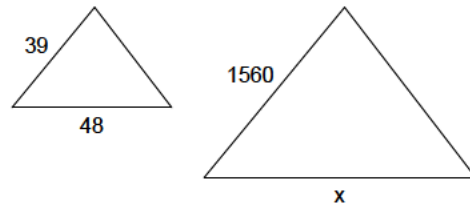

263)

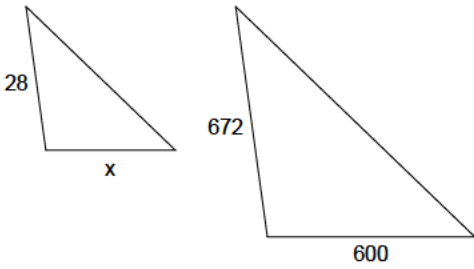

264)

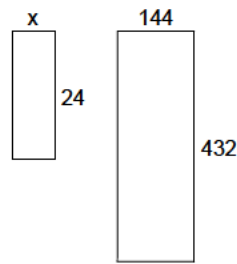

265)

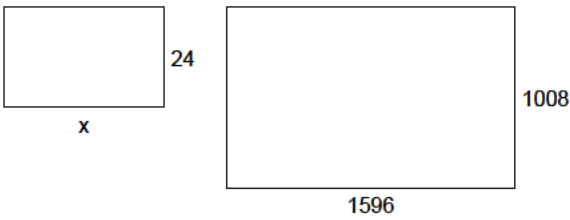

266)

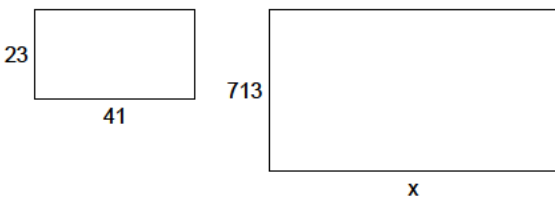

267)

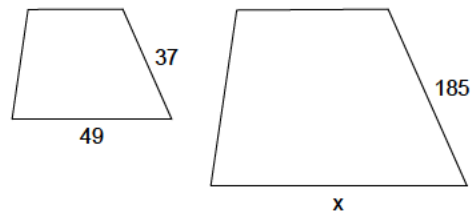

268)

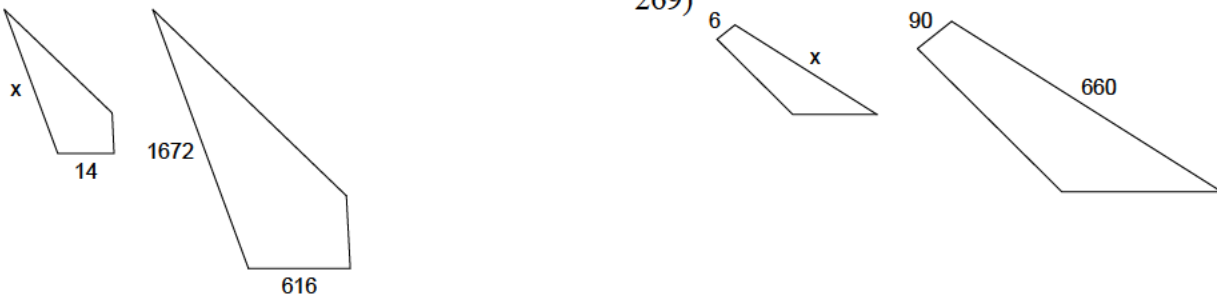

269)

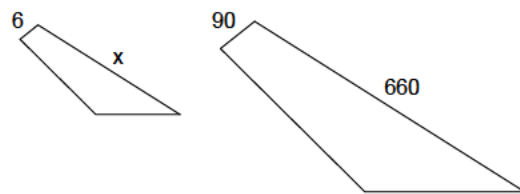

270)

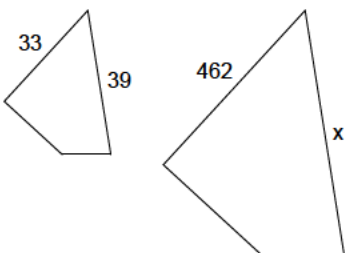

271)

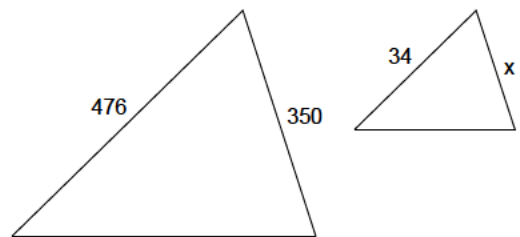

272)

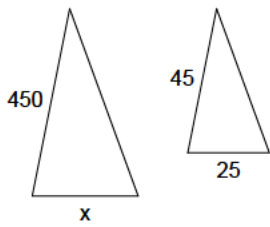

273)

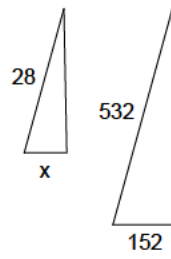

274)

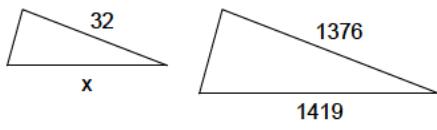

275)

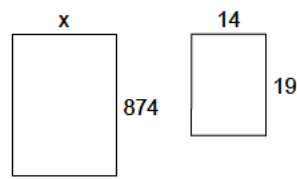

276)

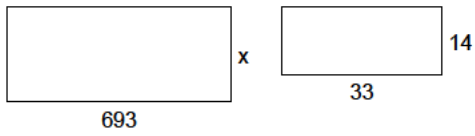

277)

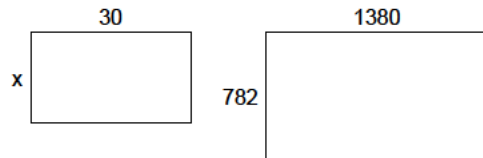

278)

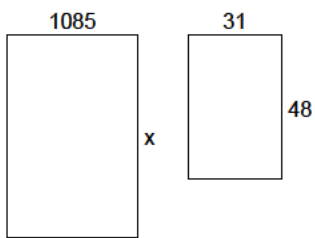

279)

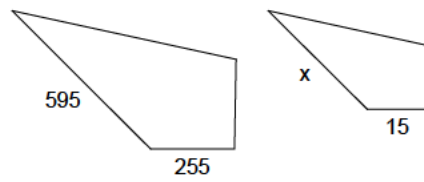

280)

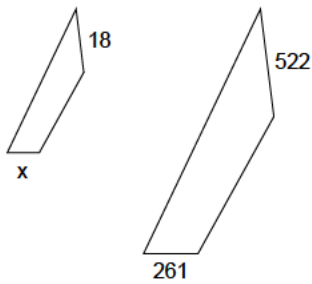

281)

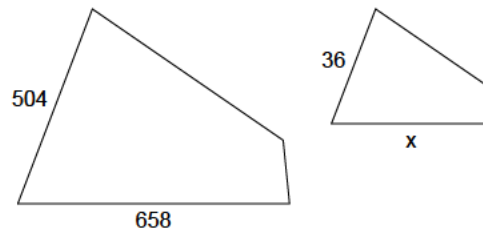

282)

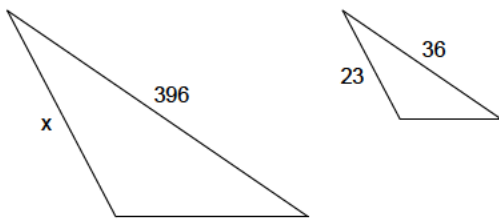

283)

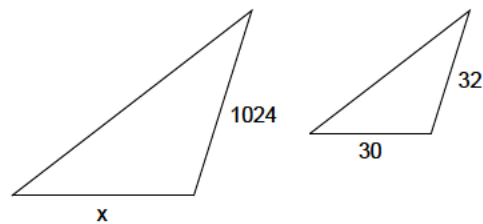

284)

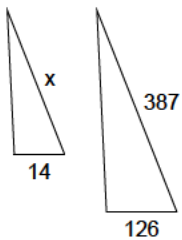

285)

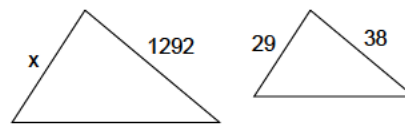

286)

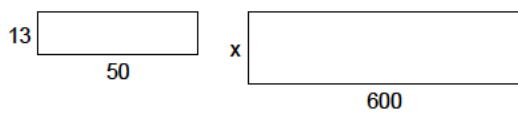

287)

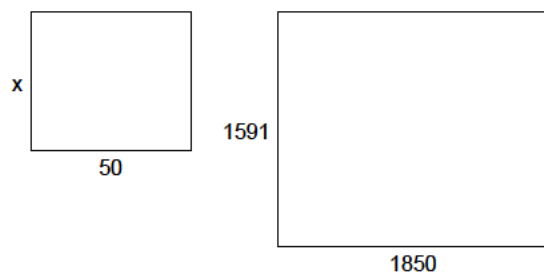

288)

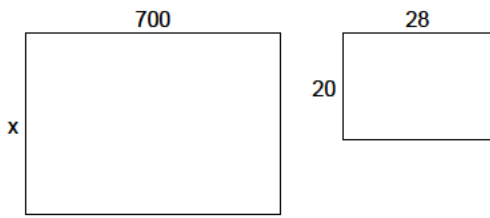

289)

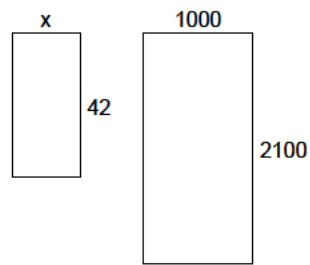

290)

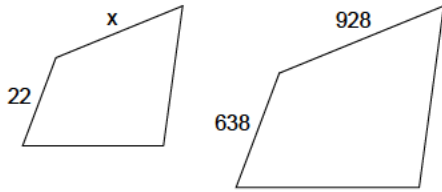

291)

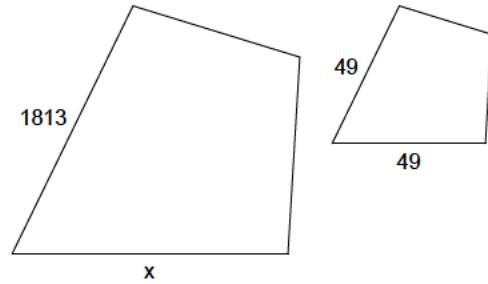

292)

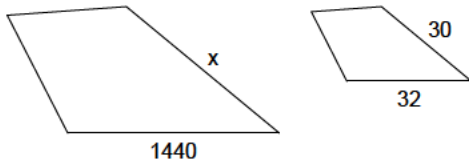

293)

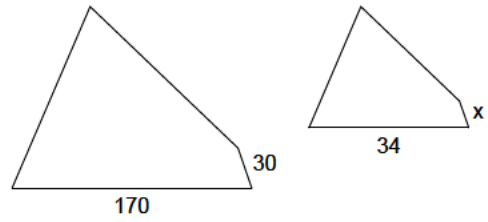

294)

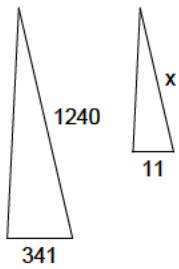

295)

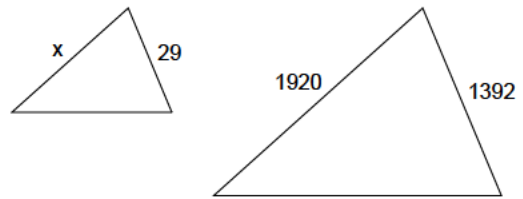

296)

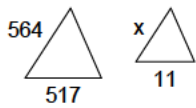

297)

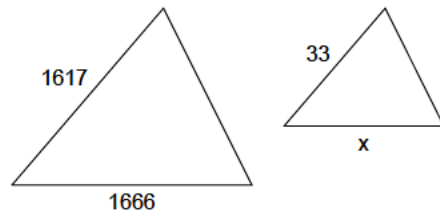

298)

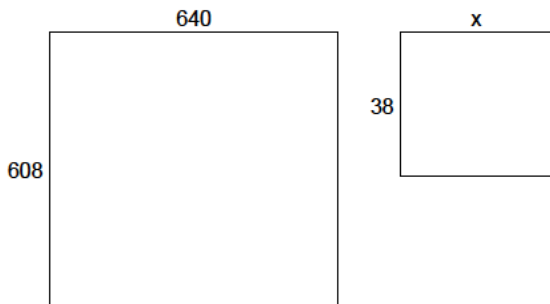

299)

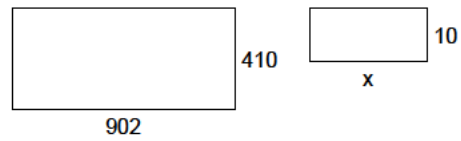

300)

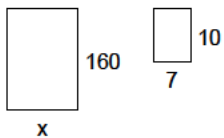

Proportions - similar figures - integers

Pairs are similar. Try to find a pair:

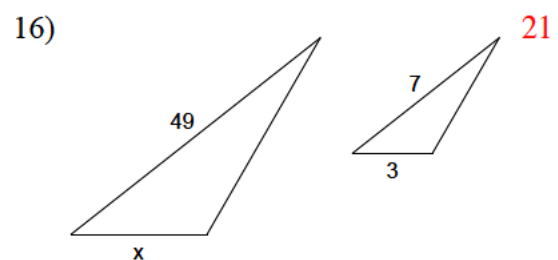
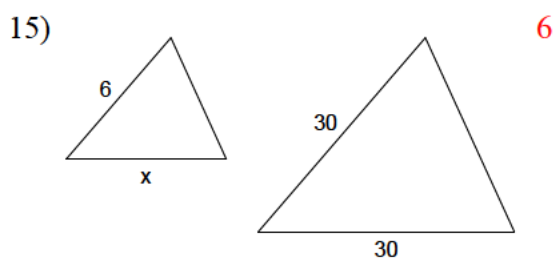
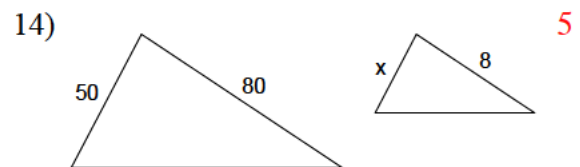
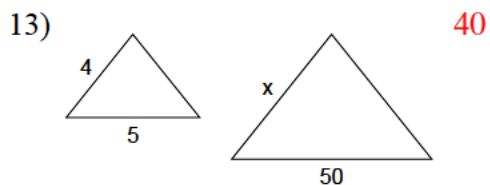
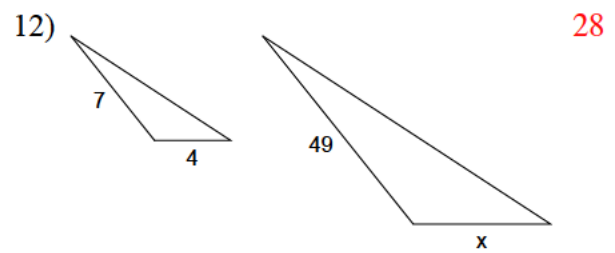
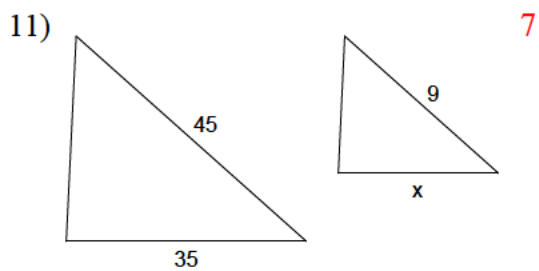
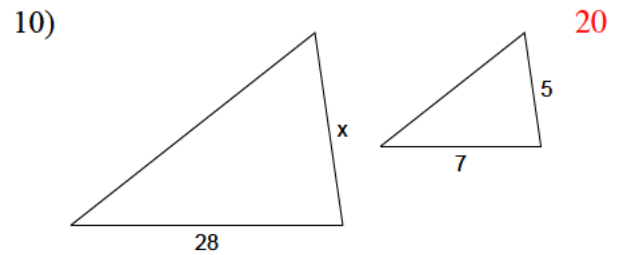
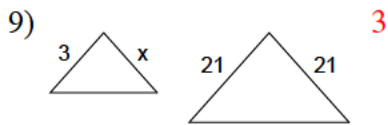
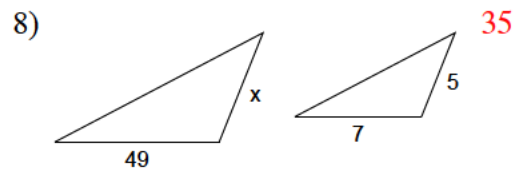
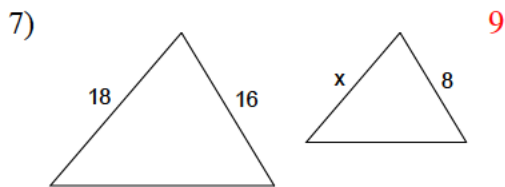
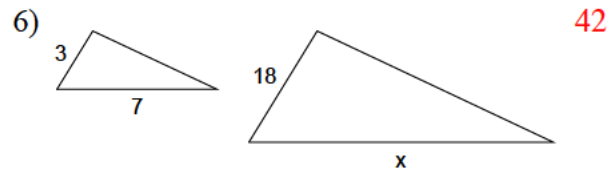
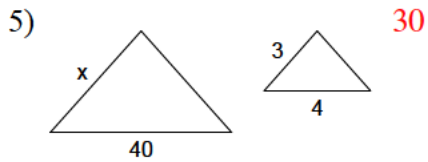
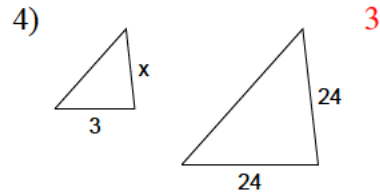
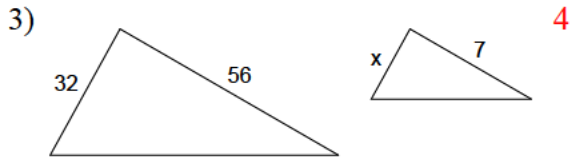
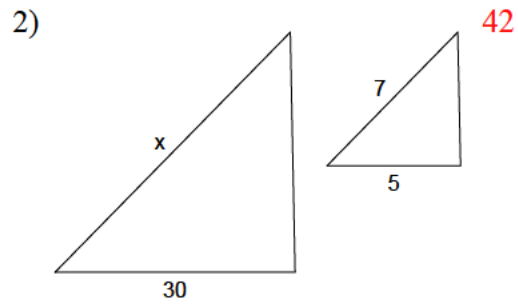
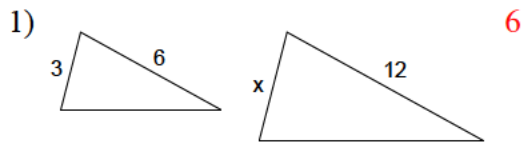

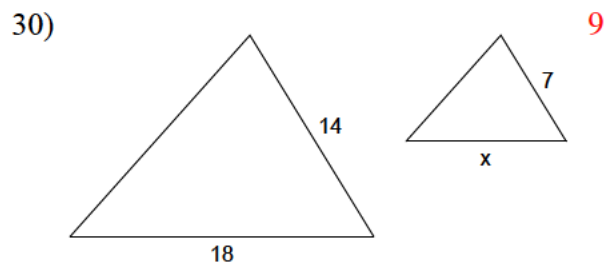
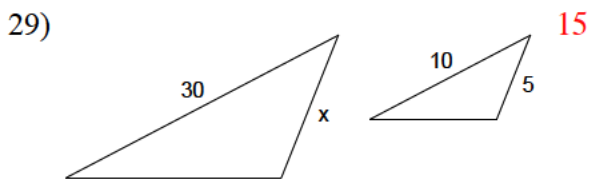
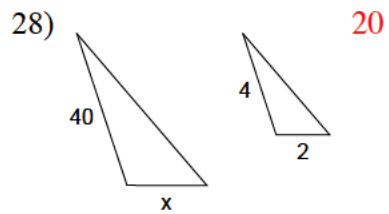
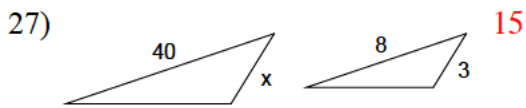
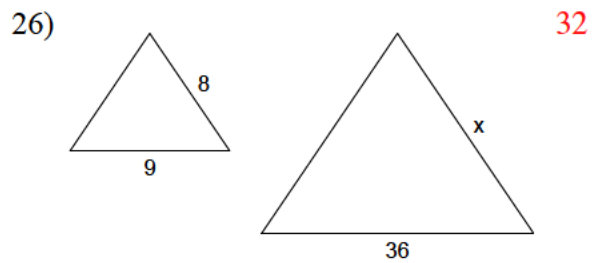
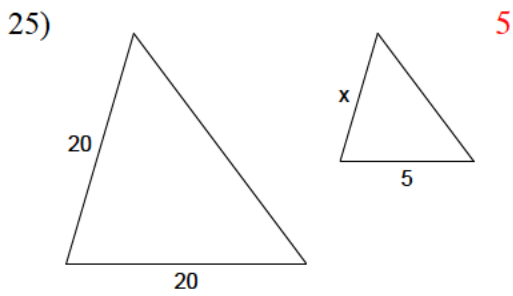
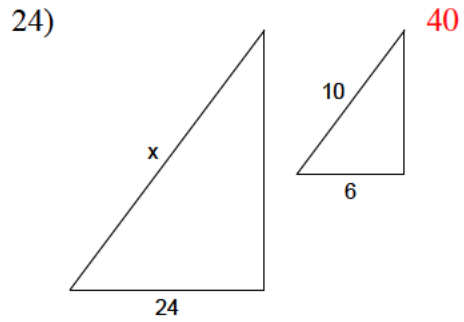
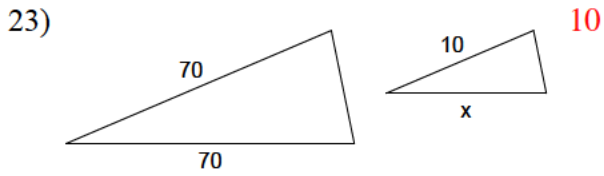
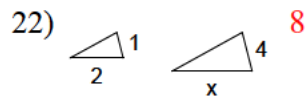
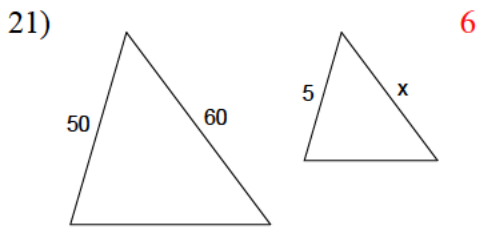
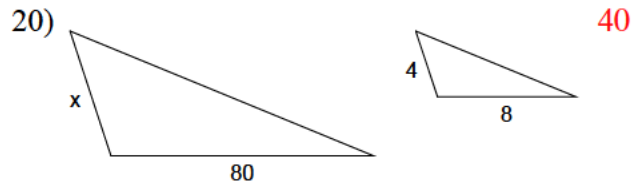
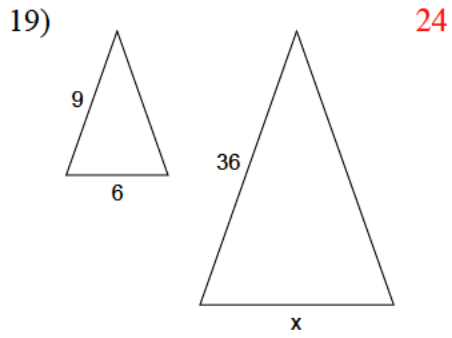
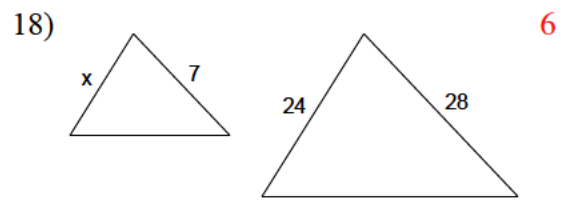
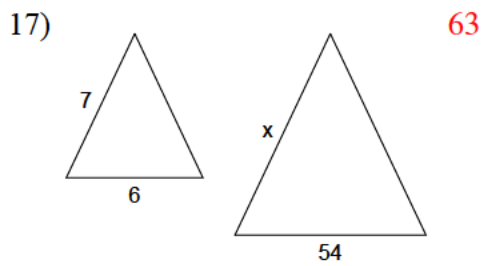

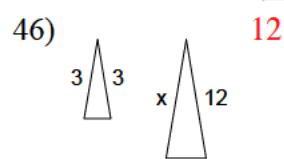
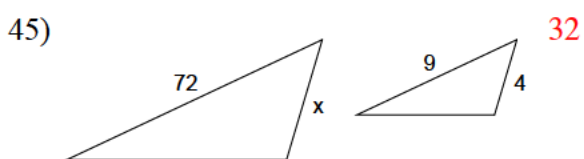
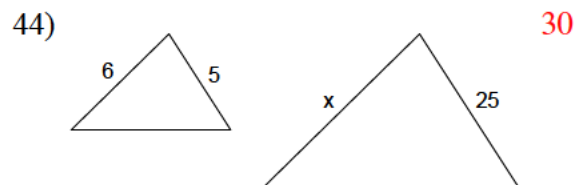
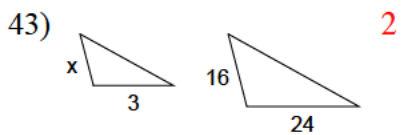
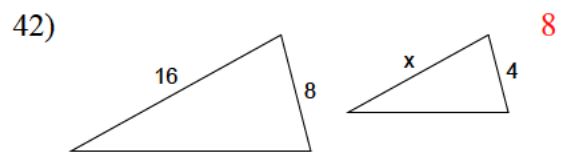
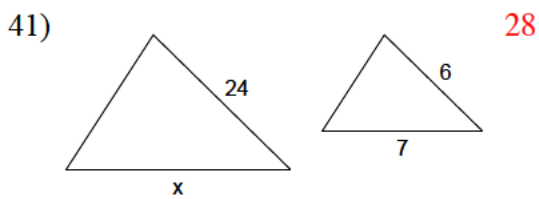
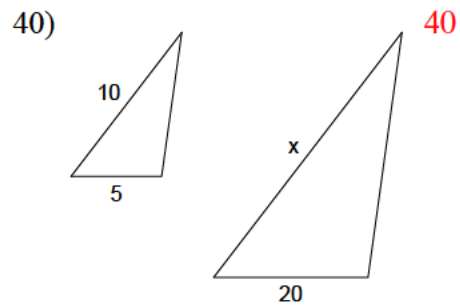
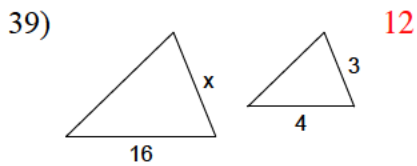
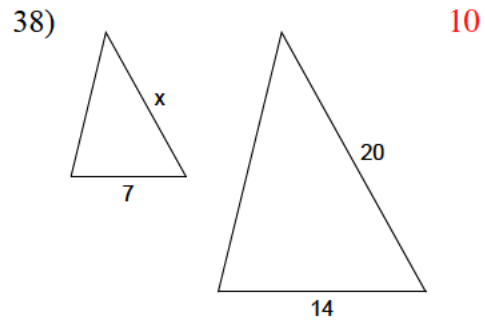
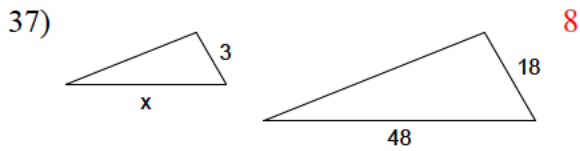
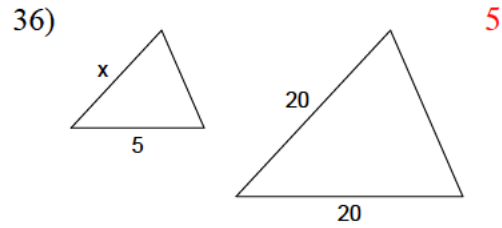
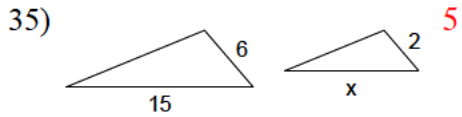
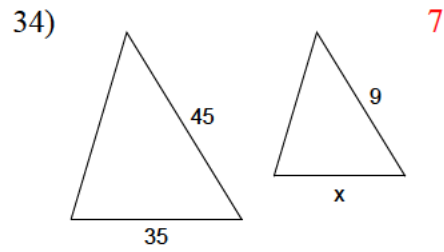
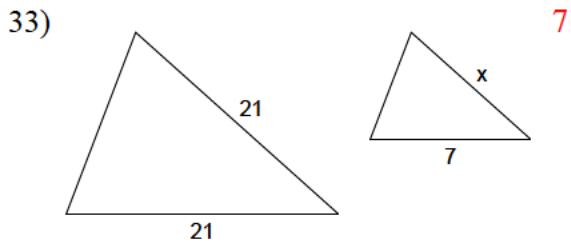
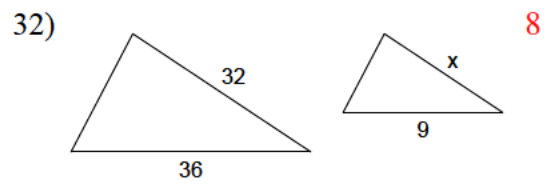
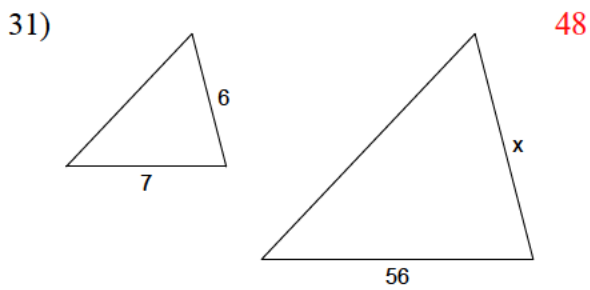

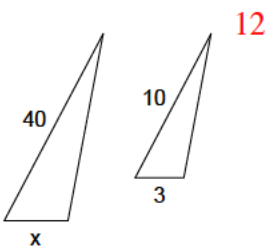
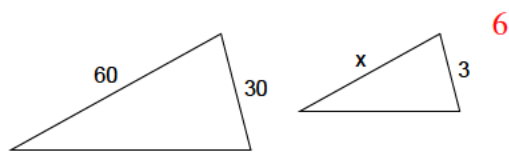
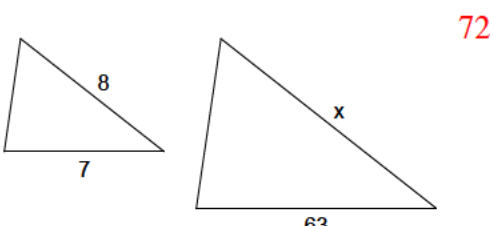
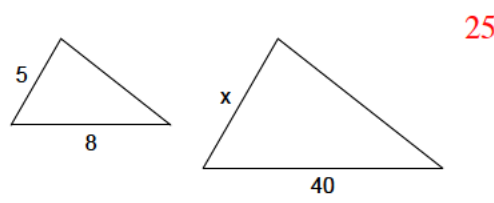
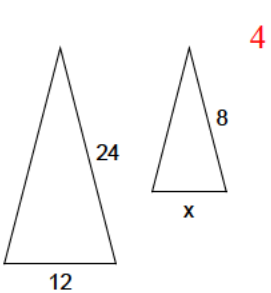
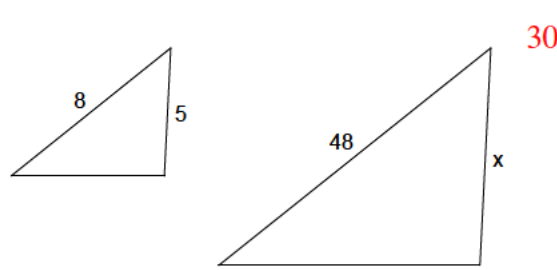
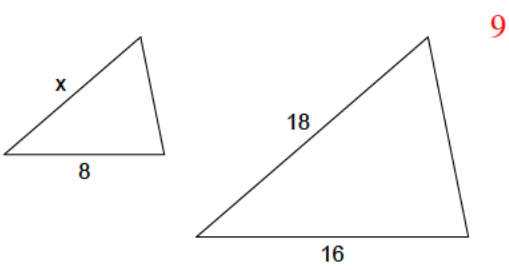
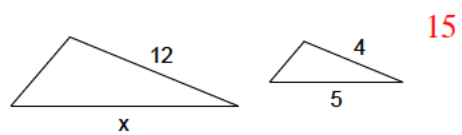
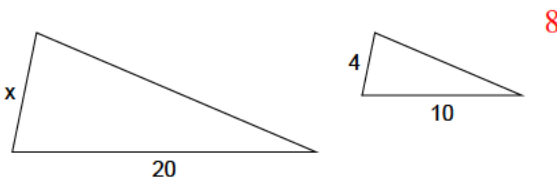
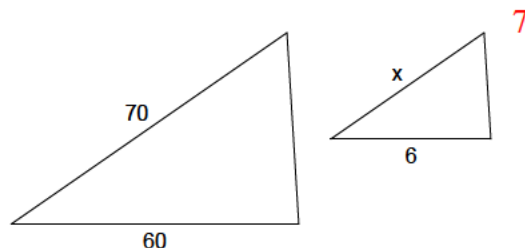
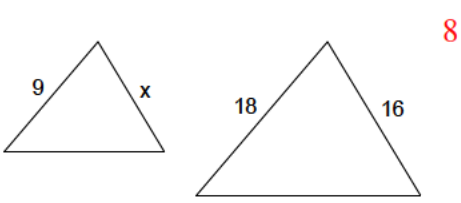
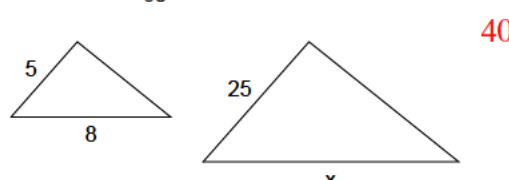
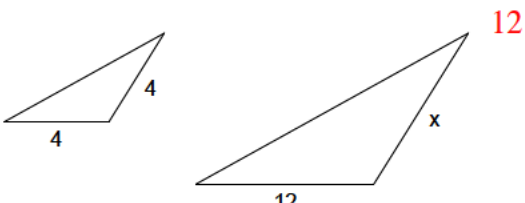
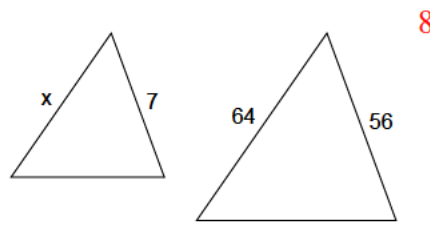
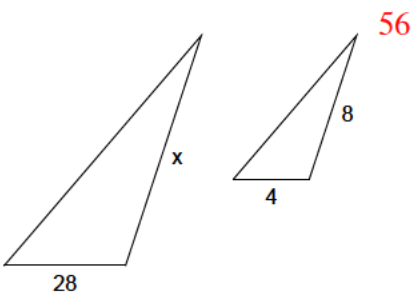
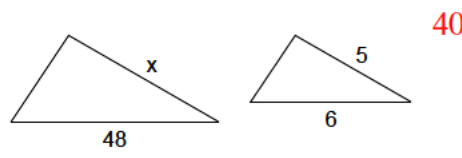
- 47)  12
- 48)  6
- 49)  72
- 50)  25
- 51)  4
- 52)  30
- 53)  9
- 54)  15
- 55)  8
- 56)  7
- 57)  8
- 58)  40
- 59)  12
- 60)  8
- 61)  56
- 62)  40

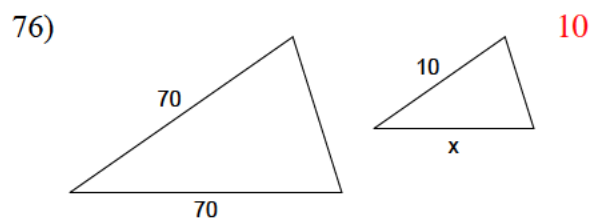
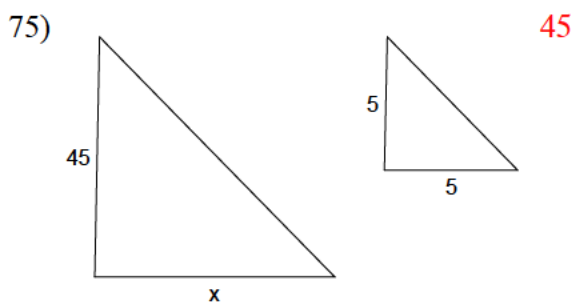
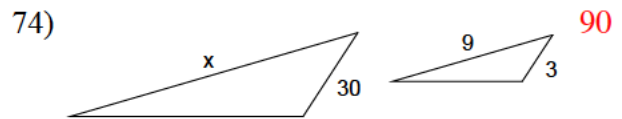
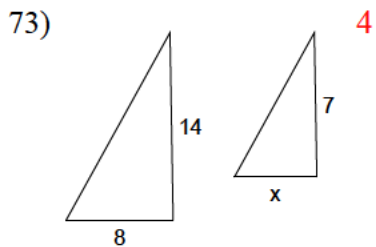
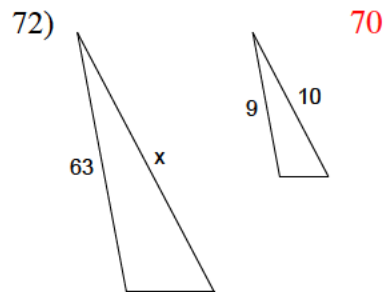
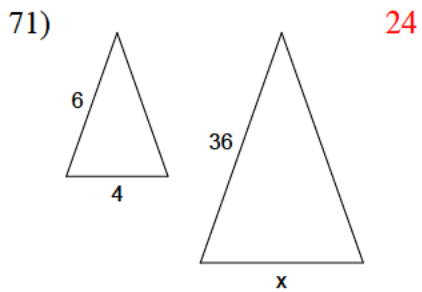
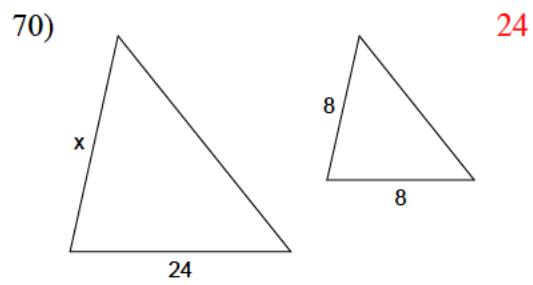
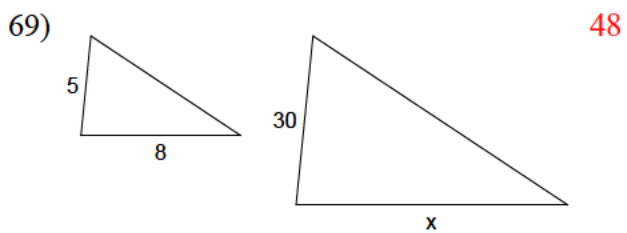
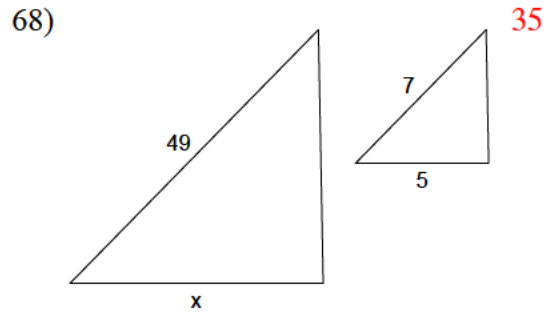
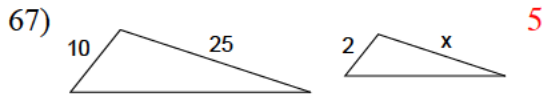
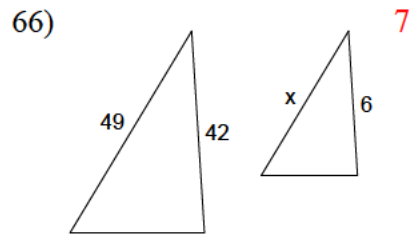
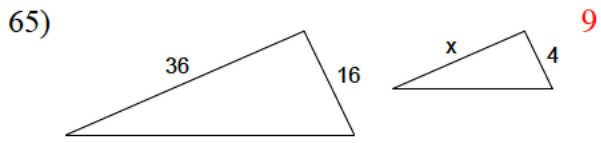
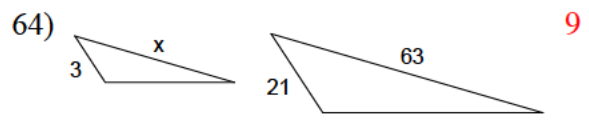
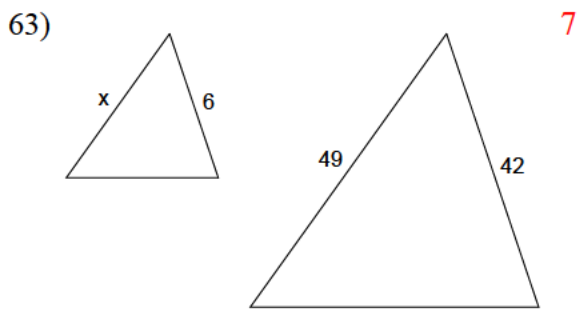

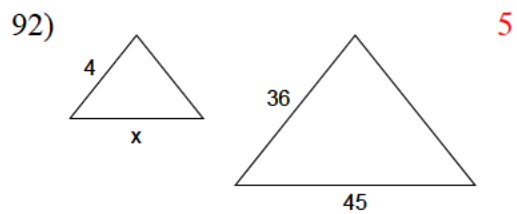
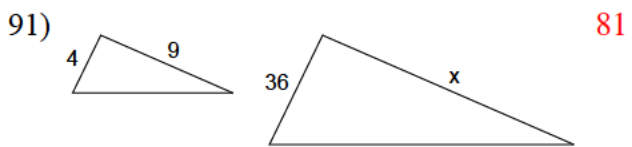
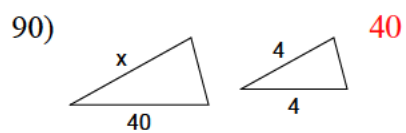
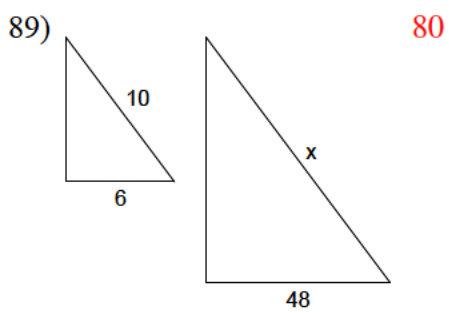
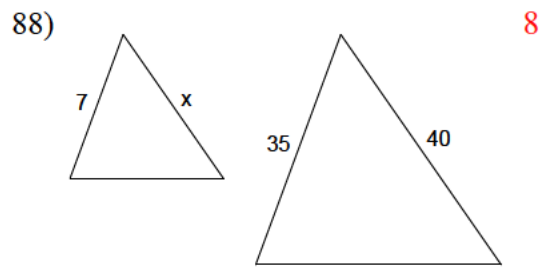
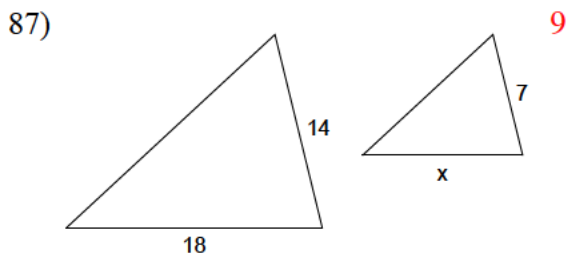
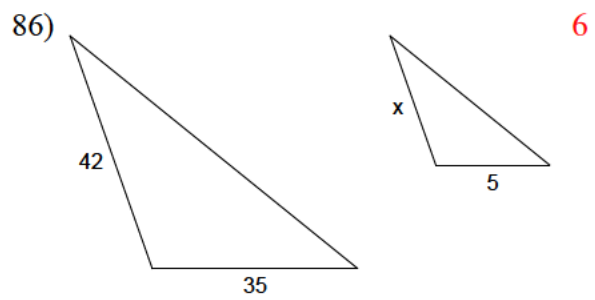
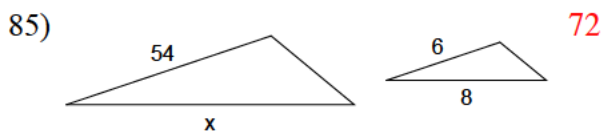
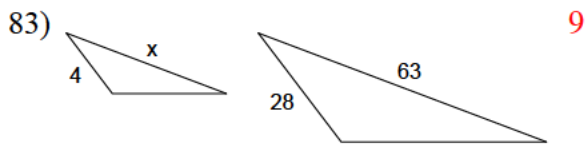
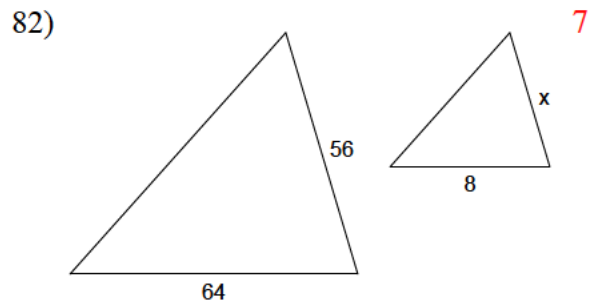
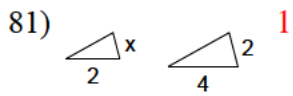
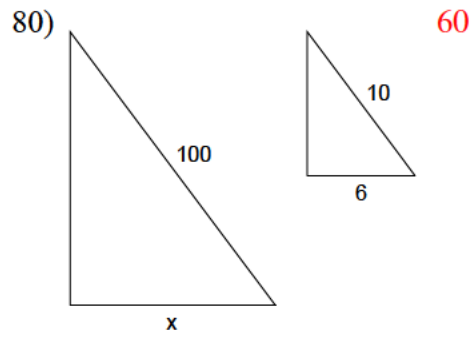
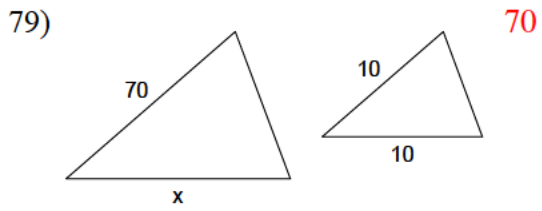
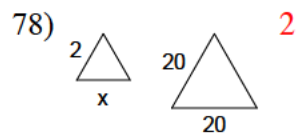
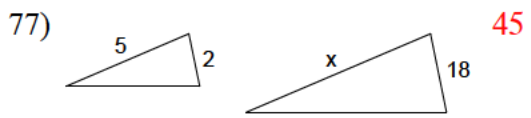

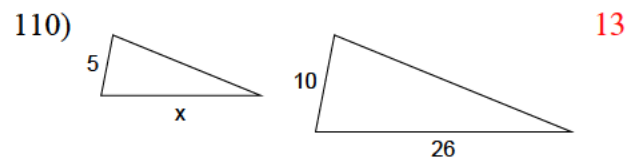
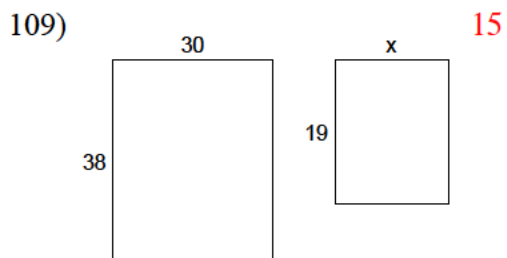
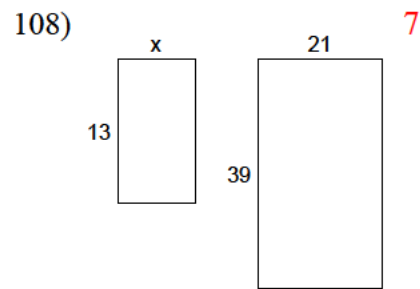
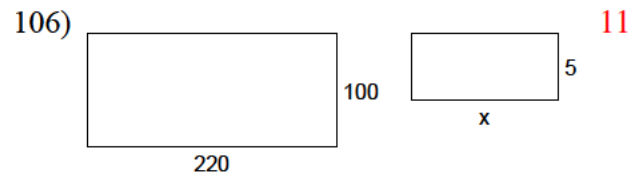
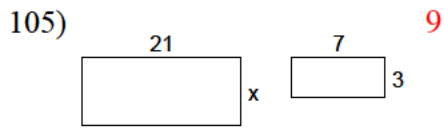
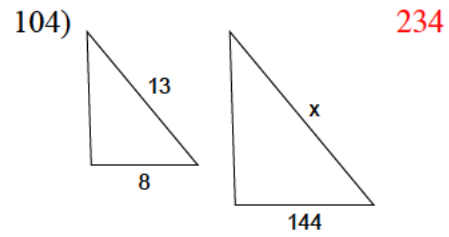
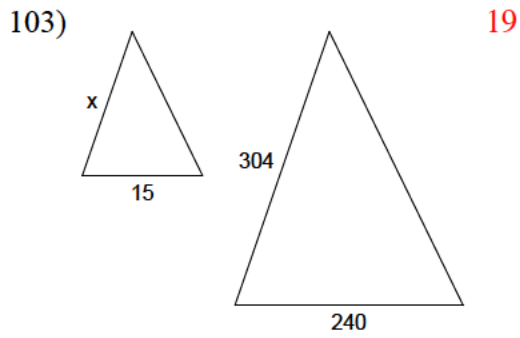
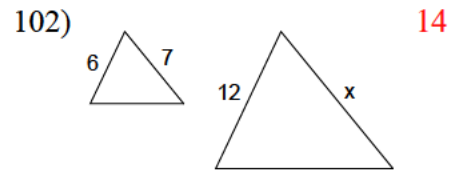
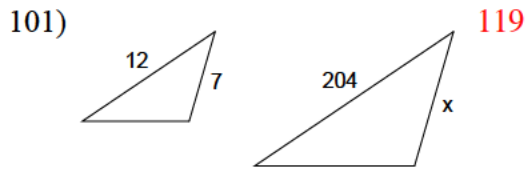
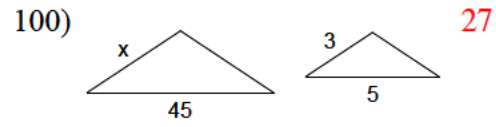
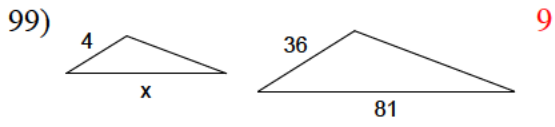
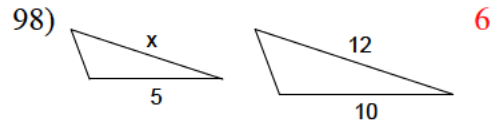
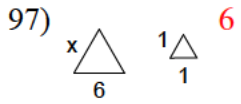
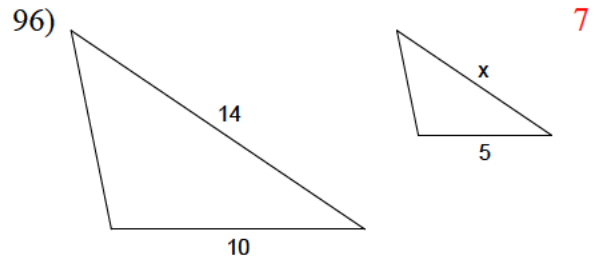
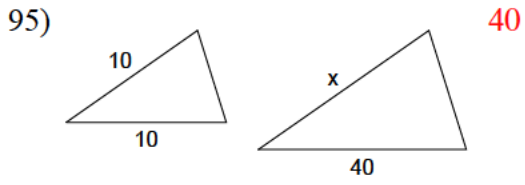
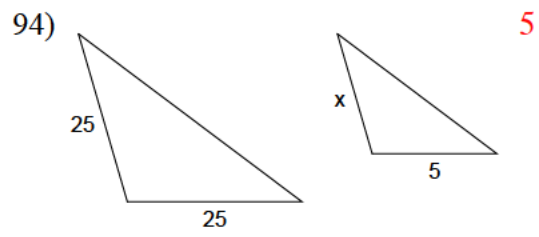
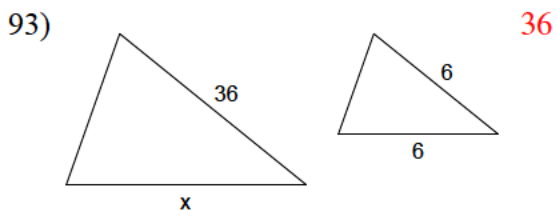

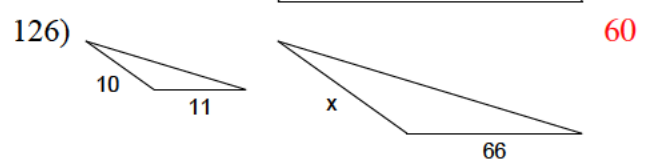
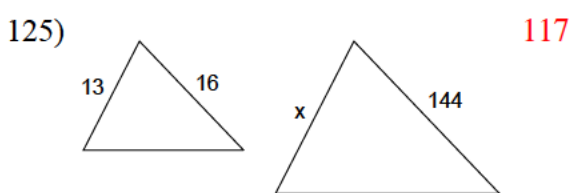
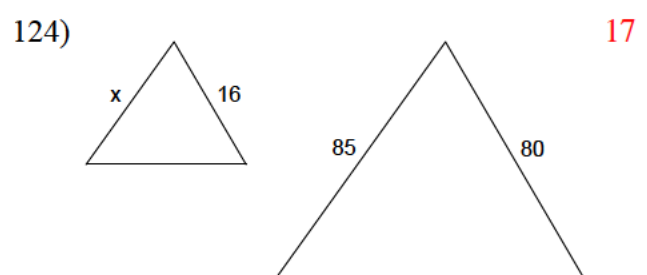
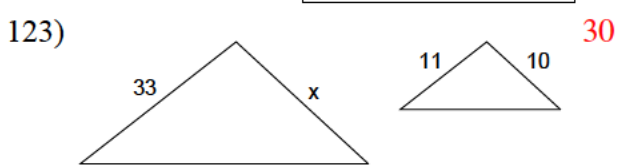
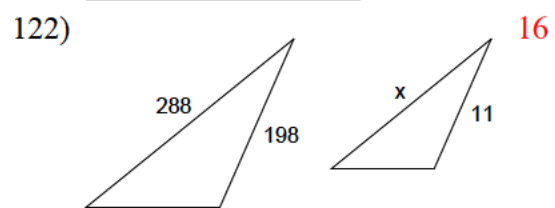
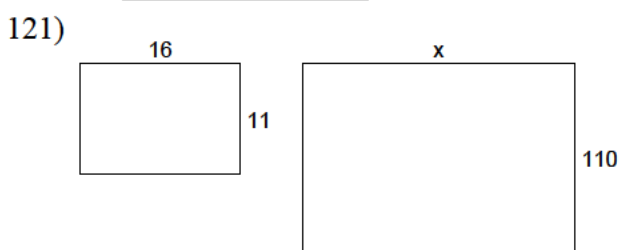
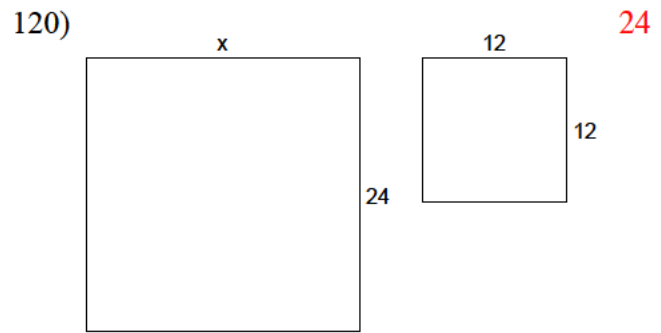
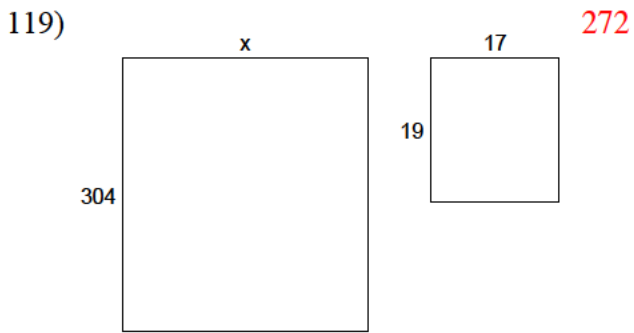
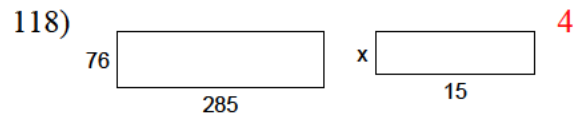
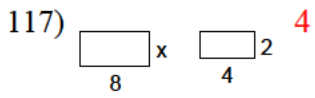
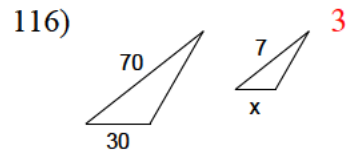
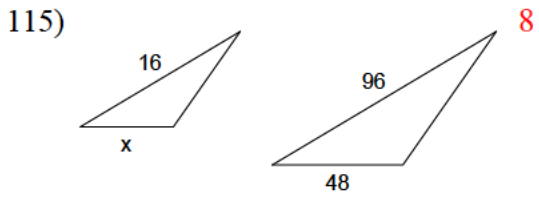
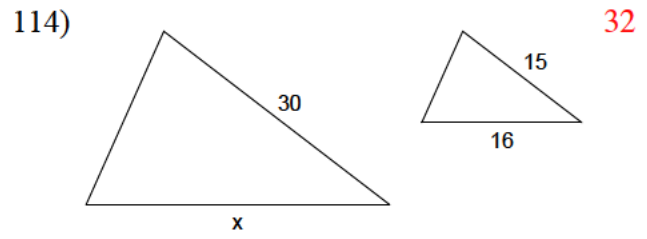
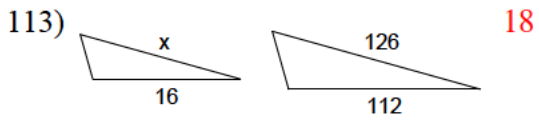
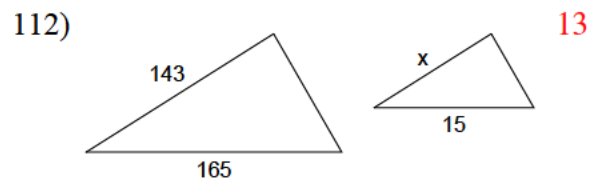
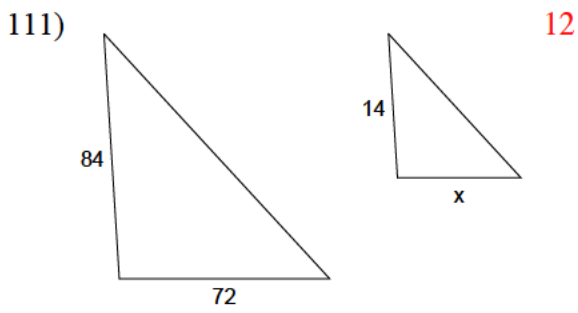

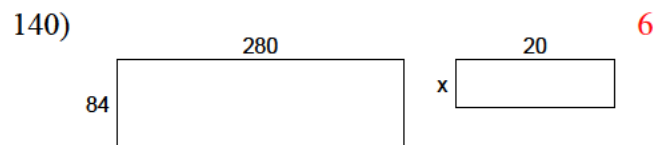
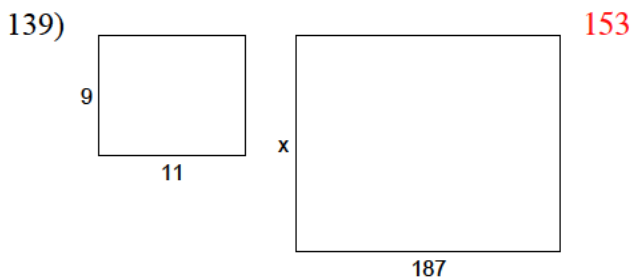
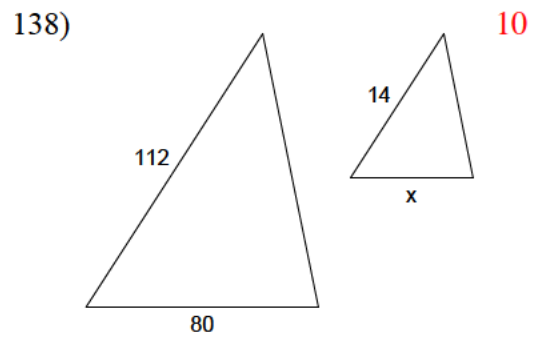
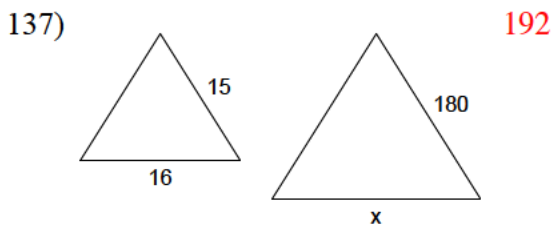
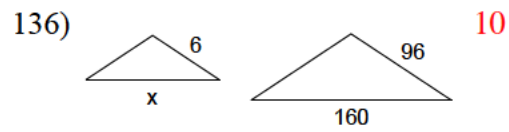
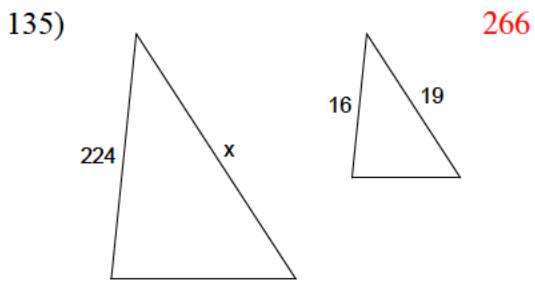
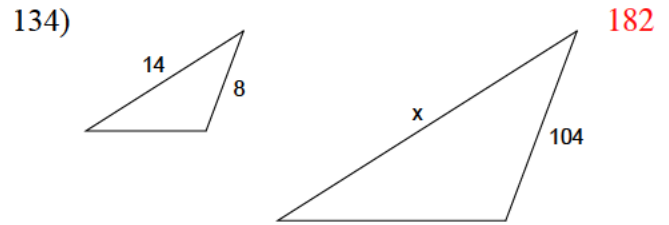
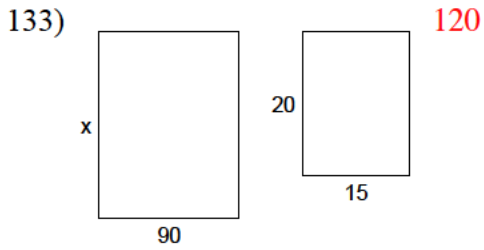
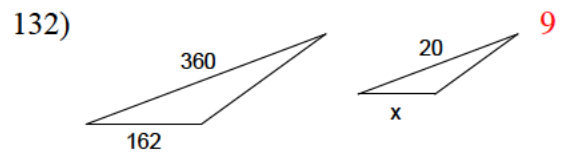
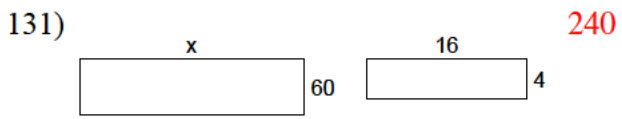
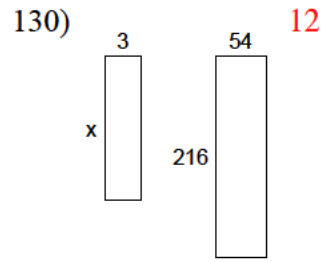
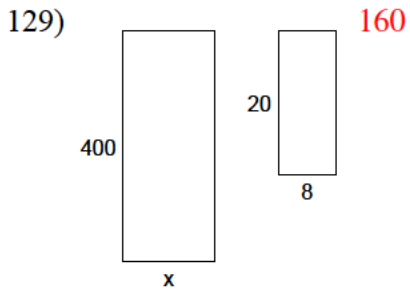
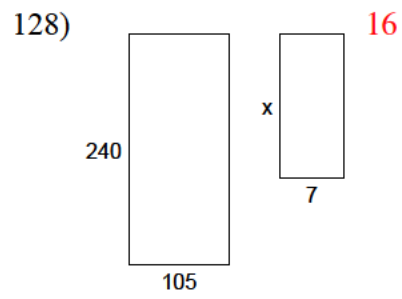
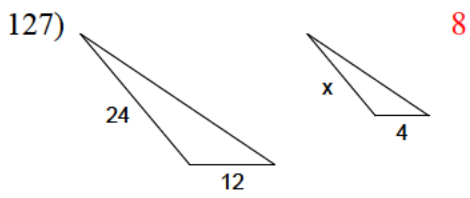

141) 228

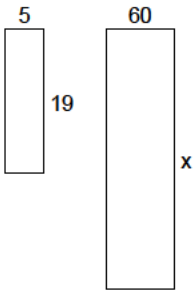

142) 256

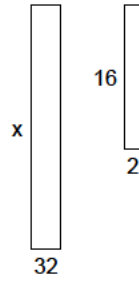

143) 140

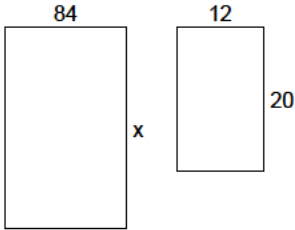

144) 168

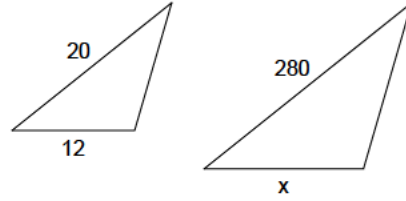

145) 19

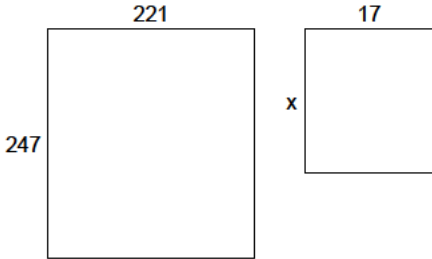

146) 108

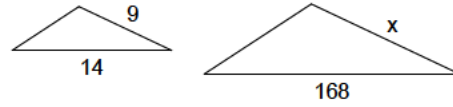

147) 19

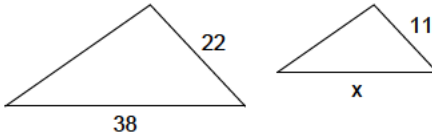

148) 2

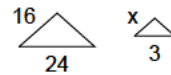

149) 20

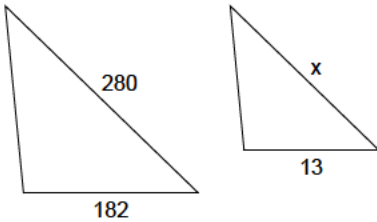

150) 18

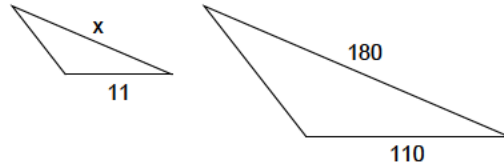

151) 208

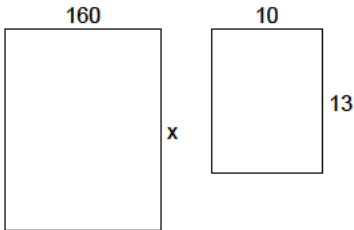

152) 17

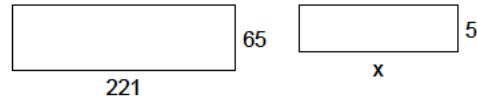

153) 198

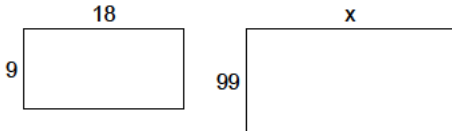

154) 13

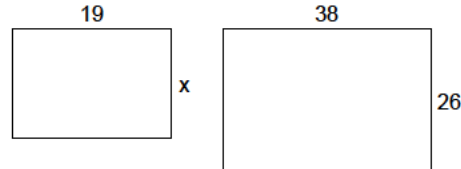

155) 6

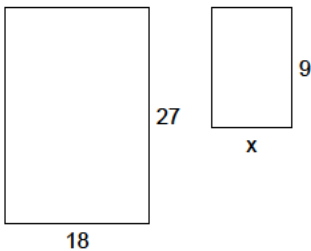

156) 10

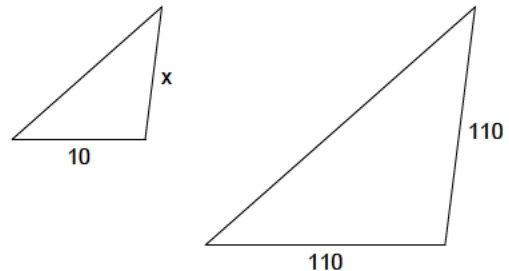

157) 216

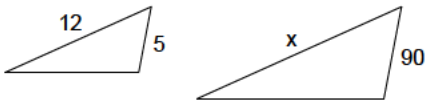

158) 30

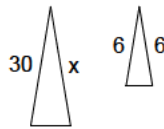

159) 50

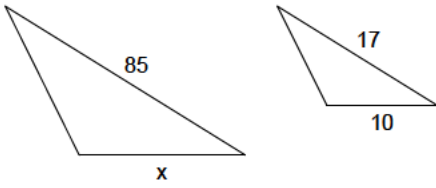

160) 160

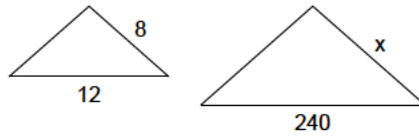

161) 5

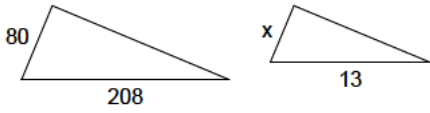

162) 8

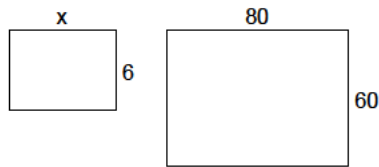

163) 2

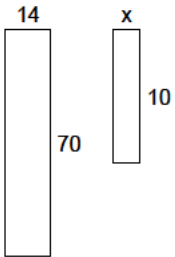

164) 24

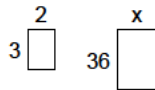

165) 6

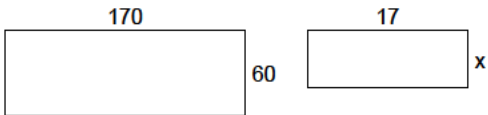

166) 70

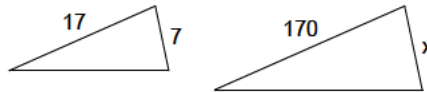

167) 143

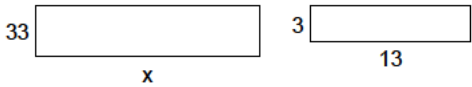

168) 70

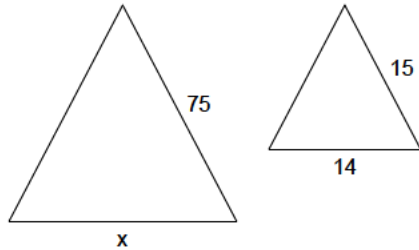

169) 288



170) 33

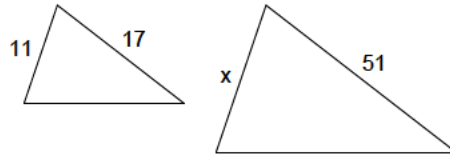

171) 112

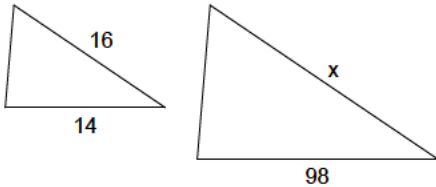

172) 7

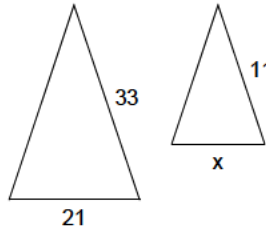

173) 72

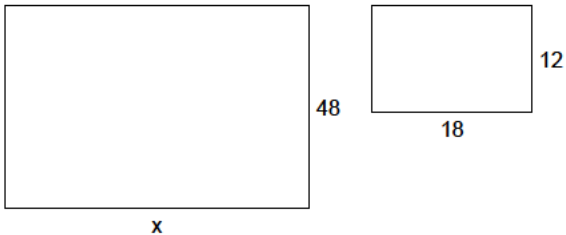

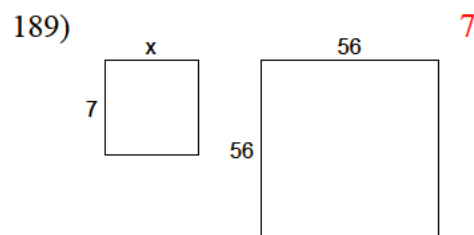
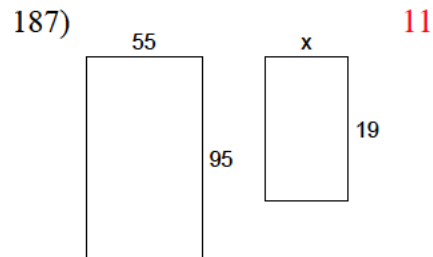
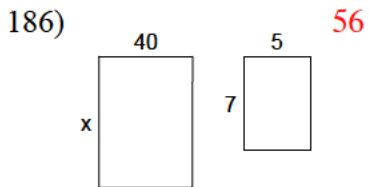
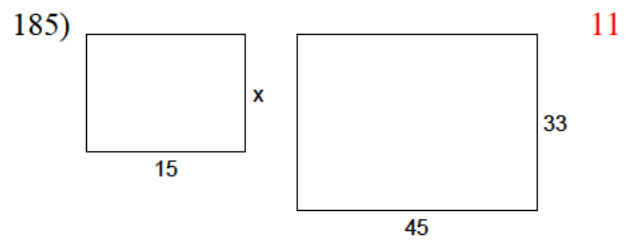
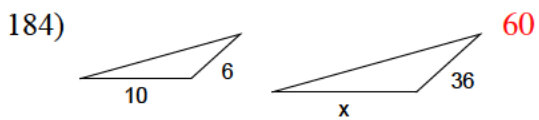
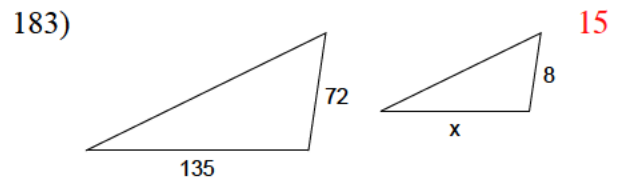
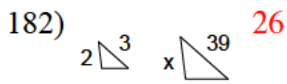
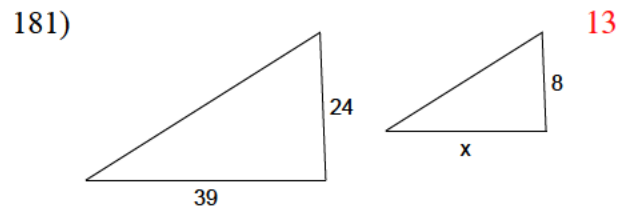
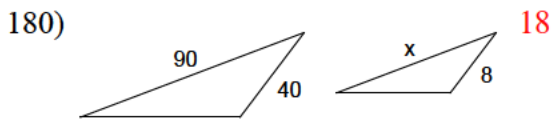
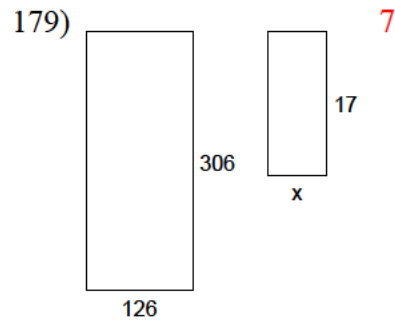
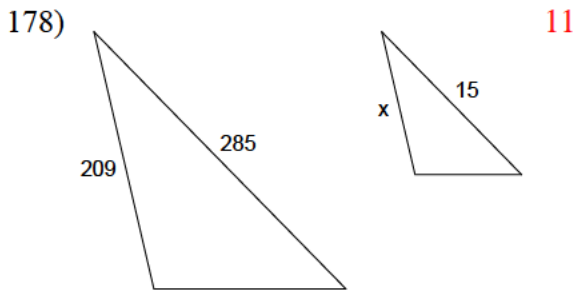
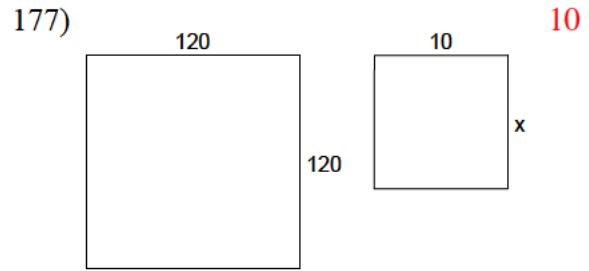
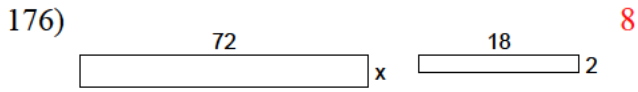
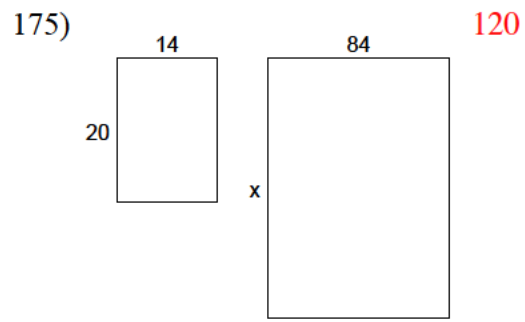
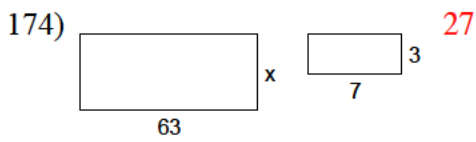

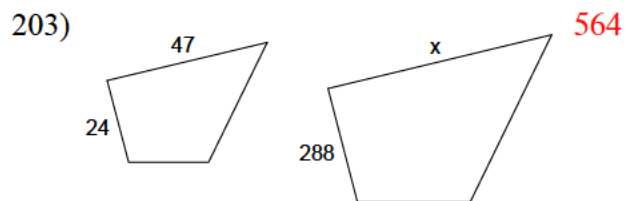
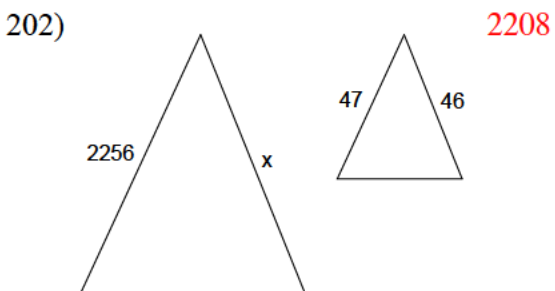
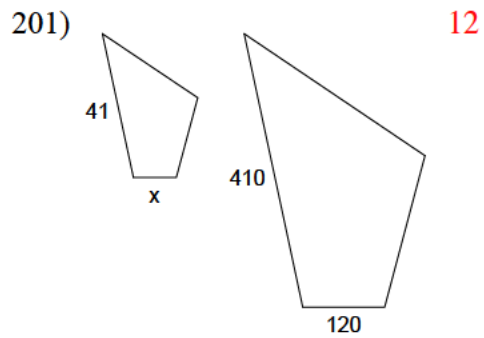
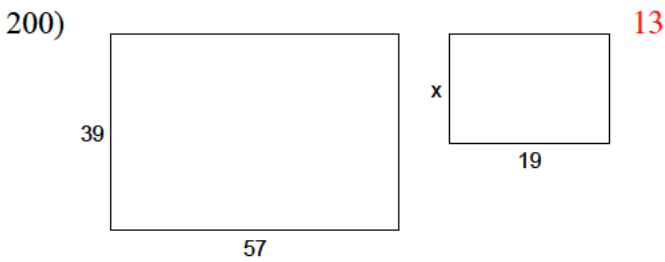
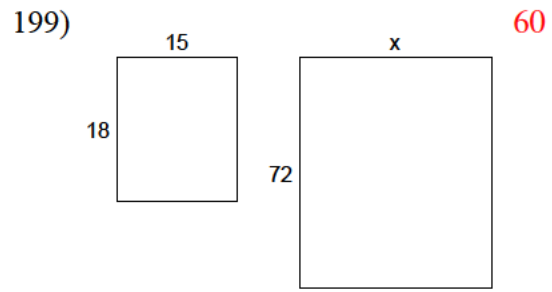
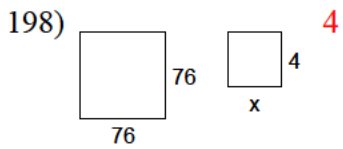
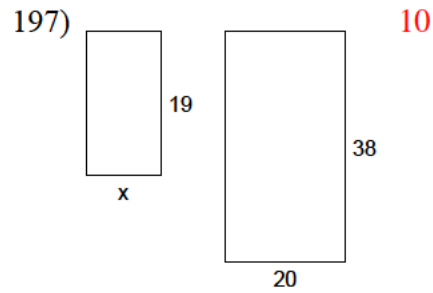
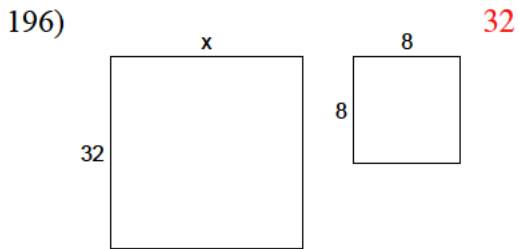
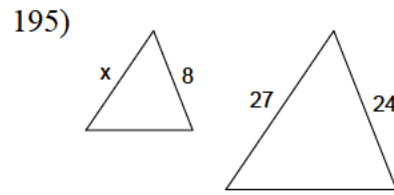
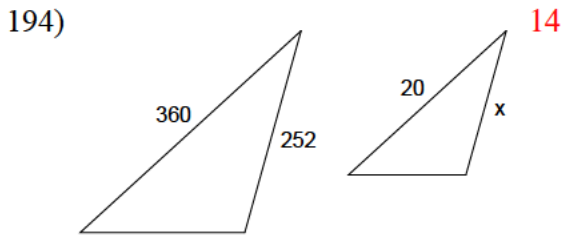
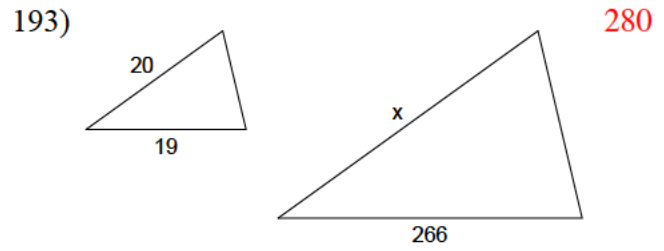
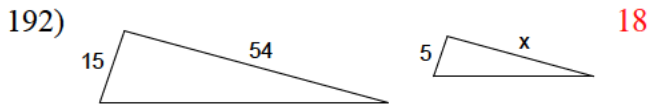
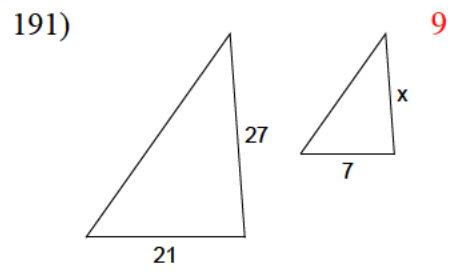
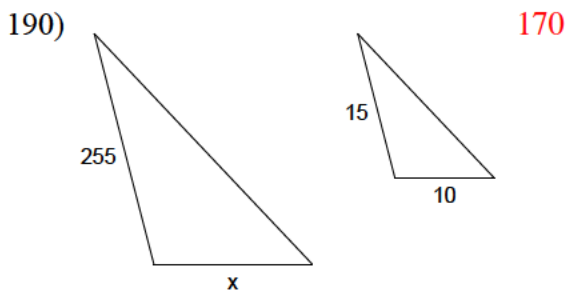

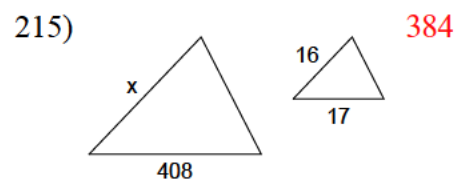
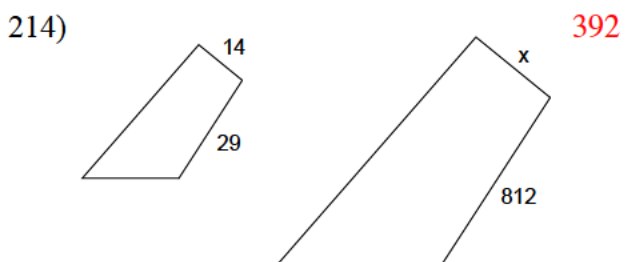
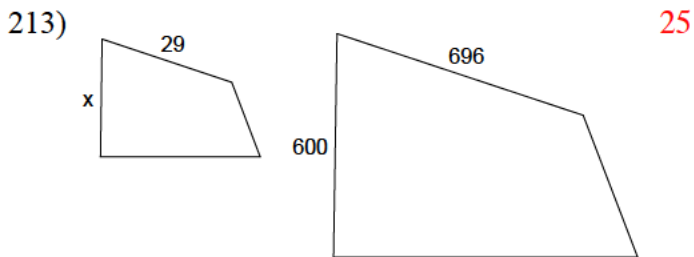
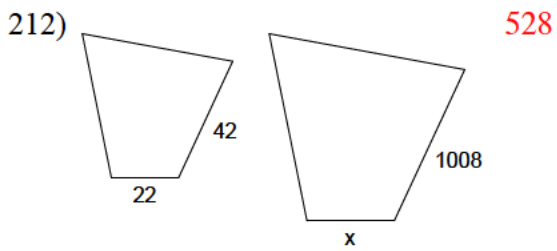
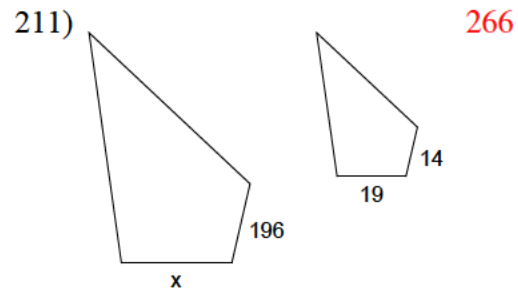
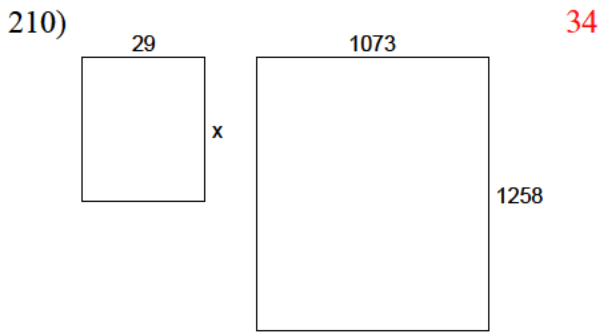
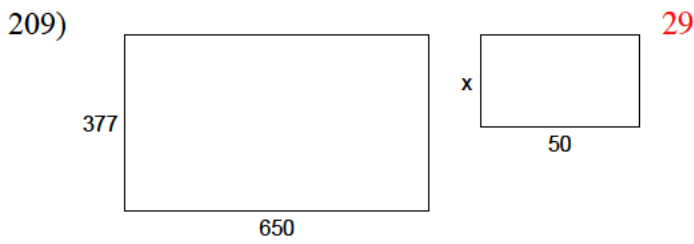
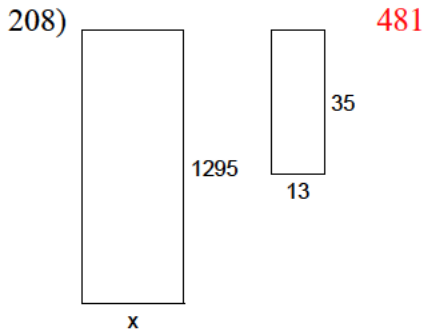
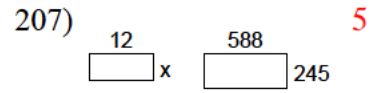
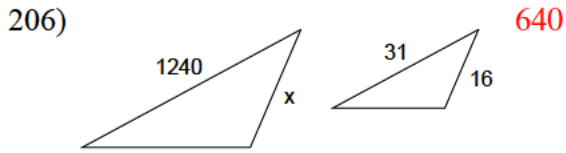
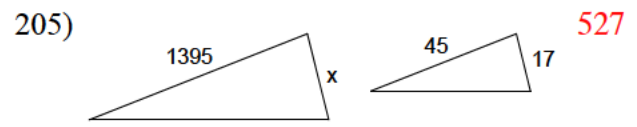
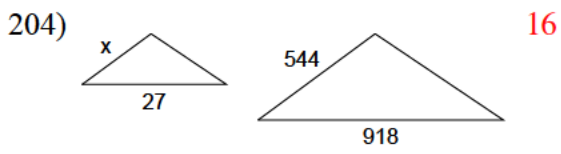

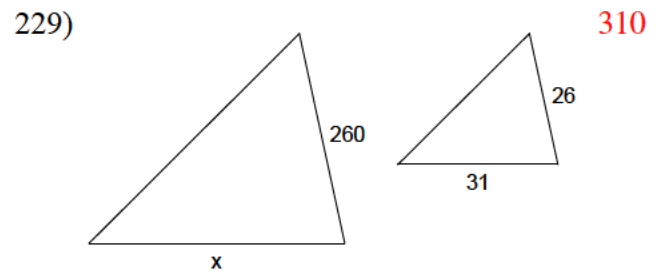
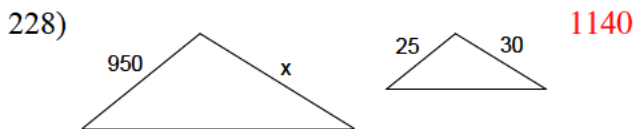
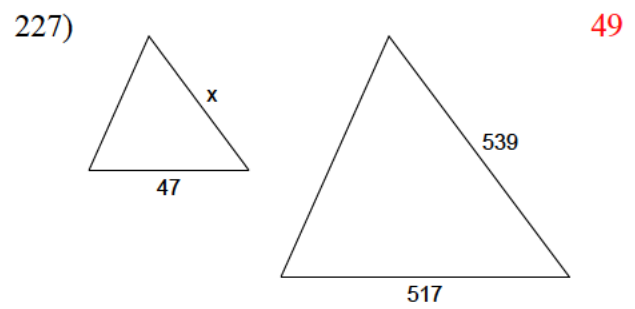
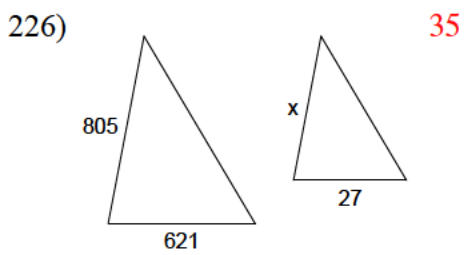
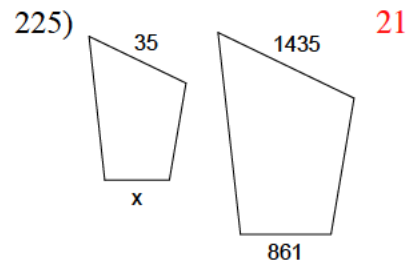
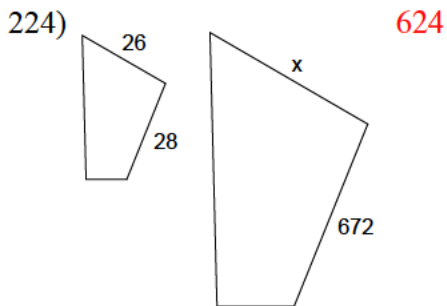
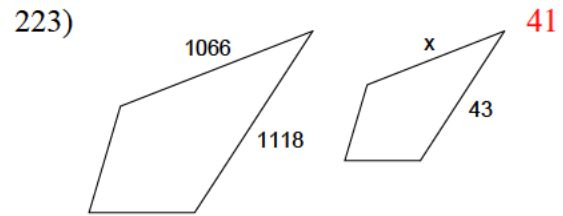
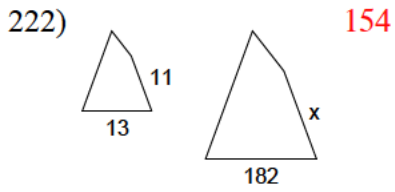
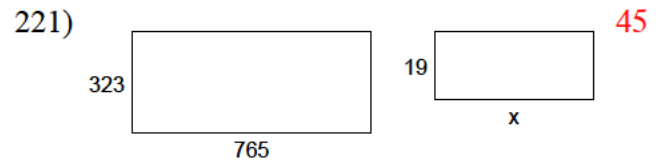
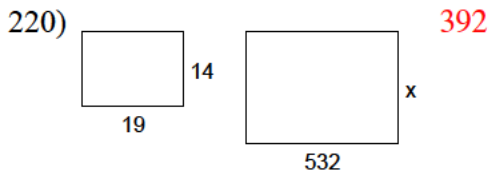
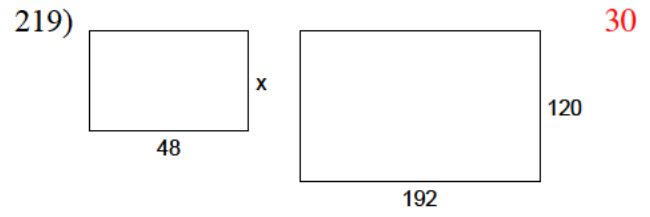
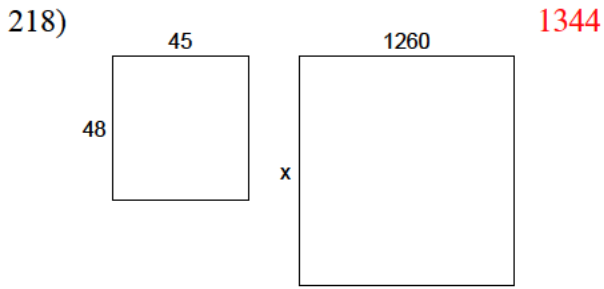
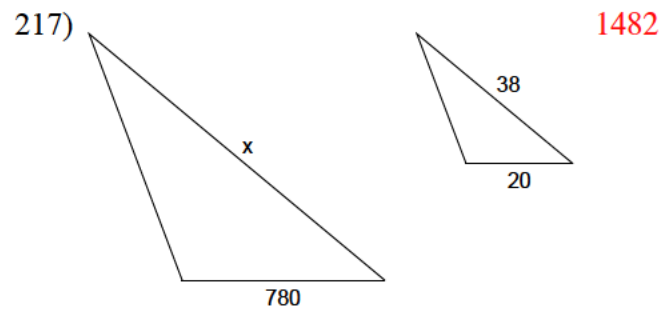
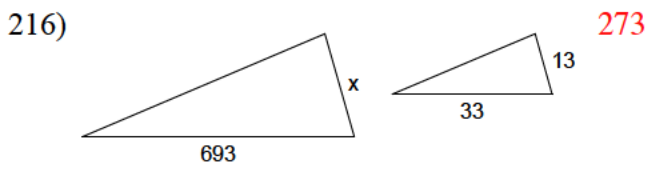

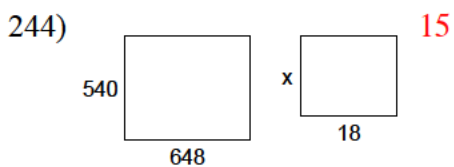
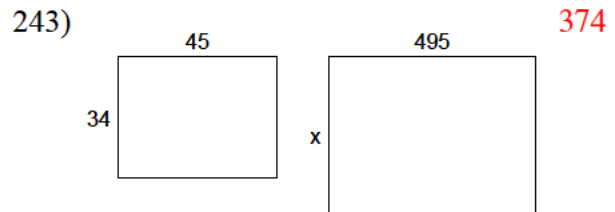
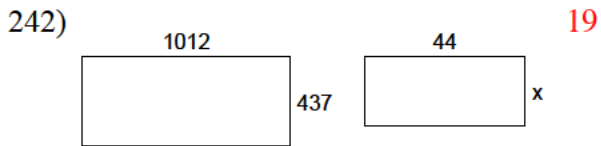
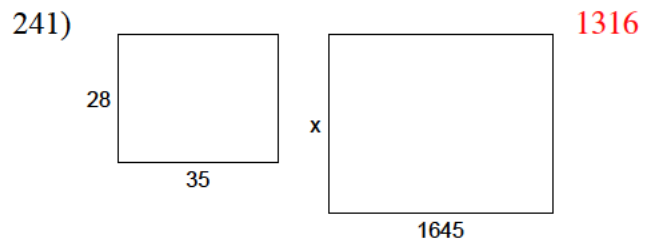
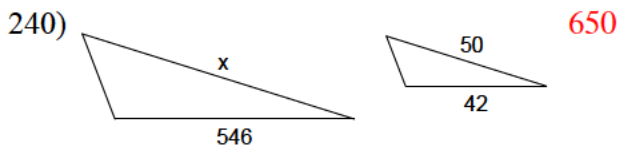
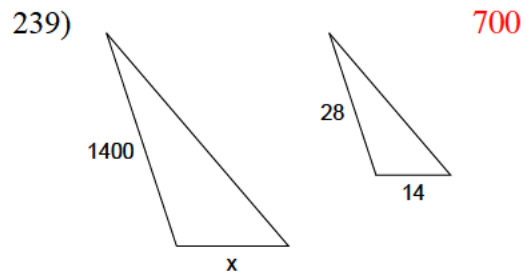
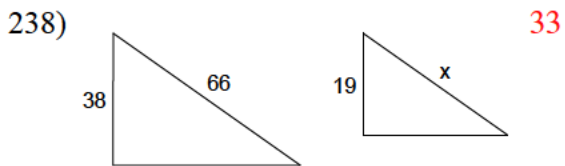
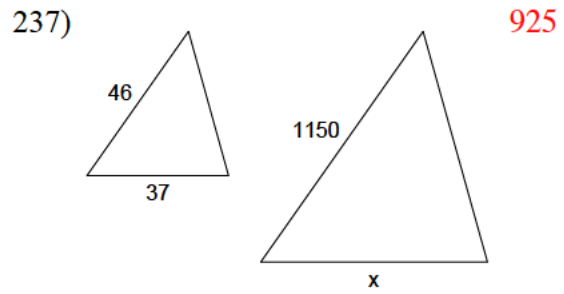
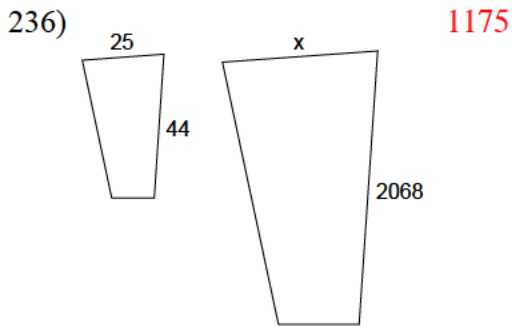
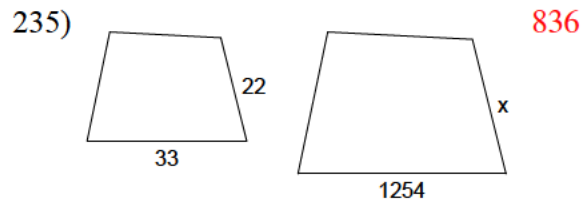
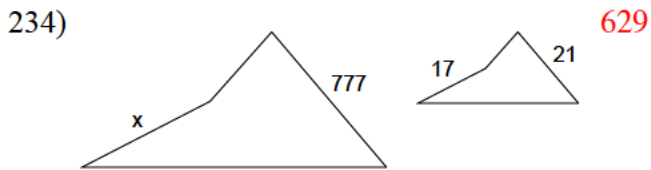
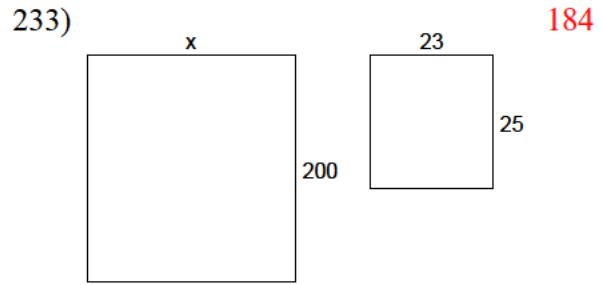
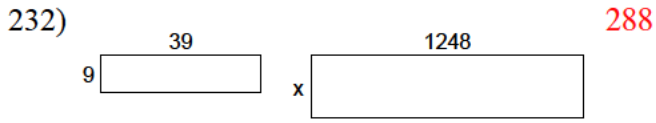
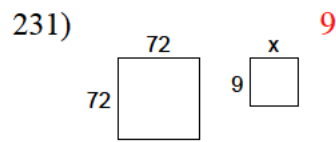
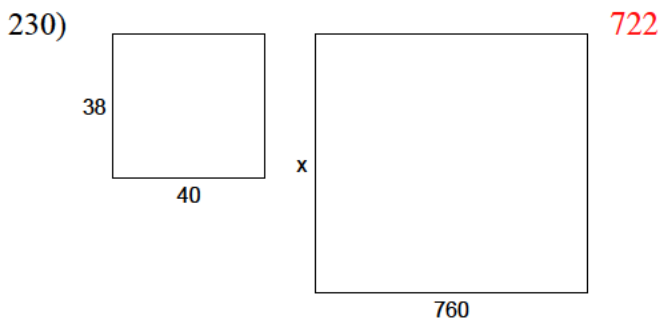

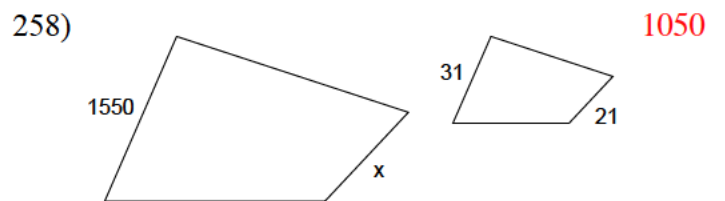
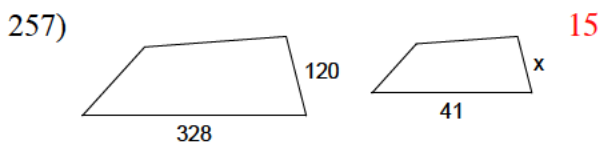
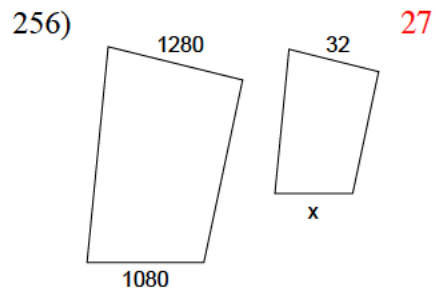
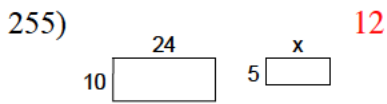
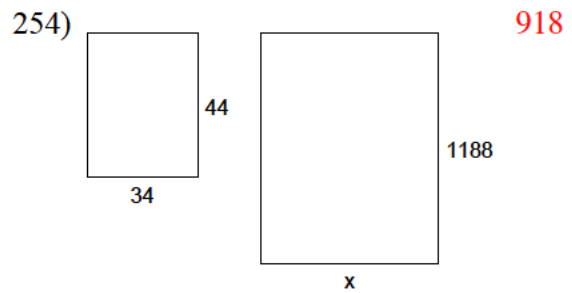
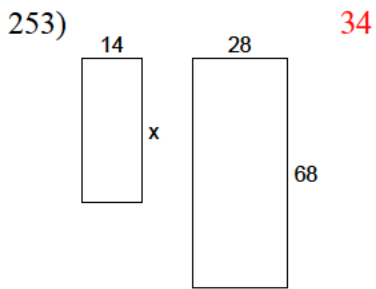
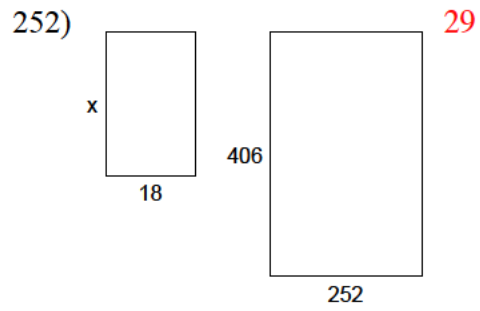
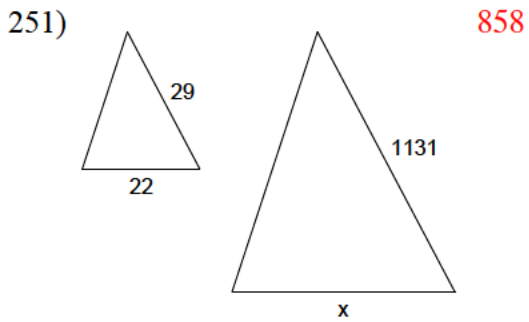
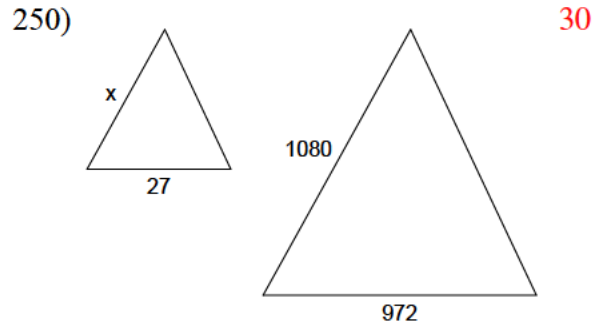
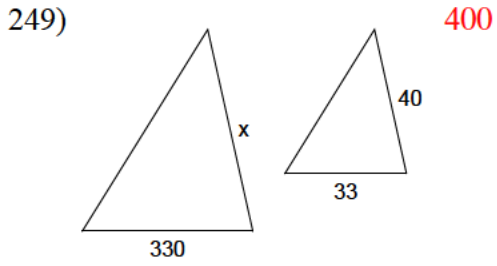
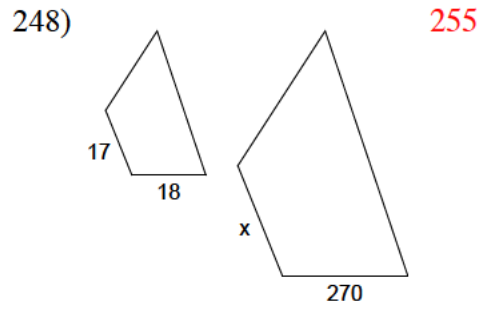
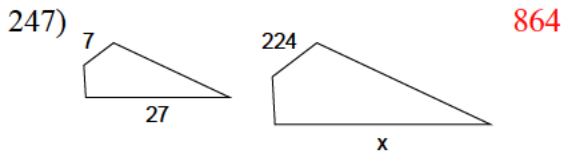
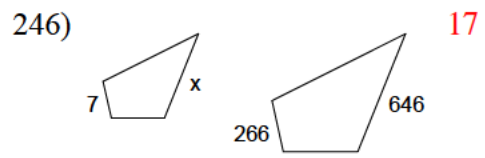
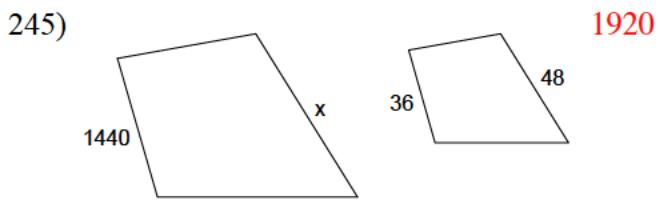

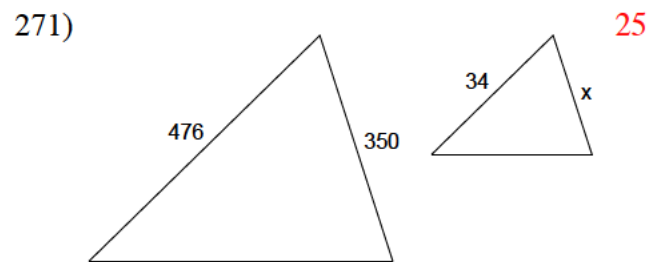
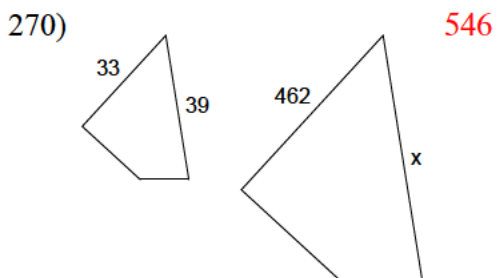
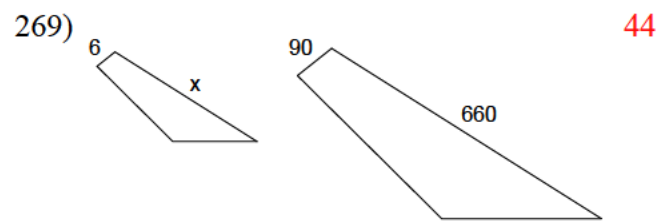
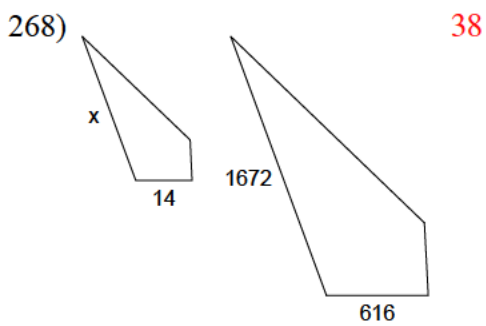
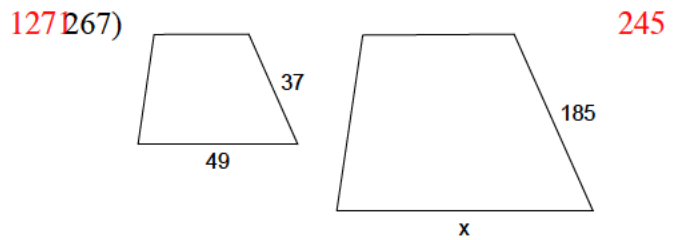
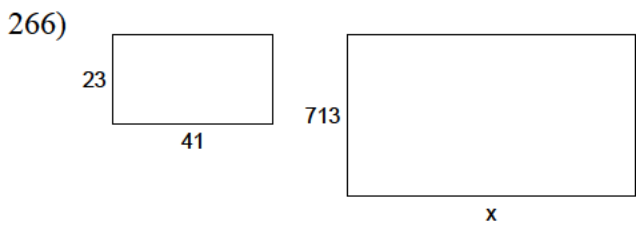
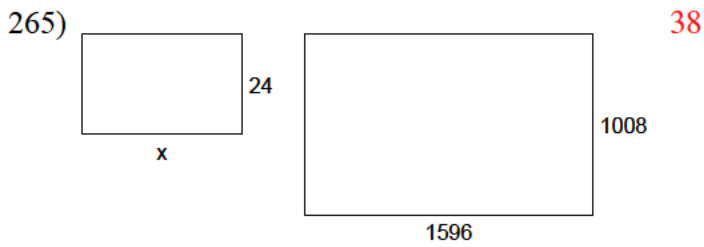
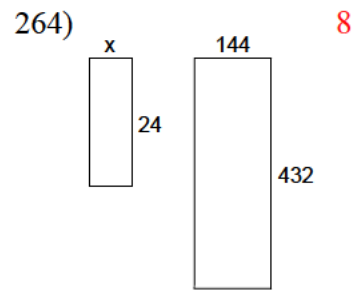
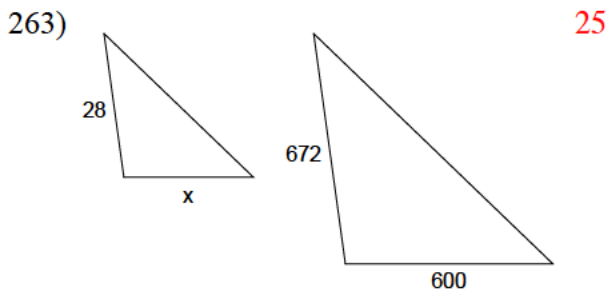
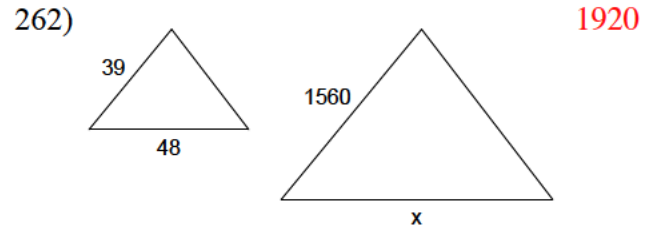
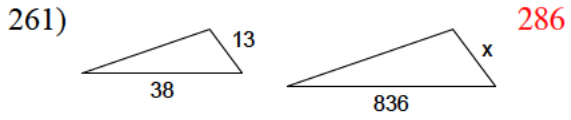
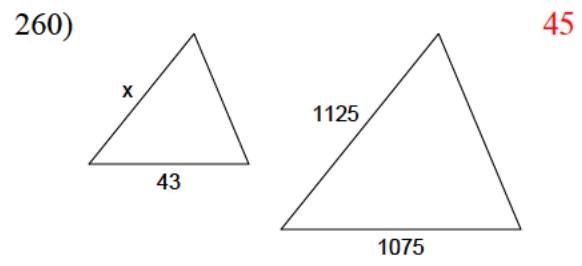
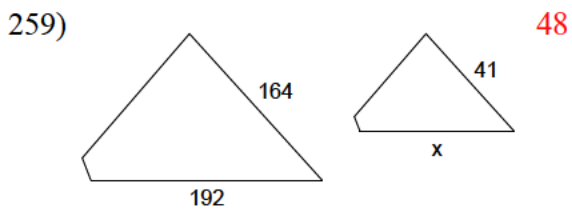

272) 250

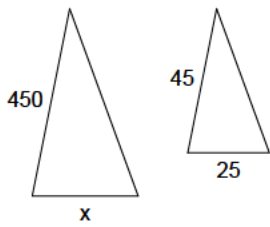

273) 8

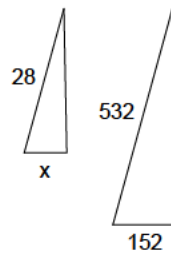

274) 33

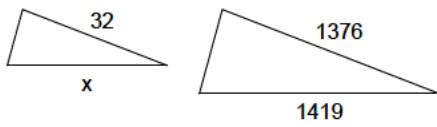

275) 644

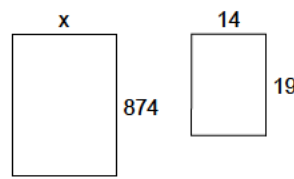

276) 294

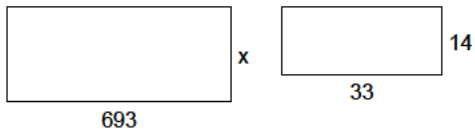

277) 17

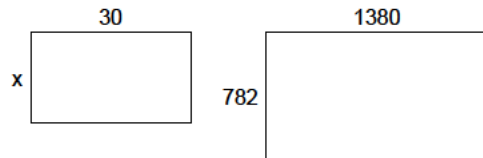

278) 1680

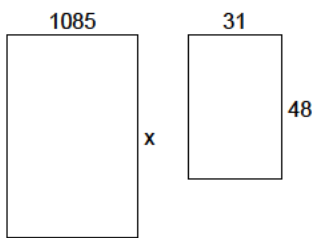

279) 35

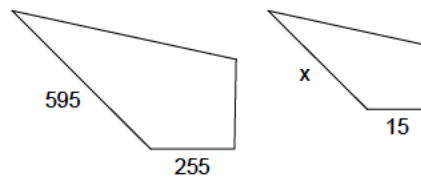

280) 9

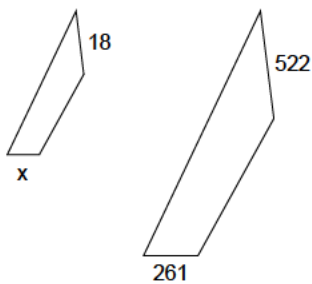

281) 47

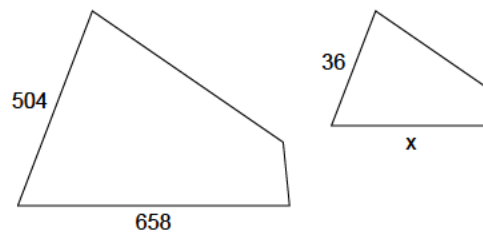

282) 253

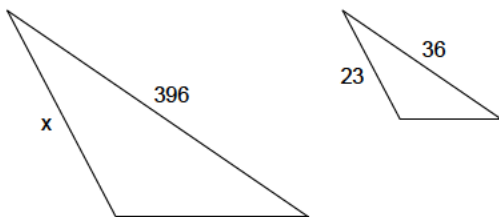

283) 960

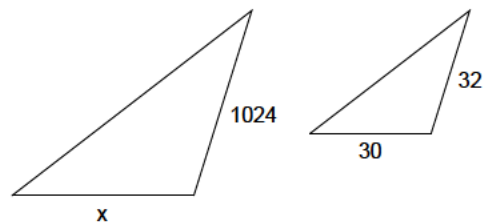

284) 43

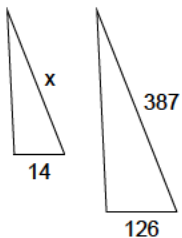

285) 986

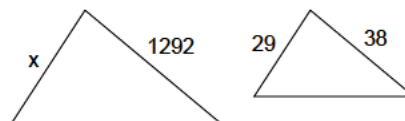

286) 156

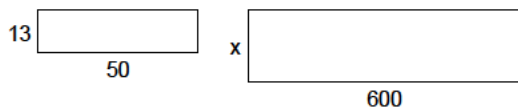

287) 43

