

Find the volume of prism, pyramid, cylinder, cone or sphere

Find the volume of each prism:

1)

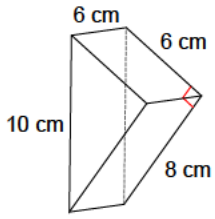

2)

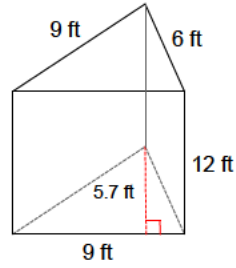

3)

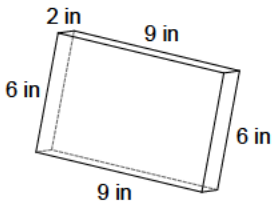

4)

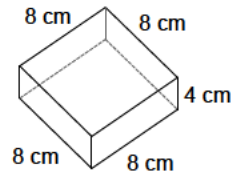

5)

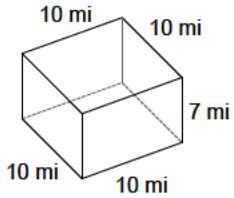

6)

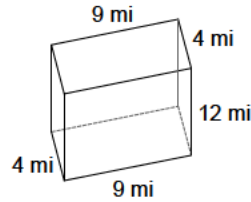

7)

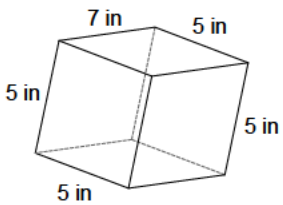

8)

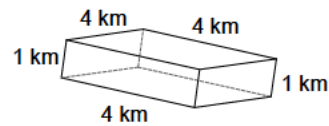

9)

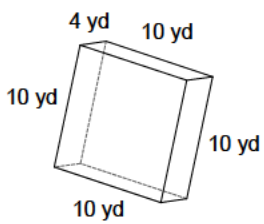

10)

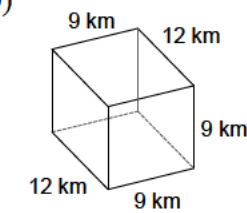

11)

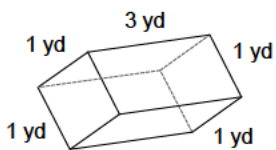

12)

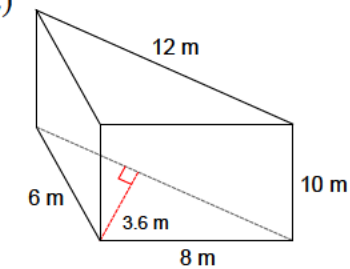

13)

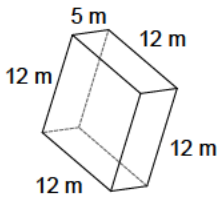

14)

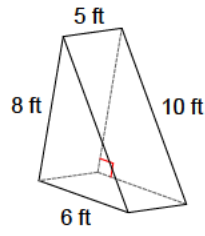

15)

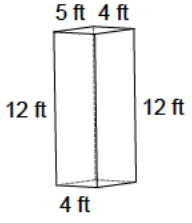

16)

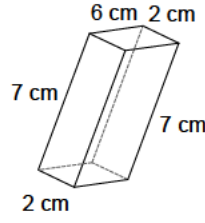

17)

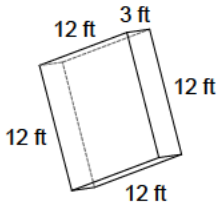

18)

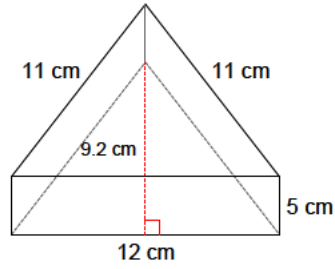

19)

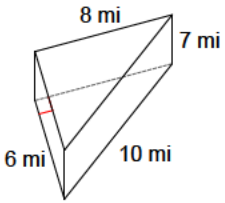

20)

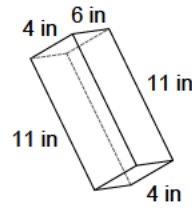

21)

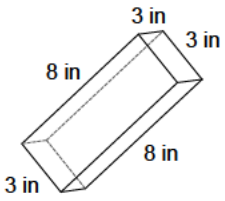

22)

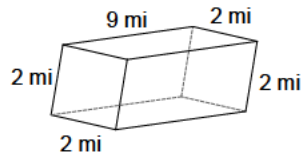

23)

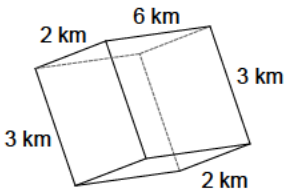

24)

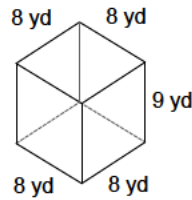

25)

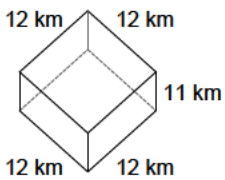

26)

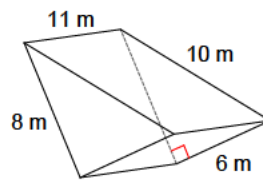

27)

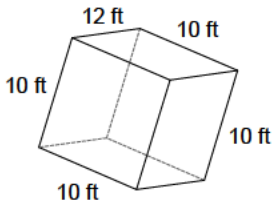

28)

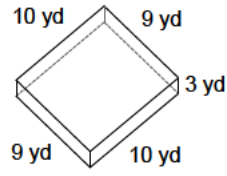

29)

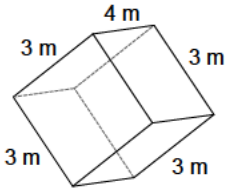

30)

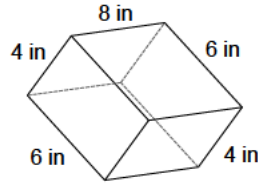

31)

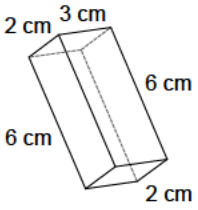

32)

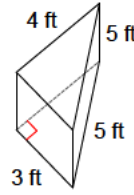

33)

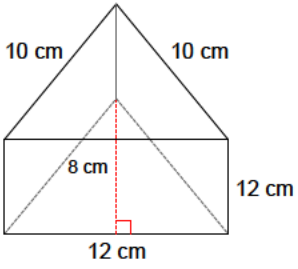

34)

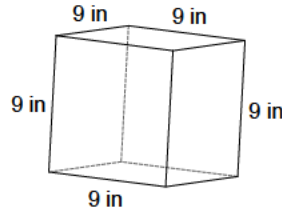

35)

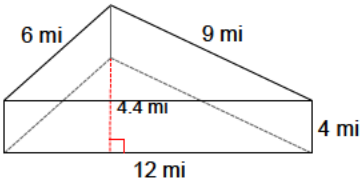

36)

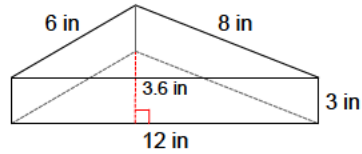

37)

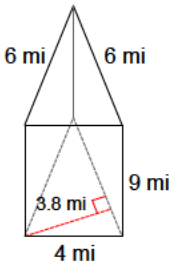

38)

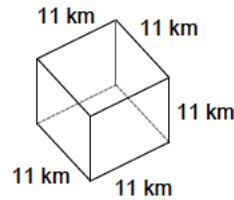

39)

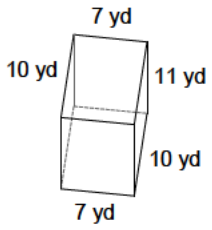

40)

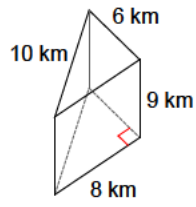

41)

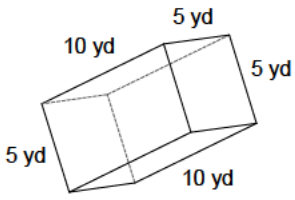

42)

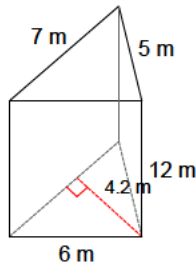

43)

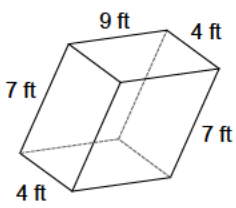

44)

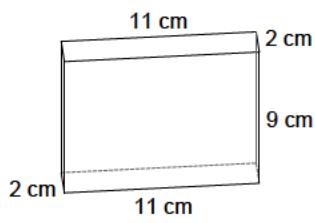

45)

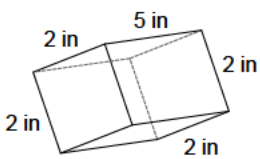

46)

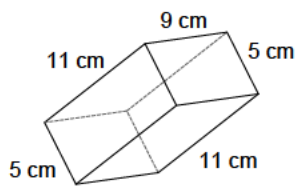

47)

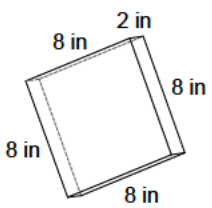

48)

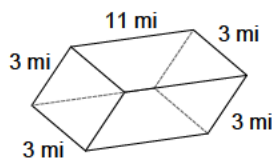

49)

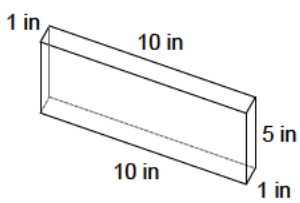

50)

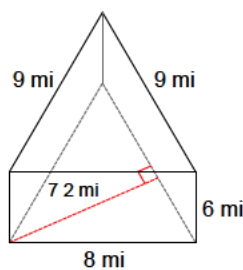

51)

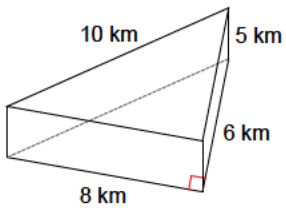

52)

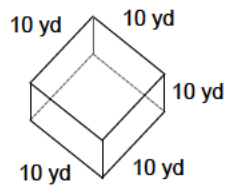

53)

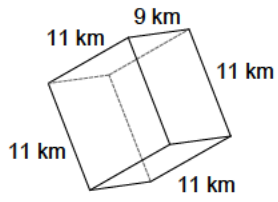

54)

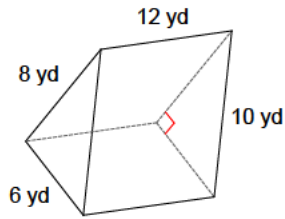

55)

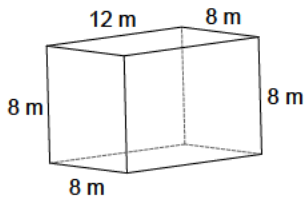

56)

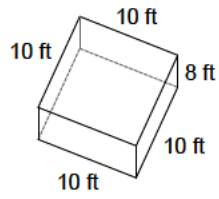

57)

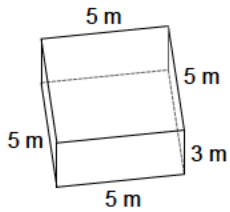

58)

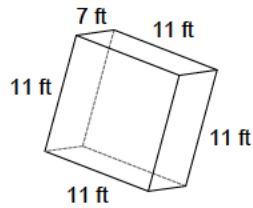

59)

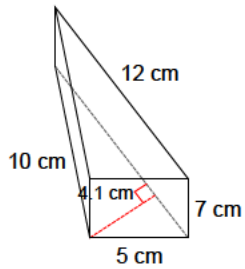

60)

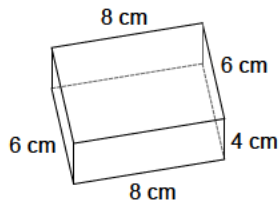

61)

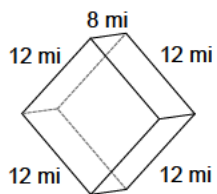

62)

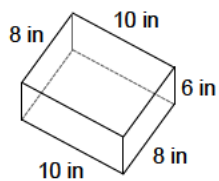

63)

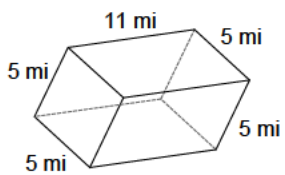

64)

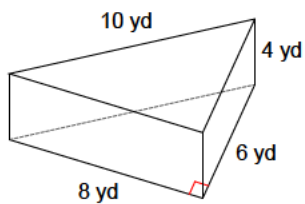

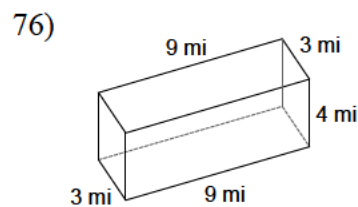
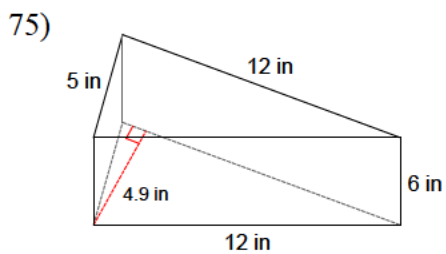
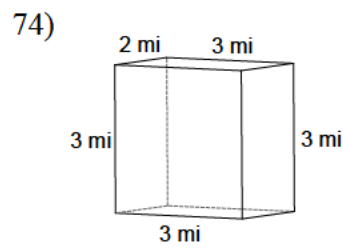
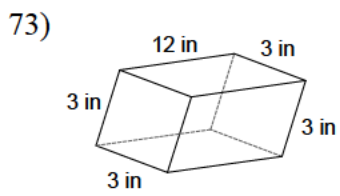
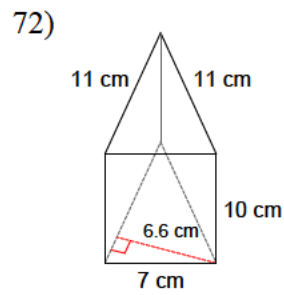
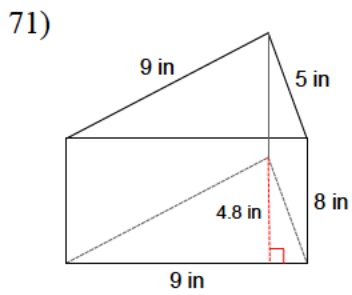
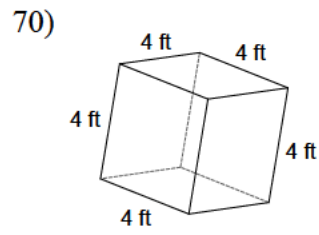
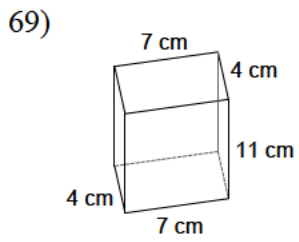
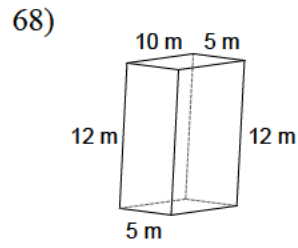
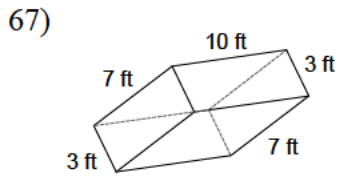
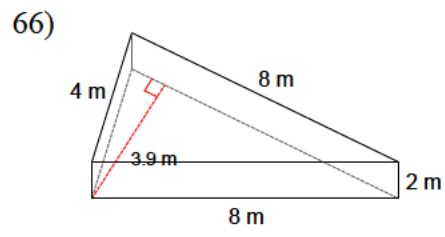
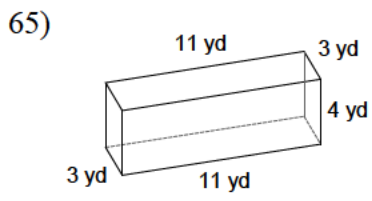

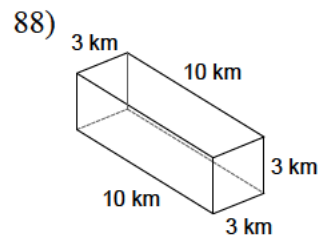
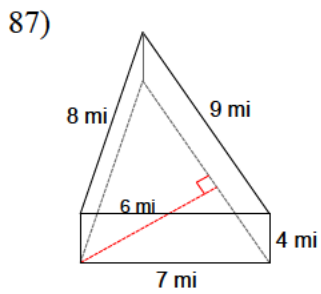
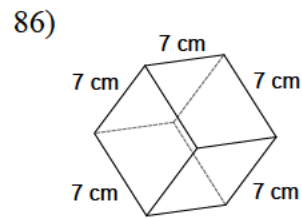
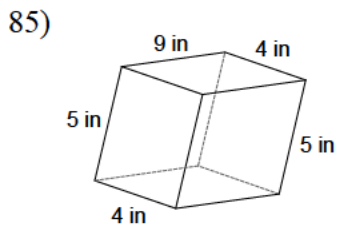
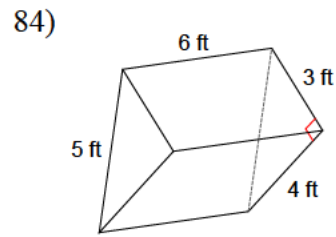
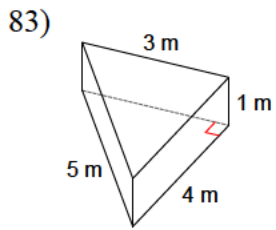
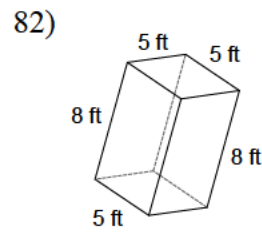
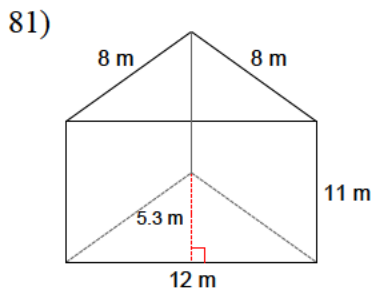
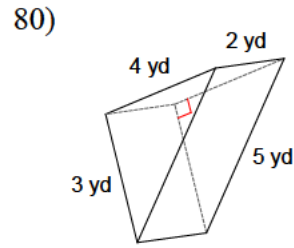
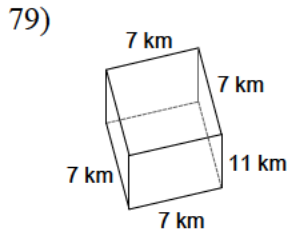
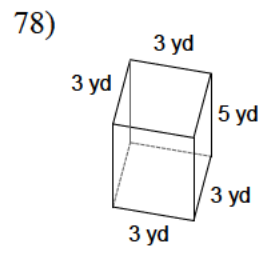
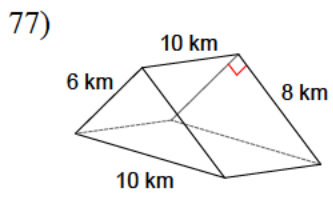

89)

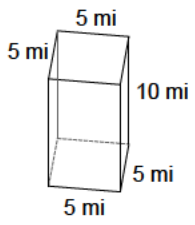

90)

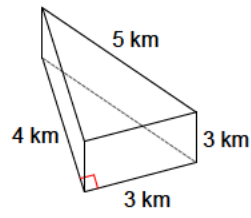

91)

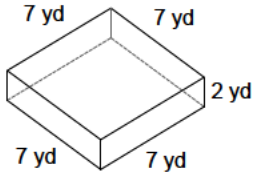

92)

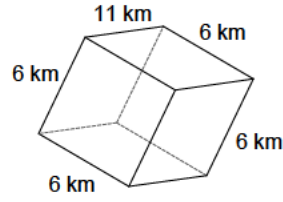

93)

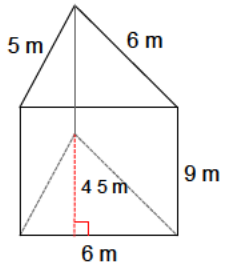

94)

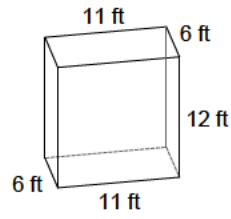

95)

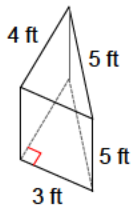

96)

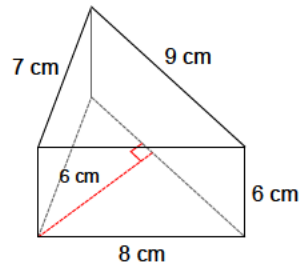

97)

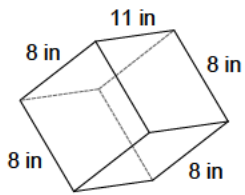

98)

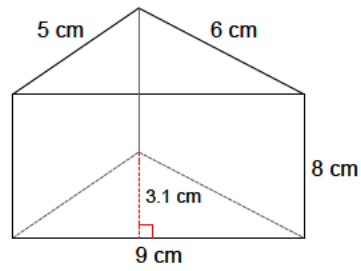

99)

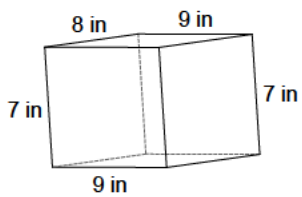

100)

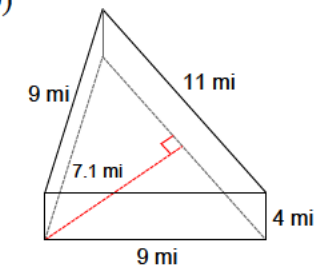

101)

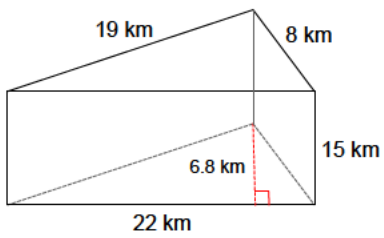

102)

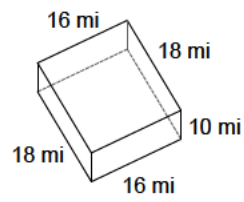

103)

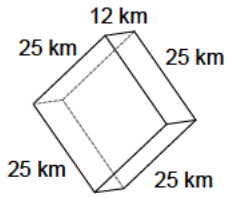

104)

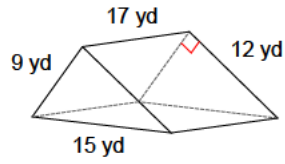

105)

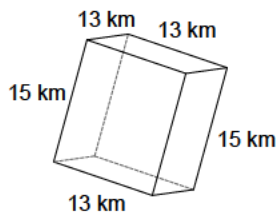

106)

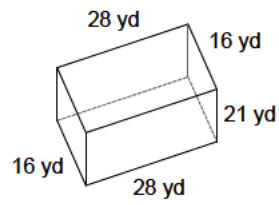

107)

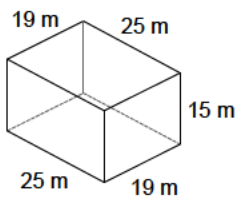

108)

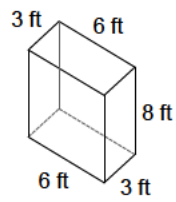

109)

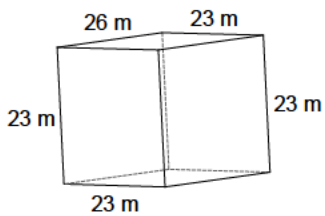

110)

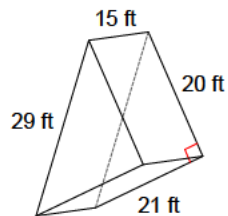

111)

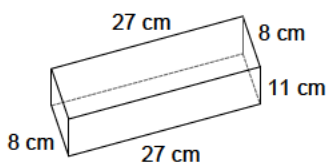

112)

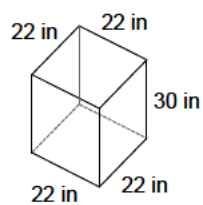

113)

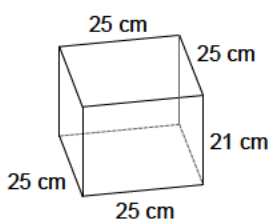

114)

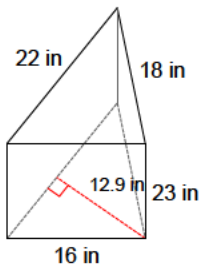

115)

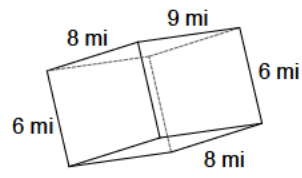

116)

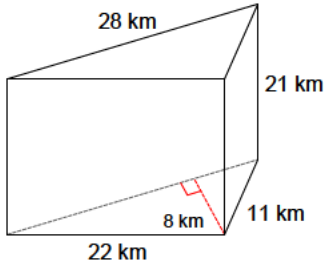

117)

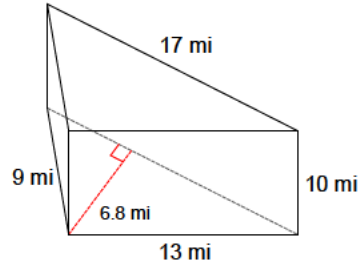

118)

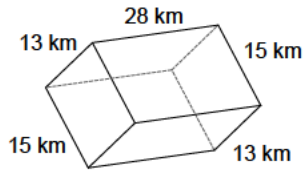

119)

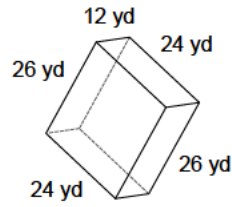

120)

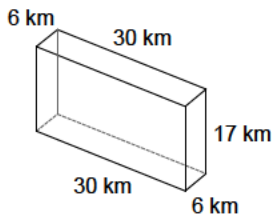

121)

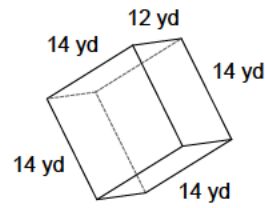

122)

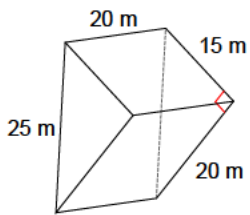

123)

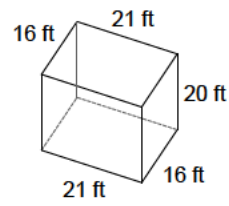

124)

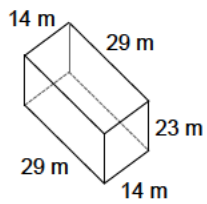

125)

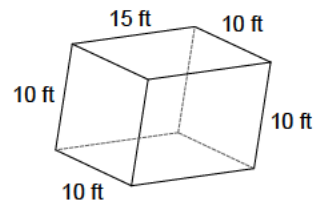

126)

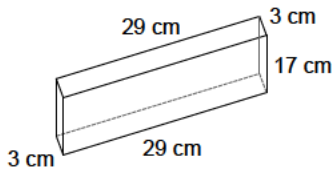

127)

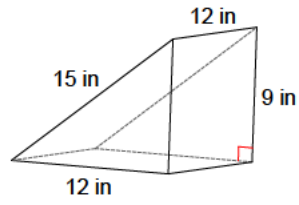

128)

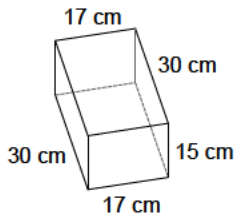

129)

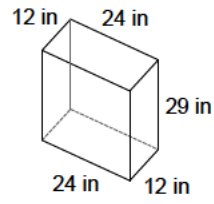

130)

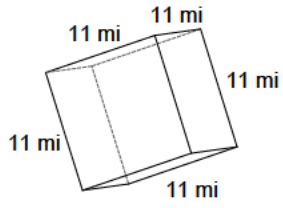

131)

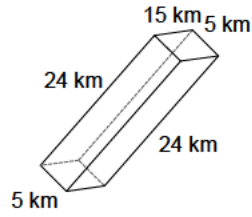

132)

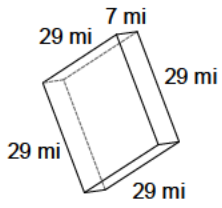

133)

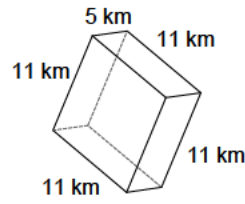

134)

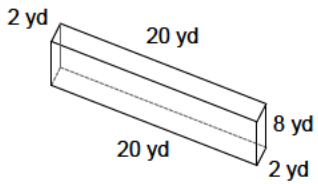

135)

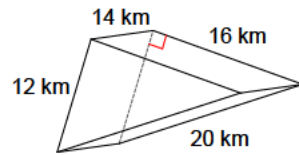

136)

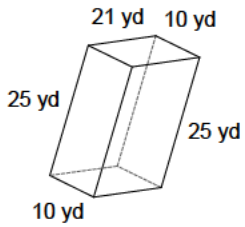

137)

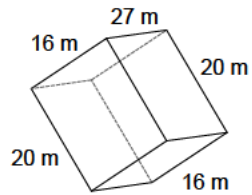

138)

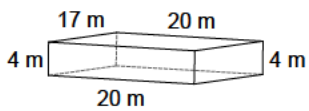

139)

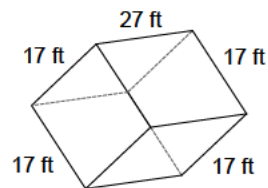

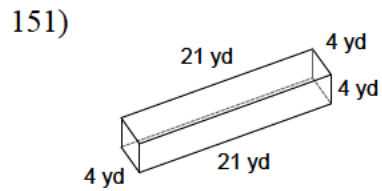
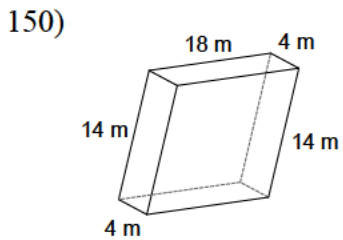
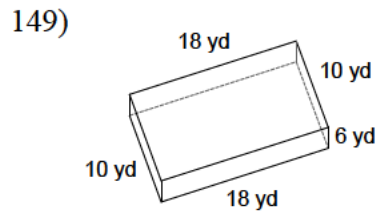
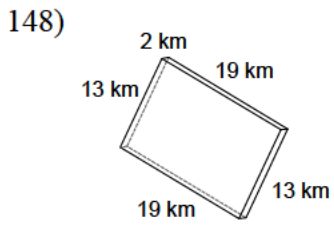
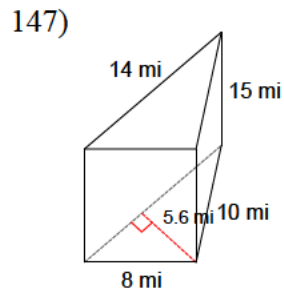
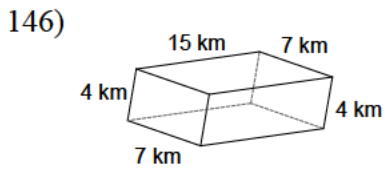
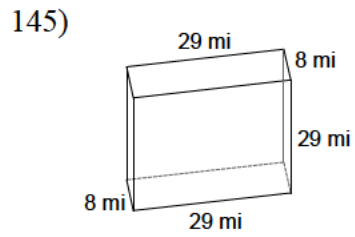
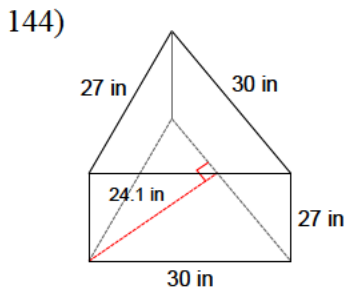
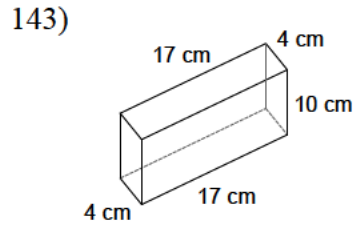
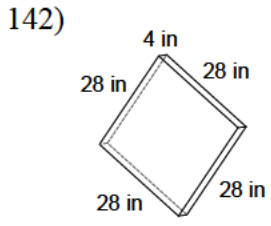
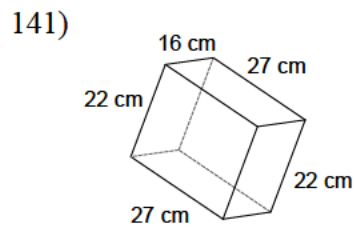
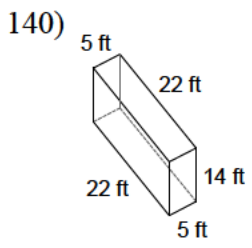

152)

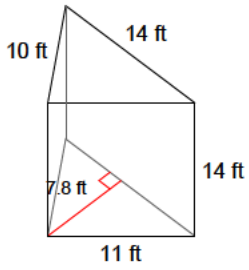

153)

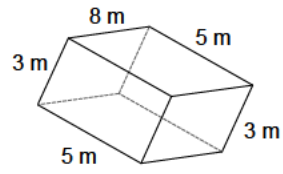

154)

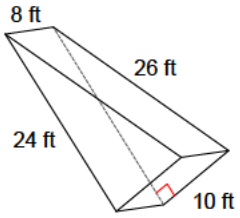

155)

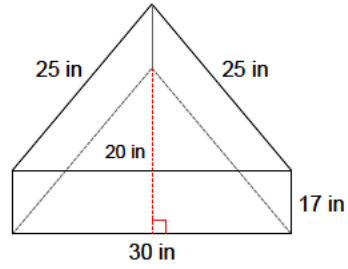

156)

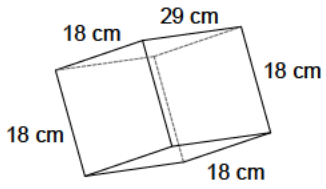

157)

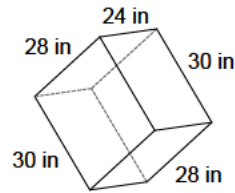

158)

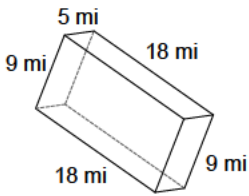

159)

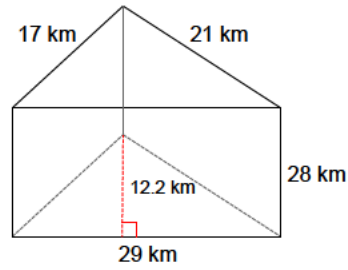

160)

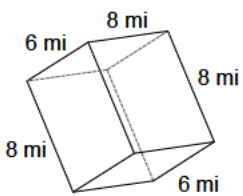

161)

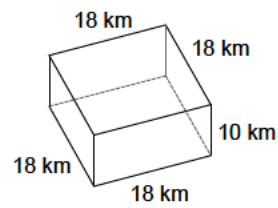

162)

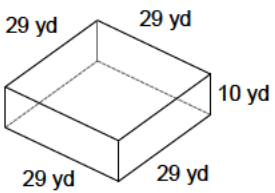

163)

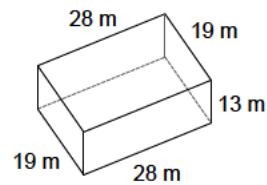

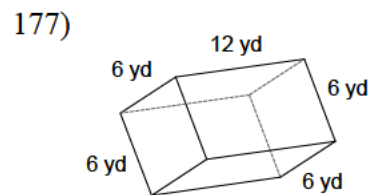
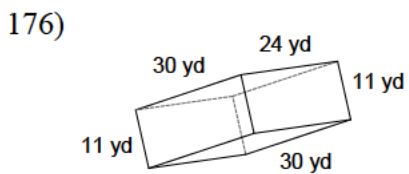
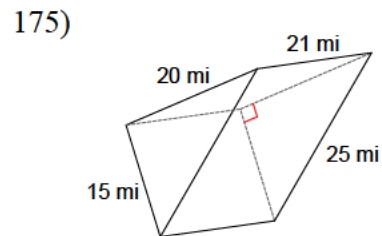
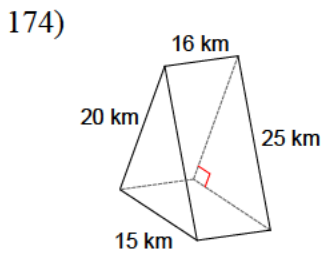
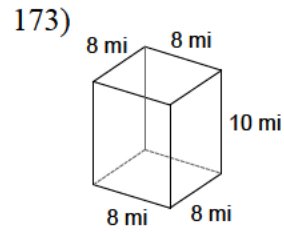
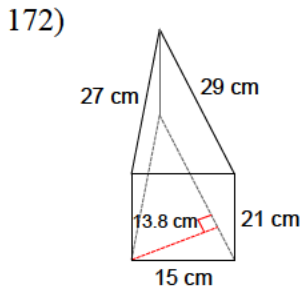
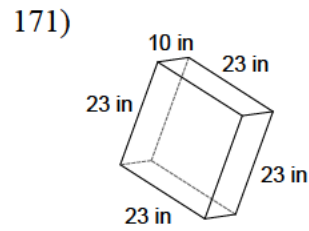
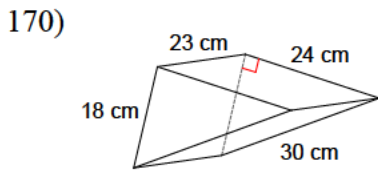
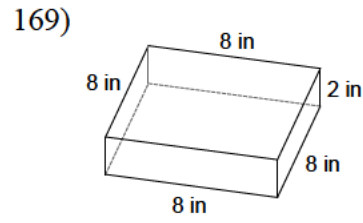
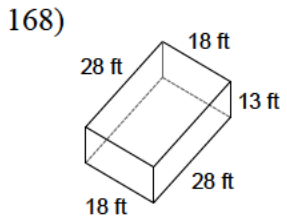
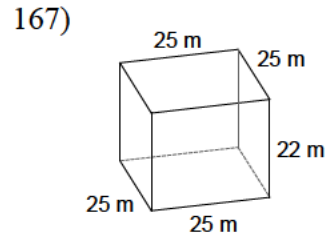
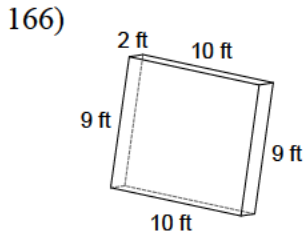
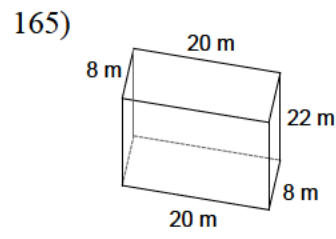
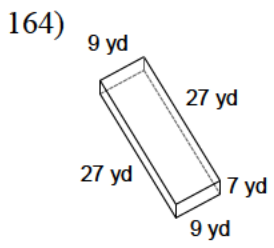

178)

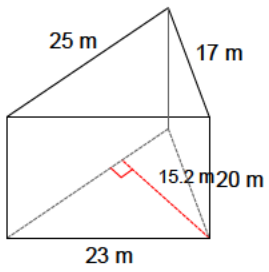

179)

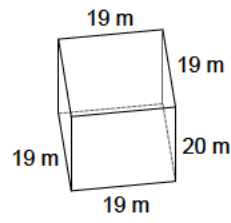

180)

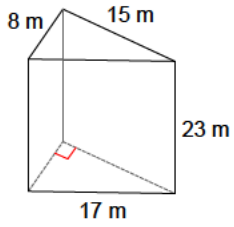

181)

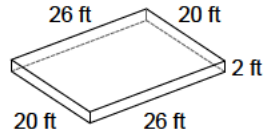

182)

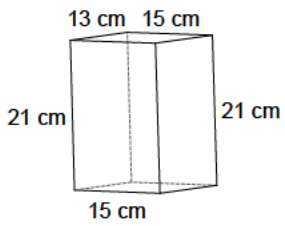

183)

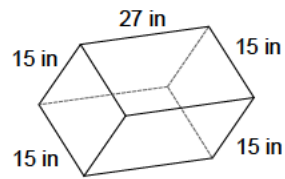

184)

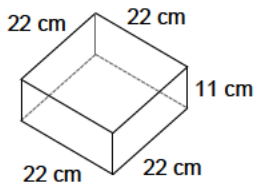

185)

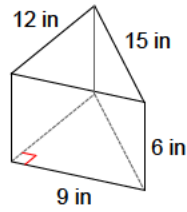

186)

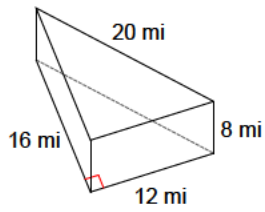

187)

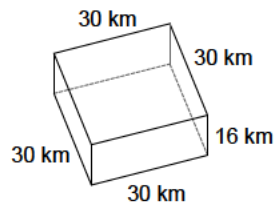

188)

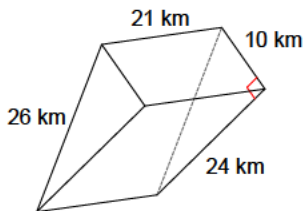

189)

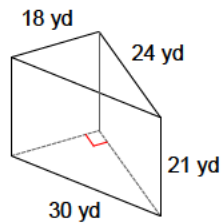

190)

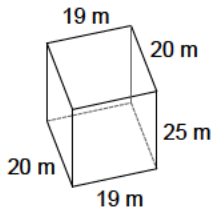

191)

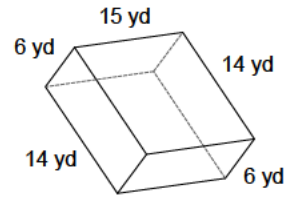

192)

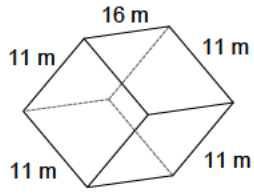

193)

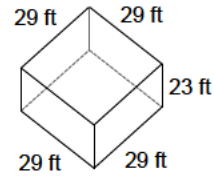

194)

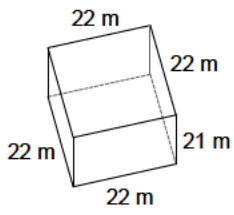

195)

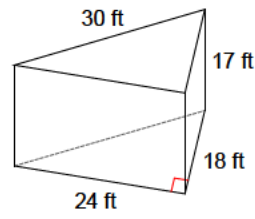

196)

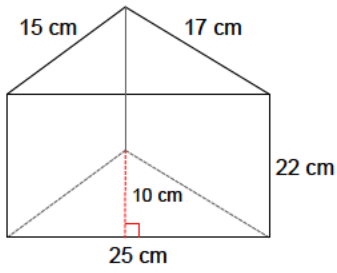

197)

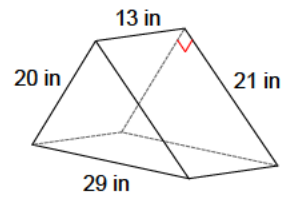

198)

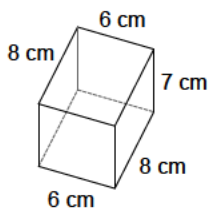

199)

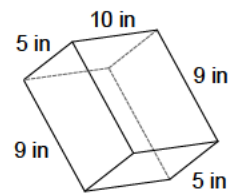

200)

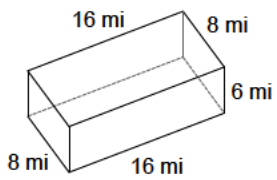

Find the volume of each prism or pyramid:

201)

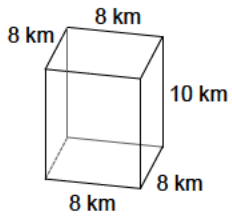

202)

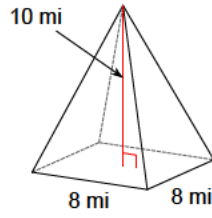

203)

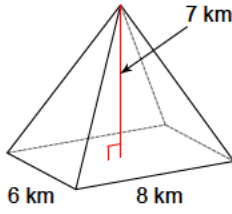

204)

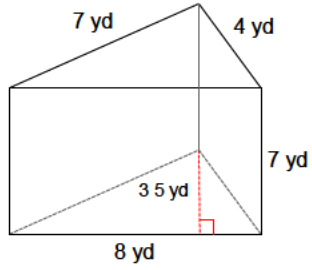

205)

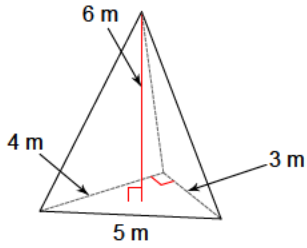

206)

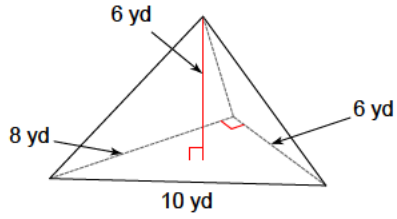

207)

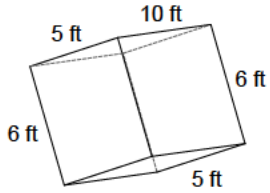

208)

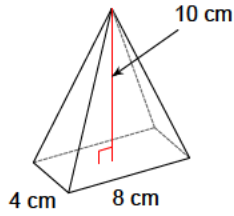

209)

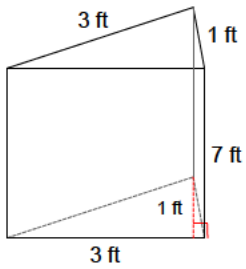

210)

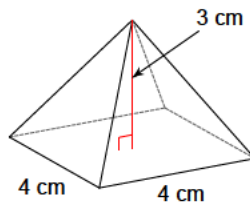

211)

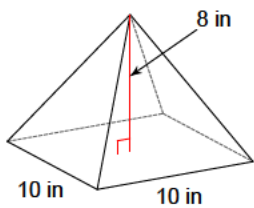

212)

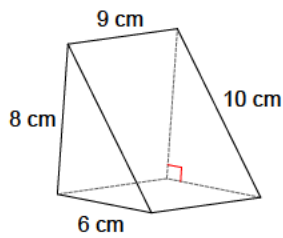

213)

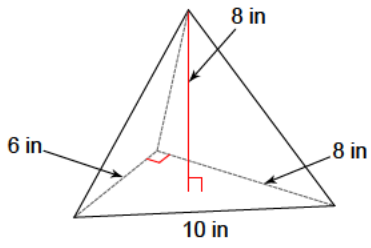

214)

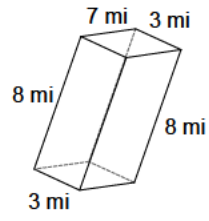

215)

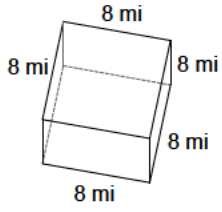

216)

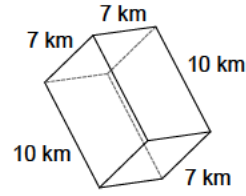

217)

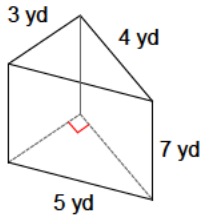

218)

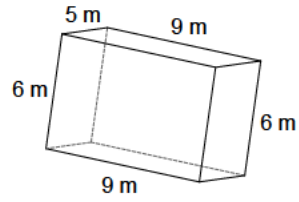

219)

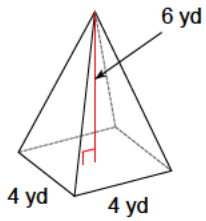

220)

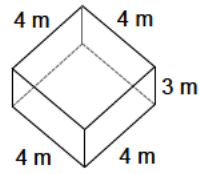

221)

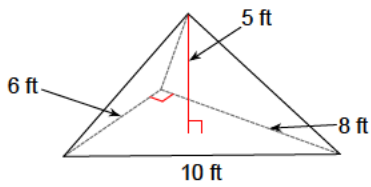

222)

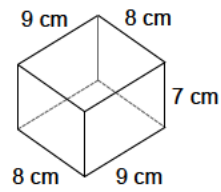

223)

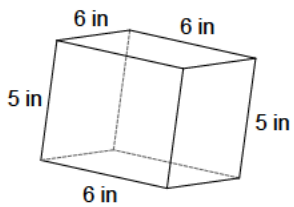

224)

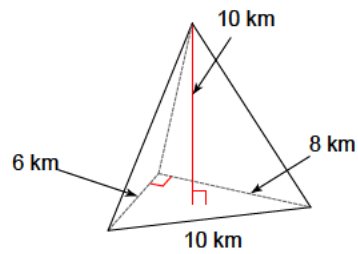

225)

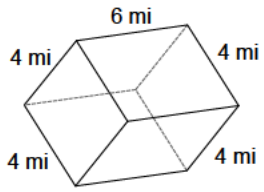

226)

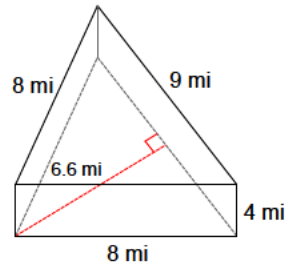

227)

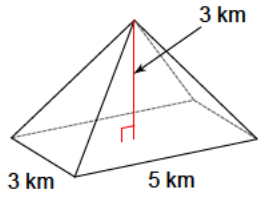

228)

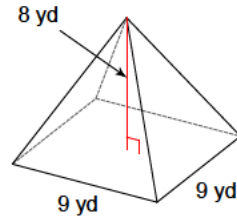

229)

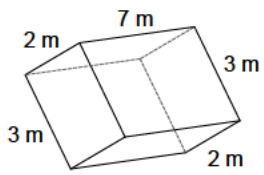

230)

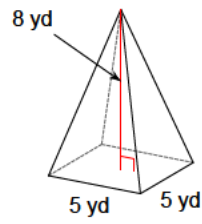

231)

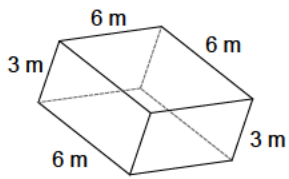

232)

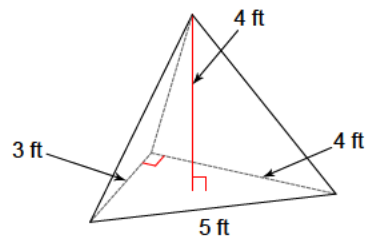

233)

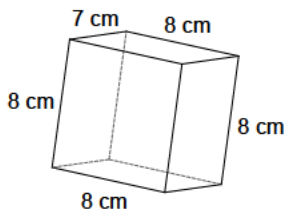

234)

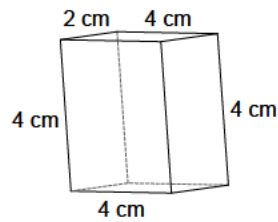

235)

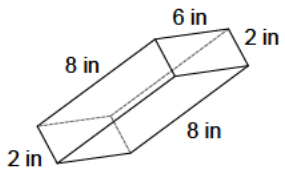

236)

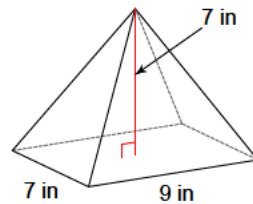

237)

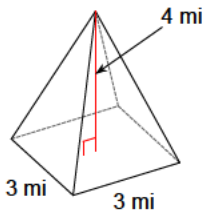

238)

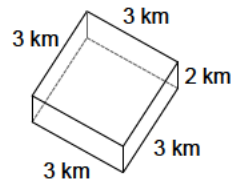

239)

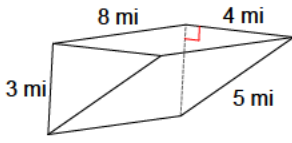

240)

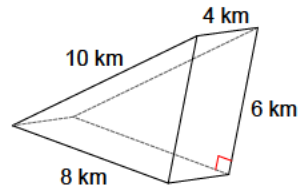

241)

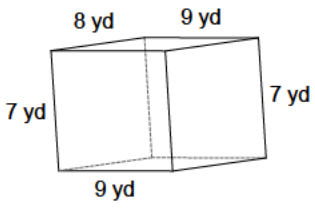

242)

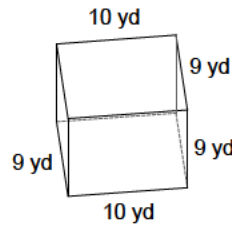

243)

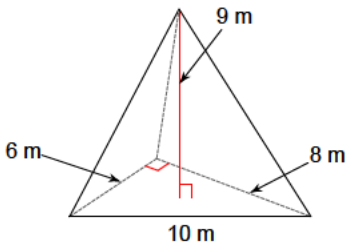

244)

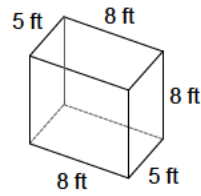

245)

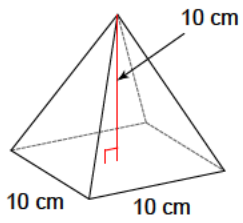

246)

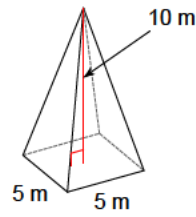

247)

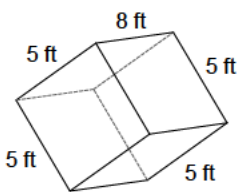

248)

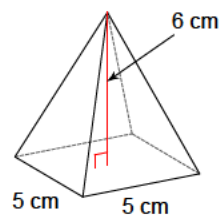

249)

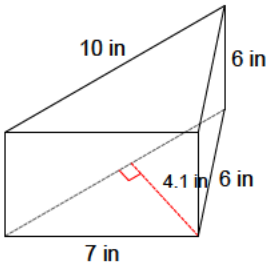

250)

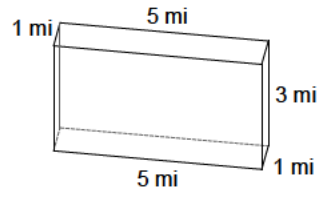

251)

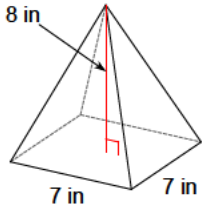

252)

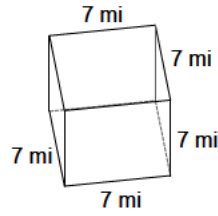

253)

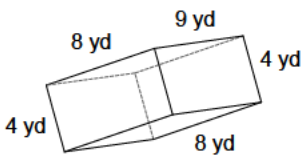

254)

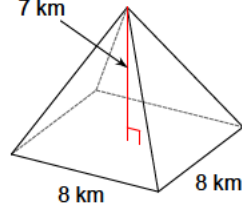

255)

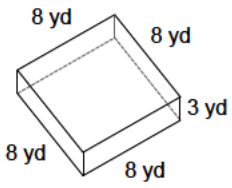

256)

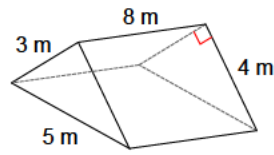

257)

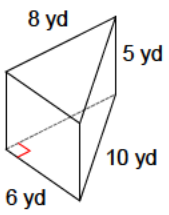

258)

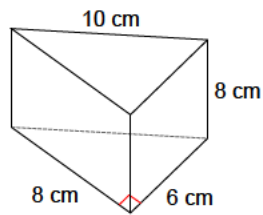

259)

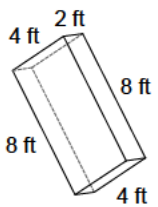

260)

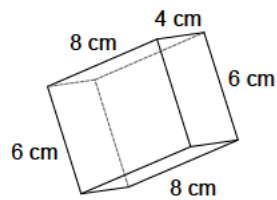

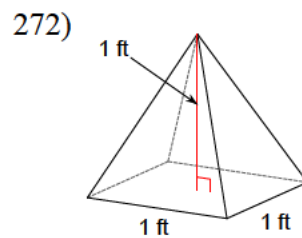
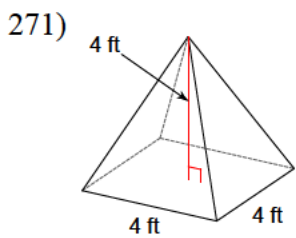
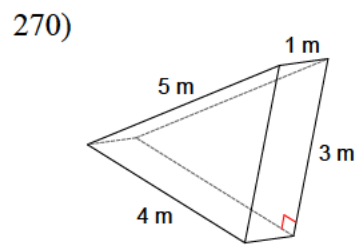
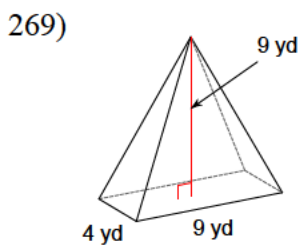
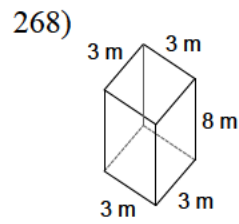
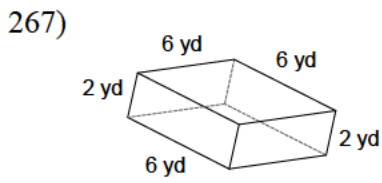
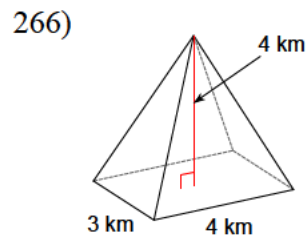
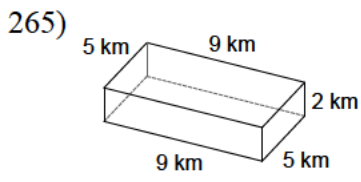
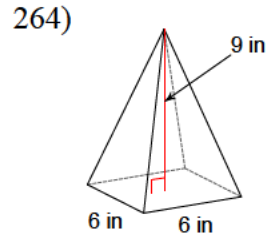
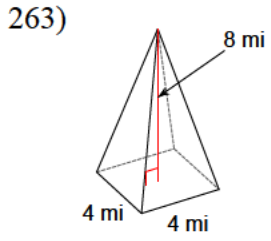
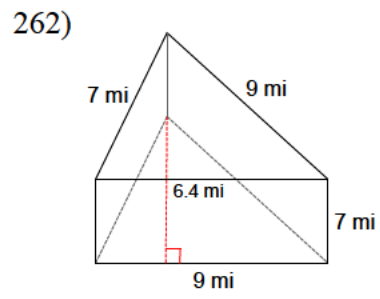
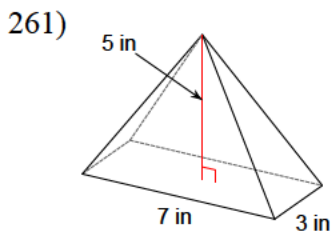

273)

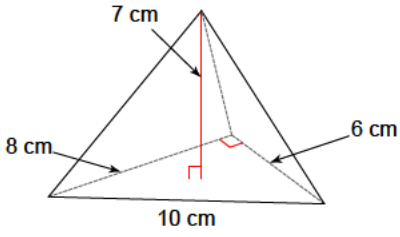

274)

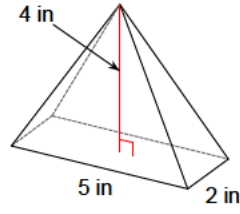

275)

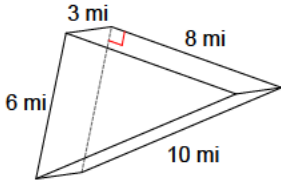

276)

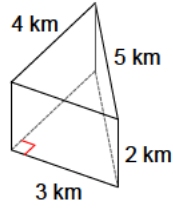

277)

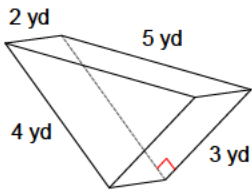

278)

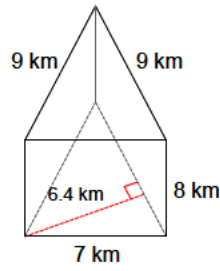

279)

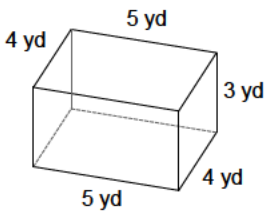

280)

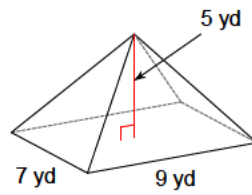

281)

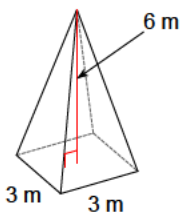

282)

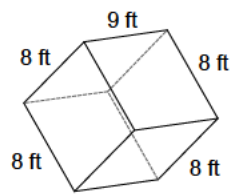

283)

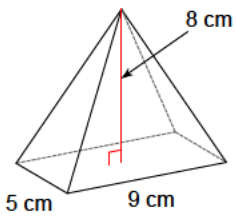

284)

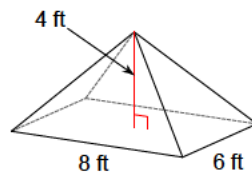

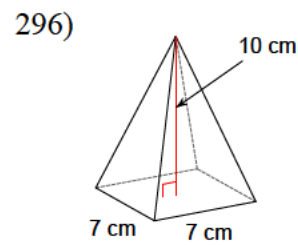
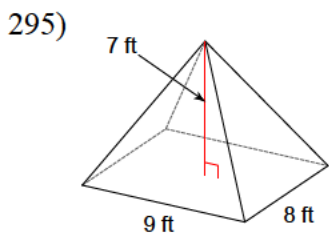
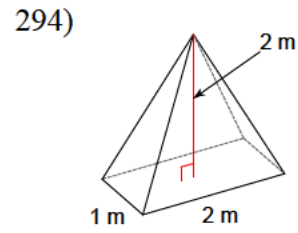
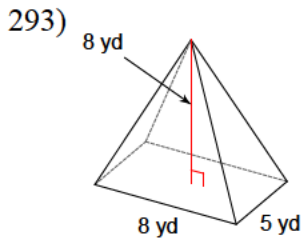
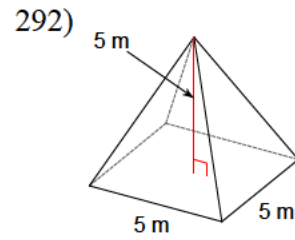
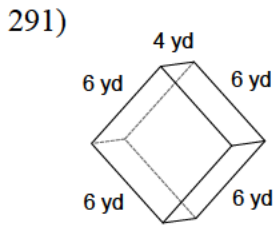
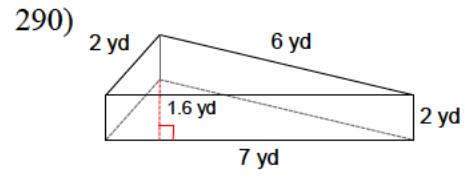
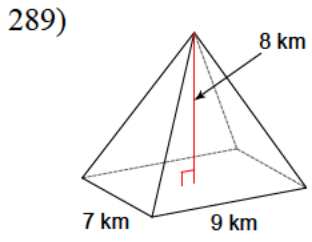
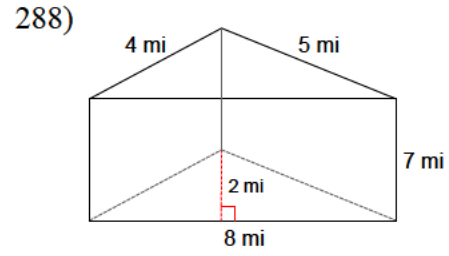
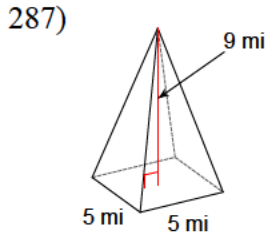
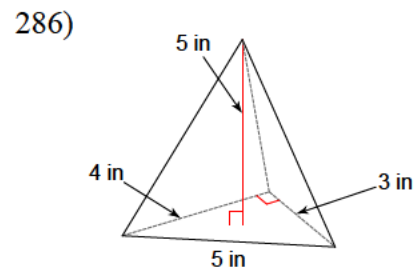
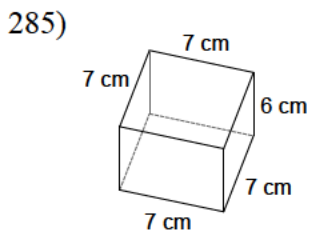

297)

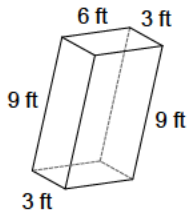

298)

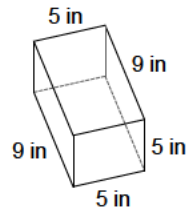

299)

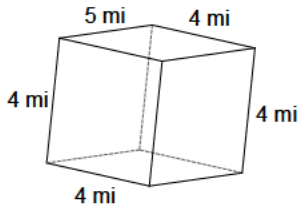

300)

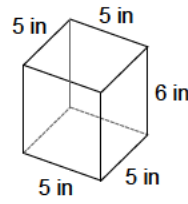

301)

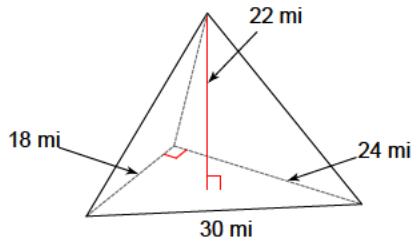

302)

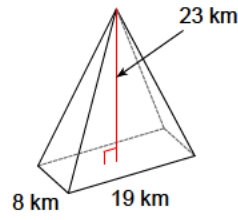

303)

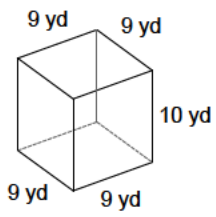

304)

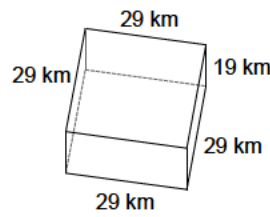

305)

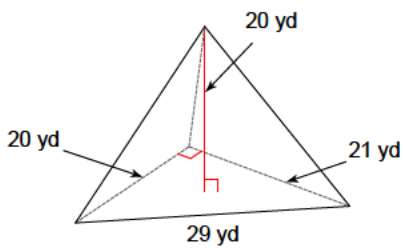

306)

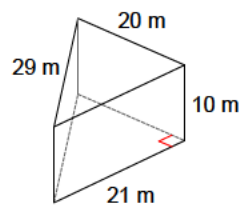

307)

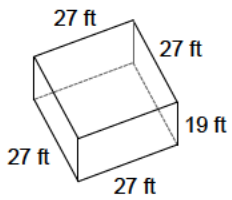

308)

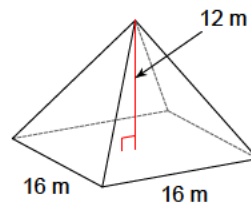

309)

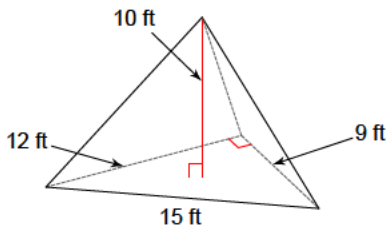

310)

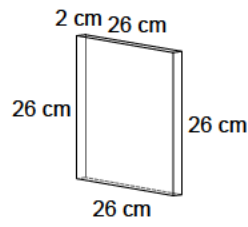

311)

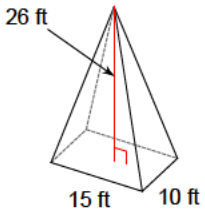

312)

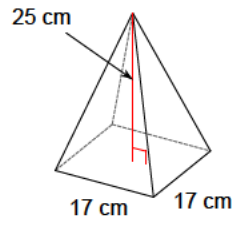

313)

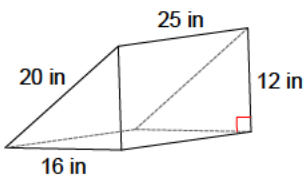

314)

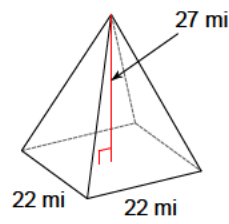

315)

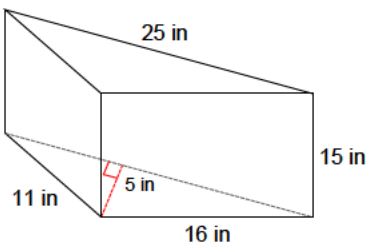

316)

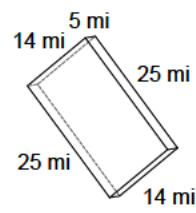

317)

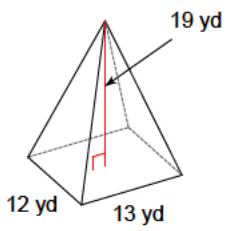

318)

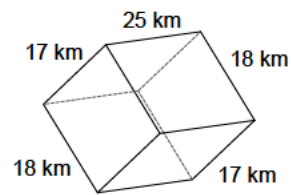

319)

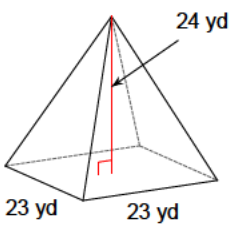

320)

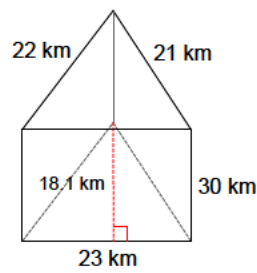

321)

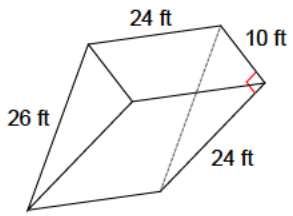

322)

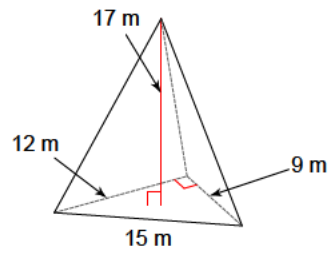

323)

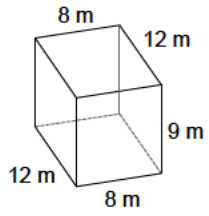

324)

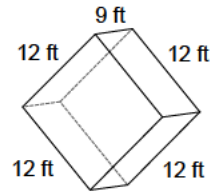

325)

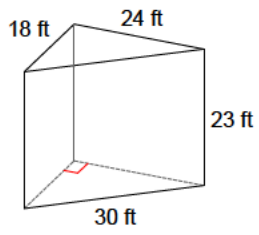

326)

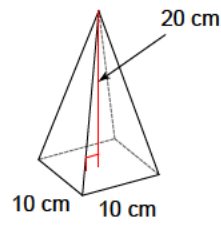

327)

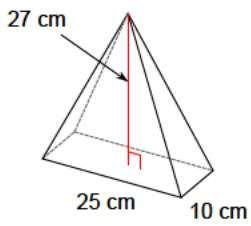

328)

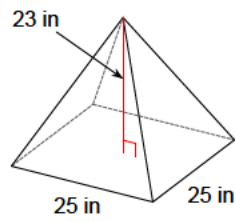

329)

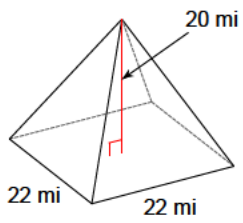

330)

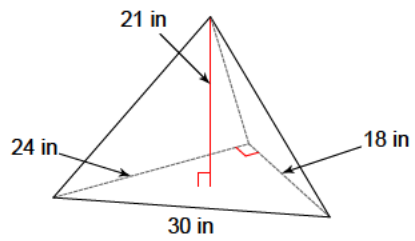

331)

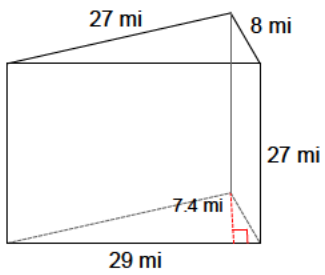

332)

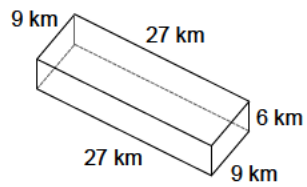

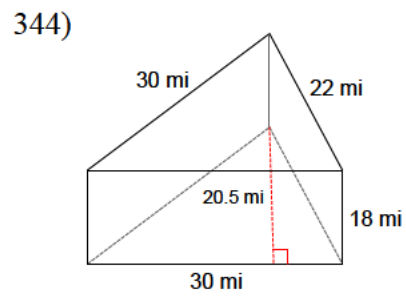
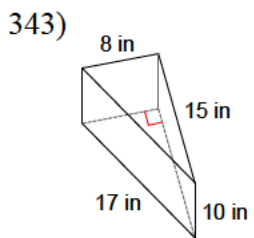
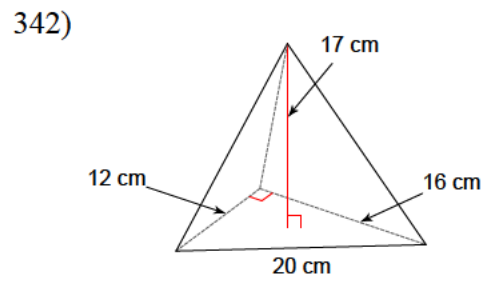
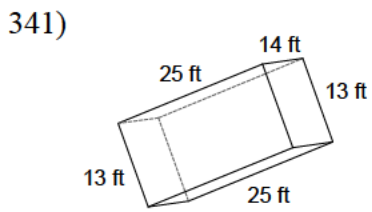
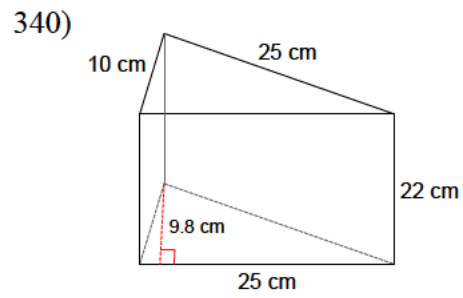
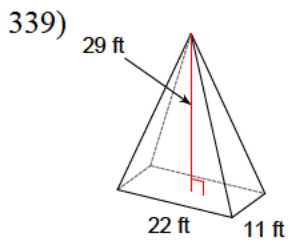
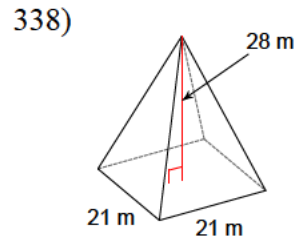
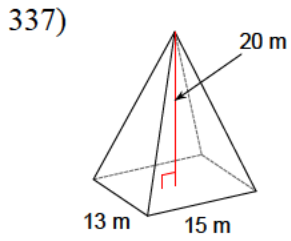
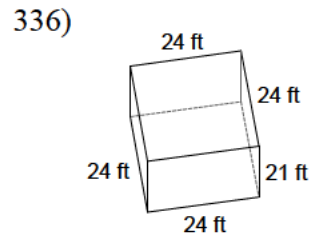
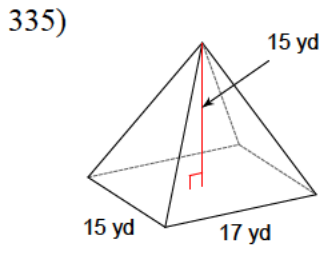
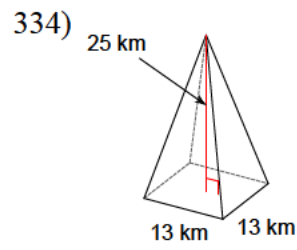
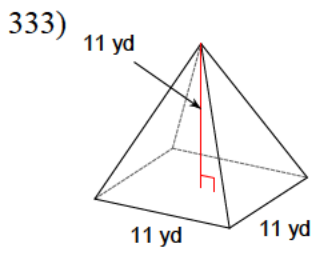

345)

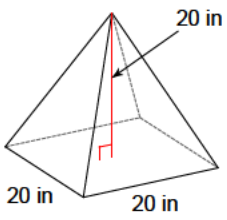

346)

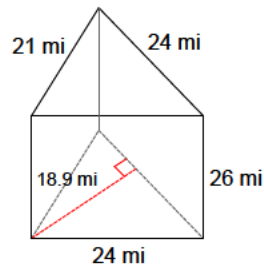

347)

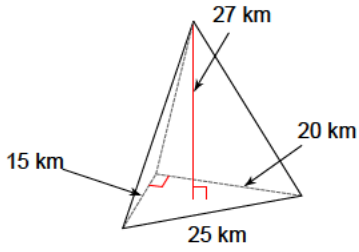

348)

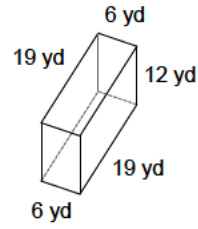

349)

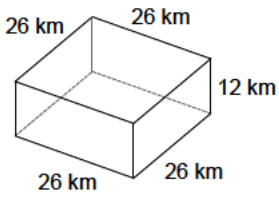

350)

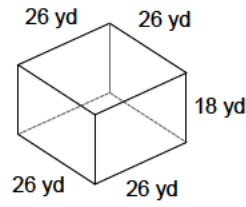

351)

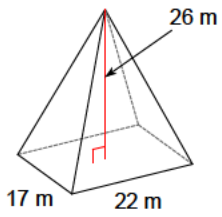

352)

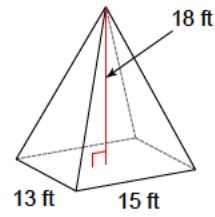

353)

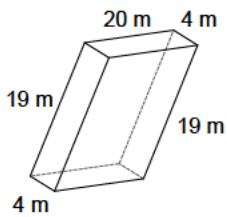

354)

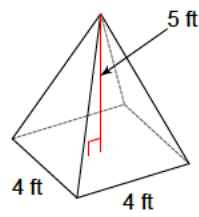

355)

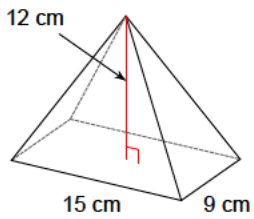

356)

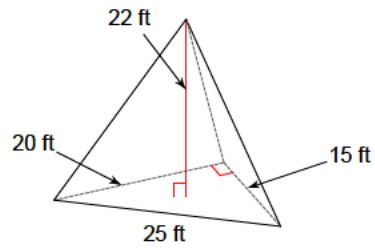

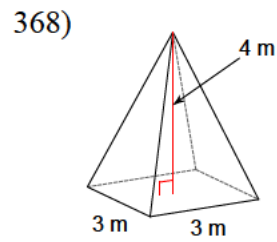
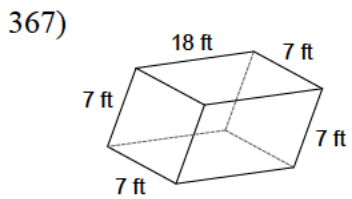
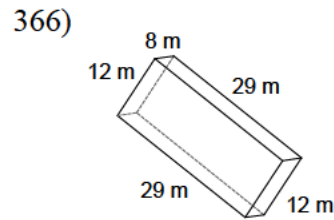
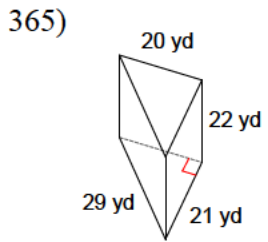
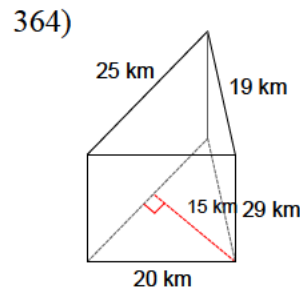
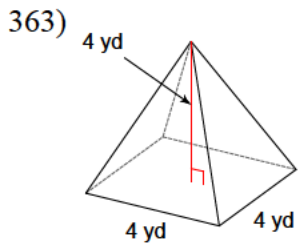
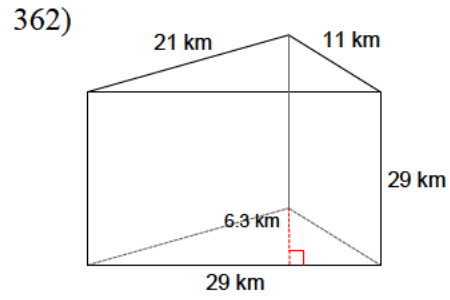
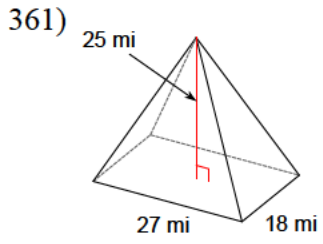
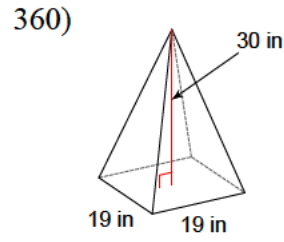
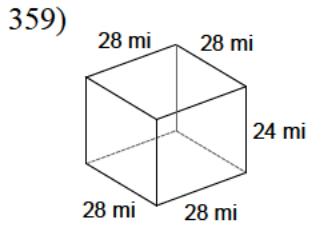
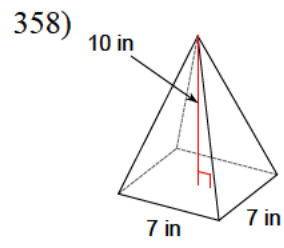
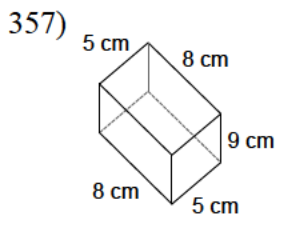

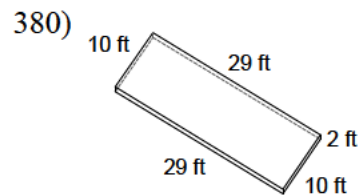
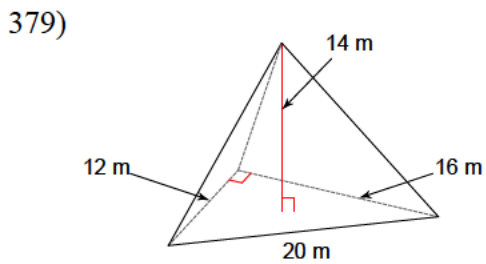
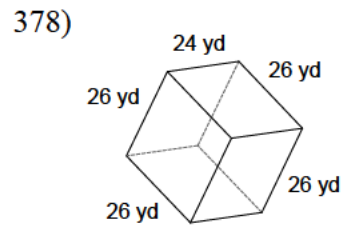
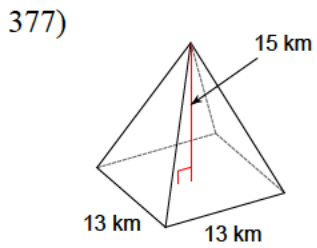
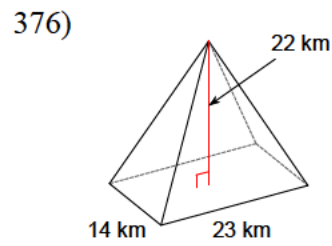
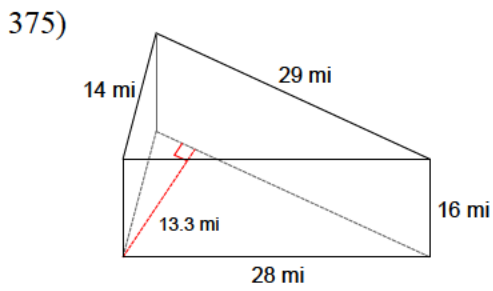
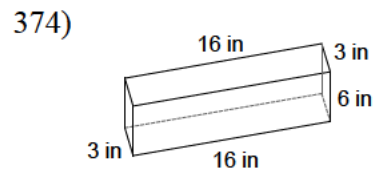
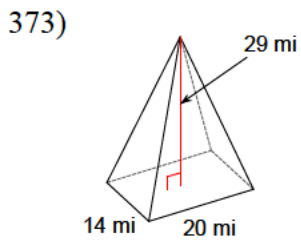
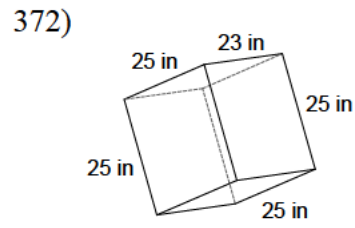
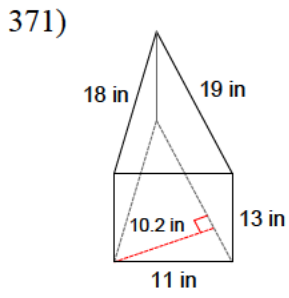
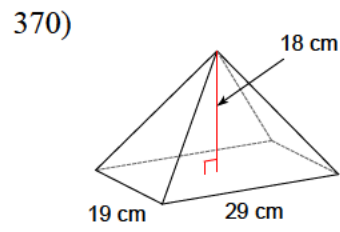
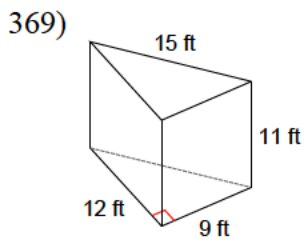

381)

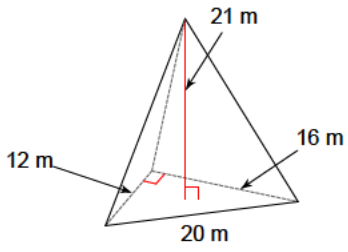

382)

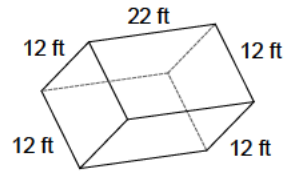

383)

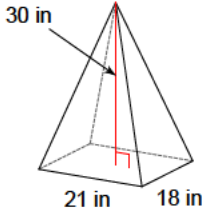

384)

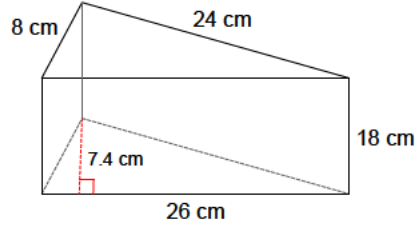

385)

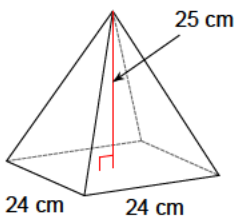

386)

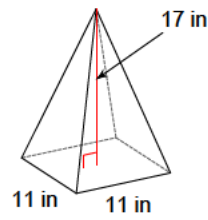

387)

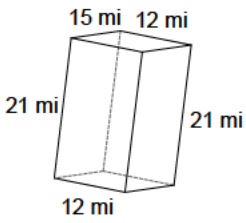

388)

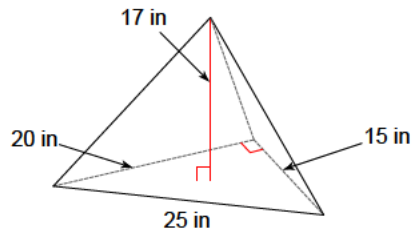

389)

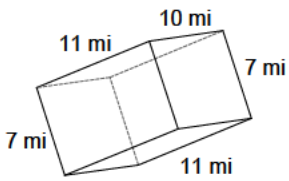

390)

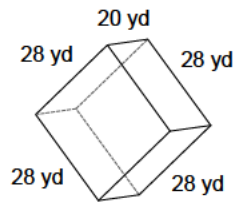

391)

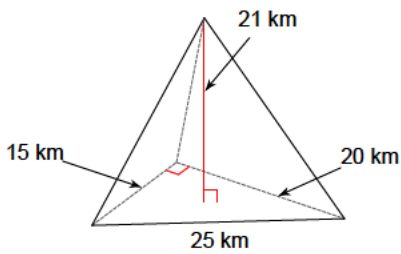

392)

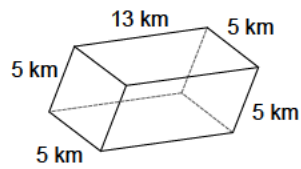

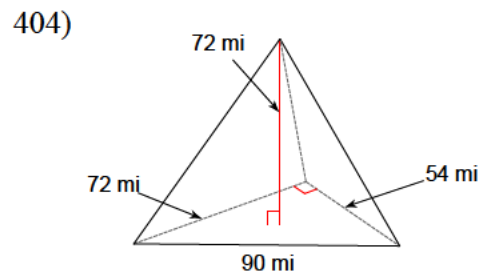
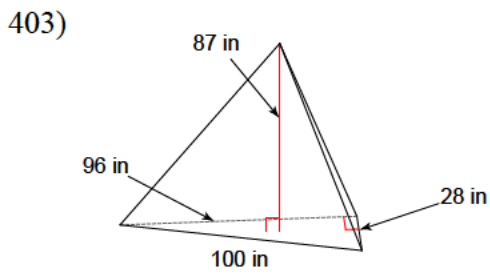
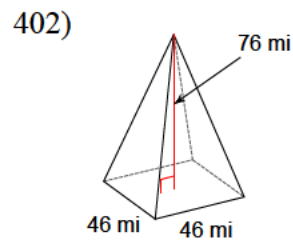
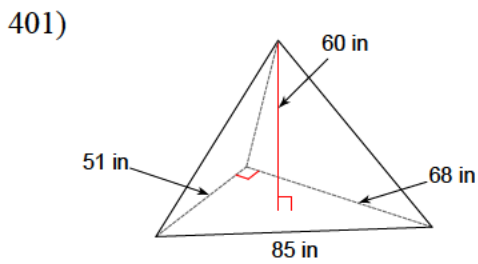
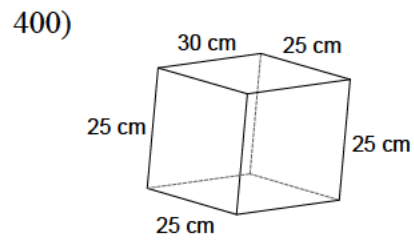
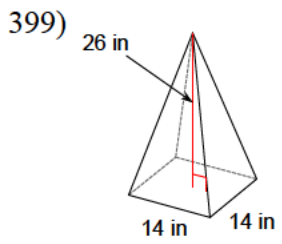
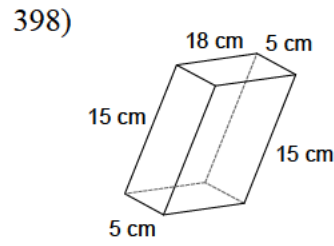
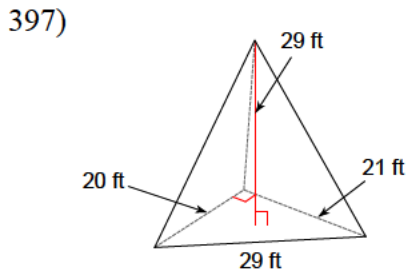
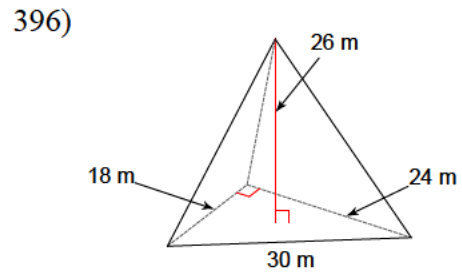
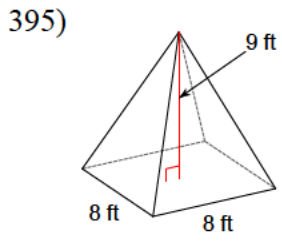
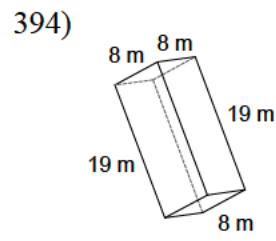
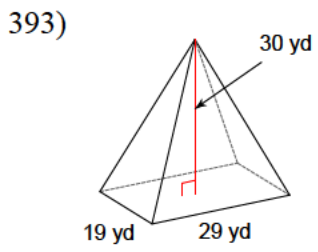

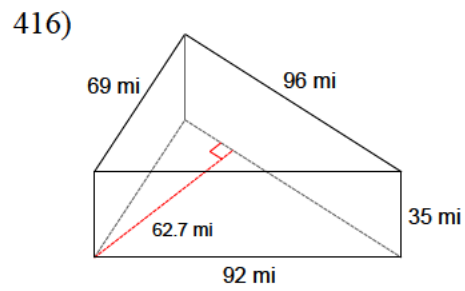
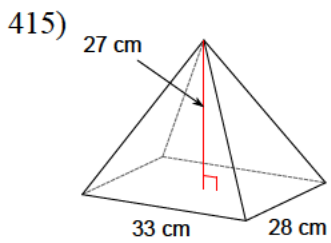
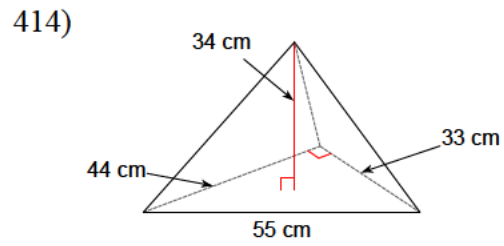
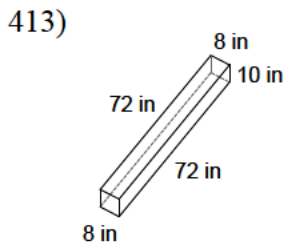
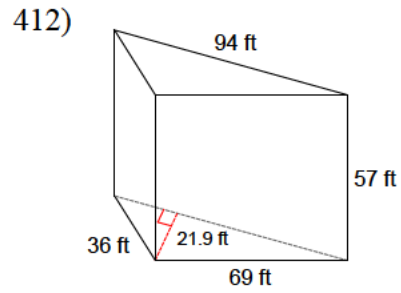
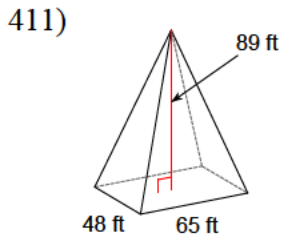
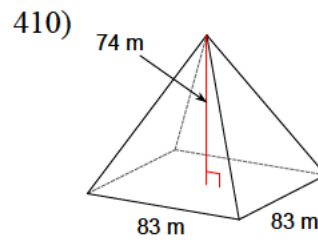
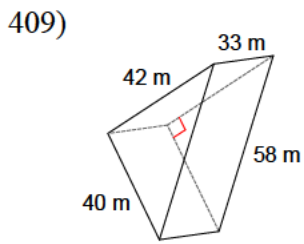
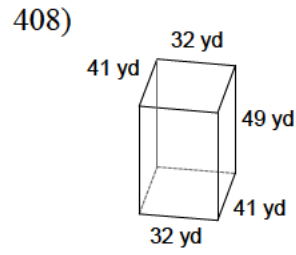
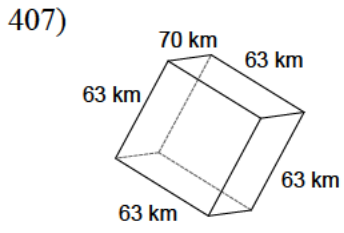
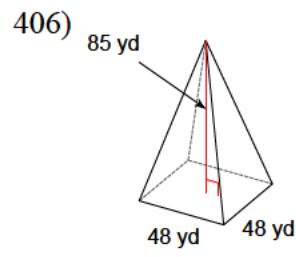
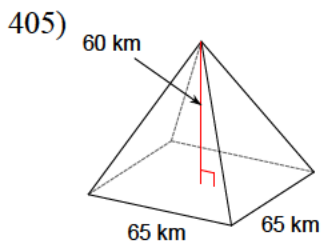

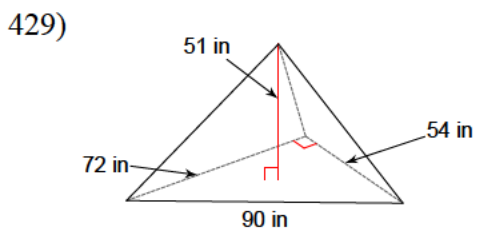
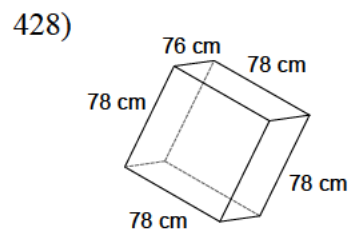
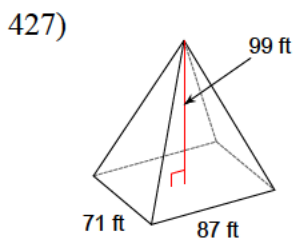
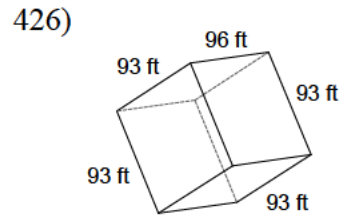
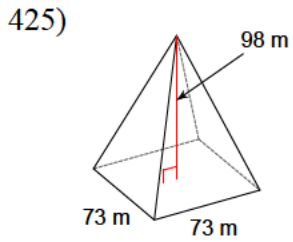
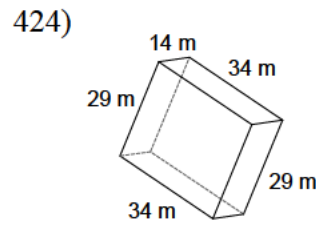
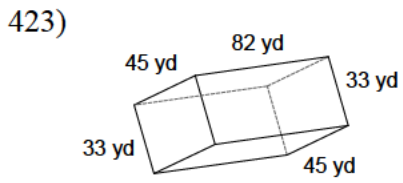
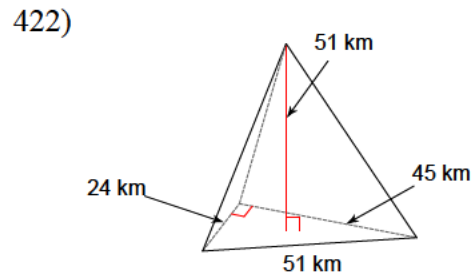
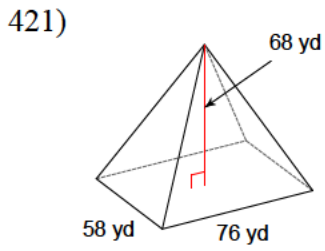
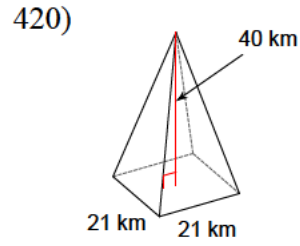
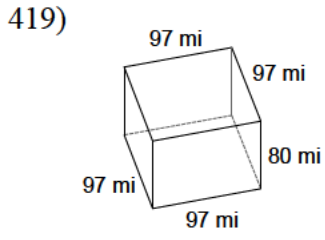
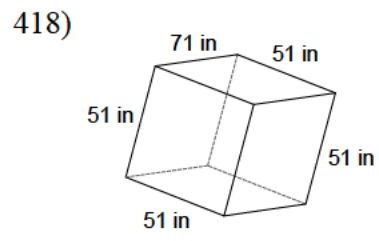
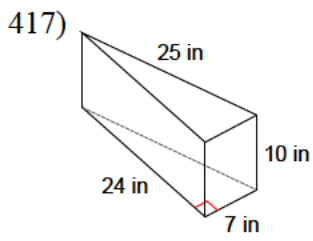

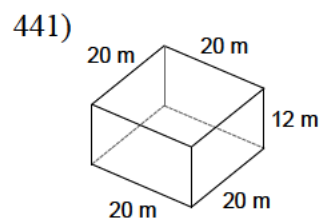
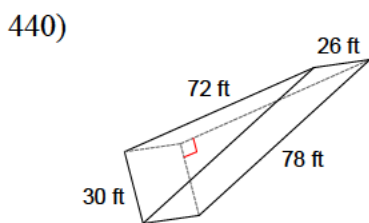
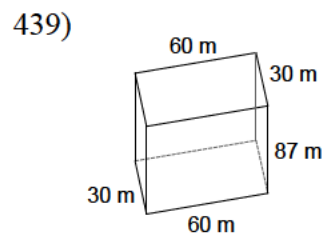
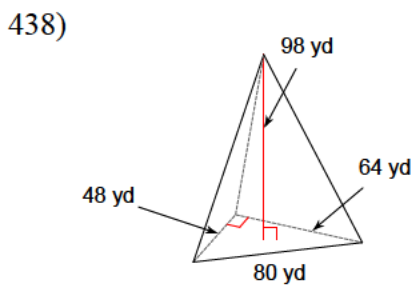
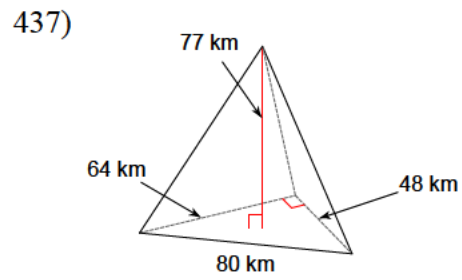
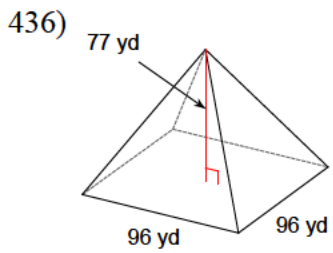
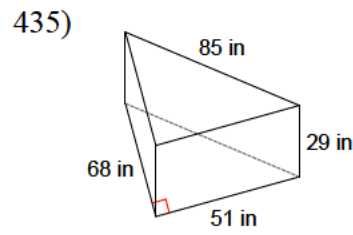
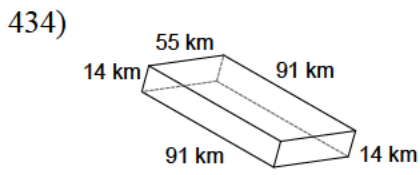
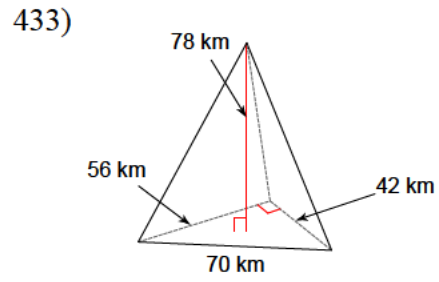
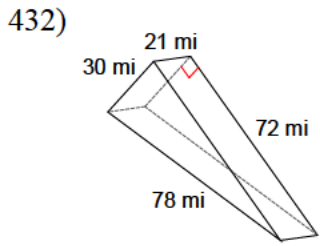
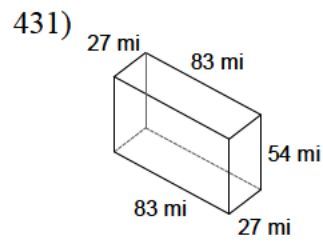
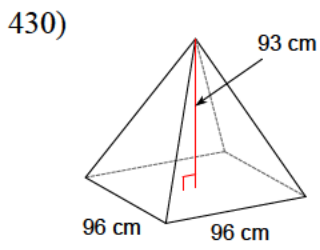

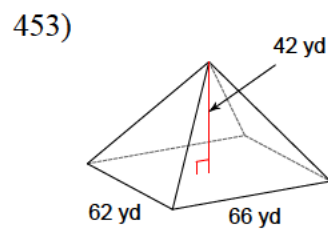
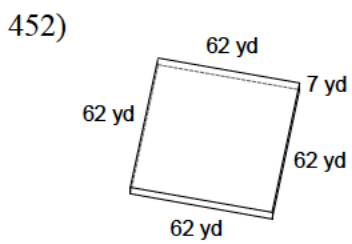
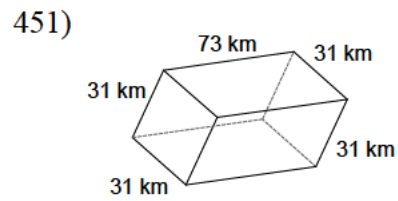
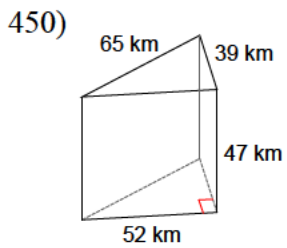
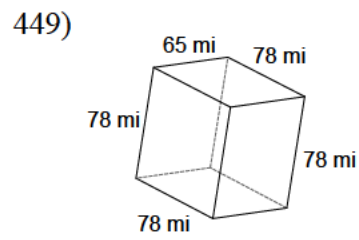
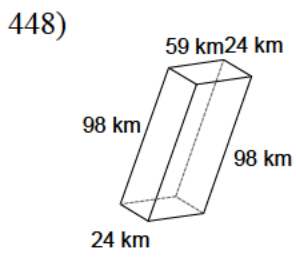
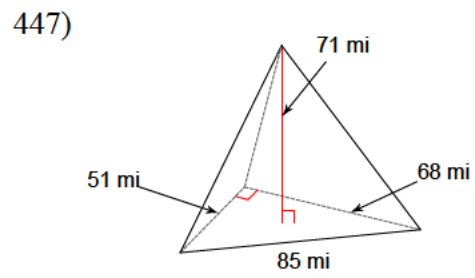
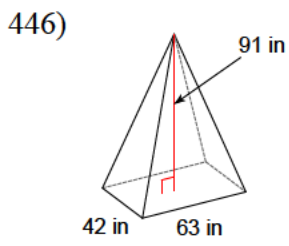
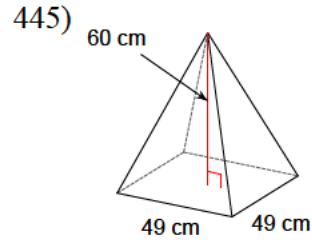
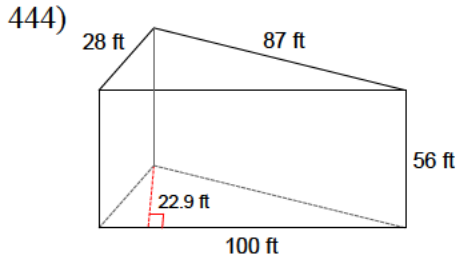
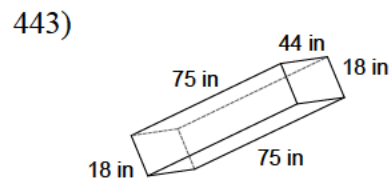
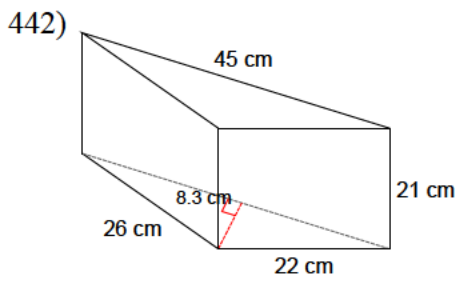

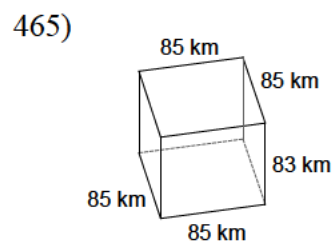
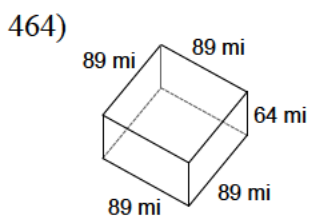
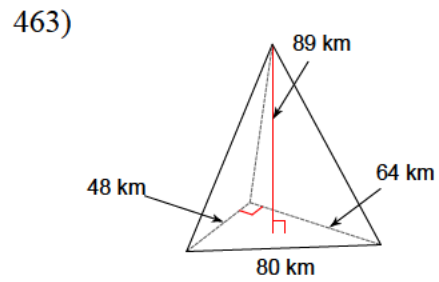
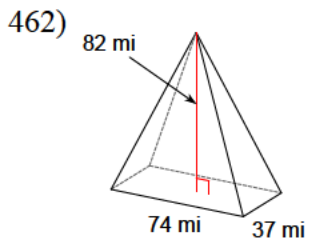
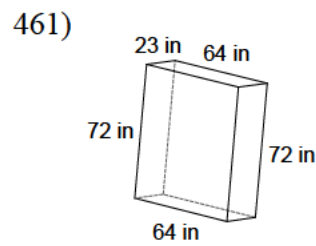
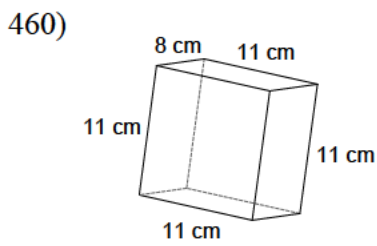
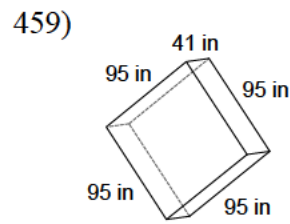
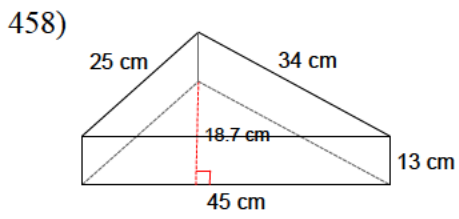
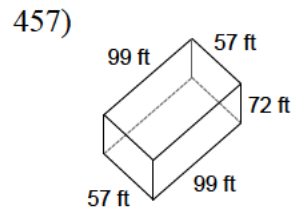
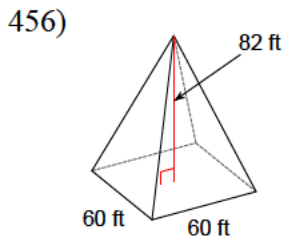
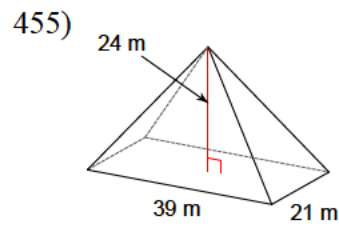
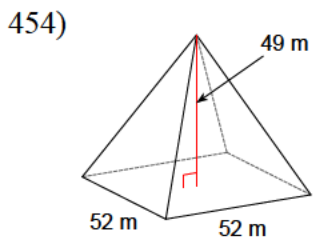

466)

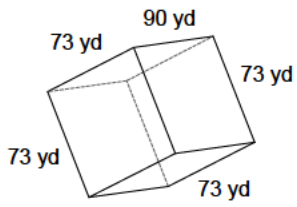

467)

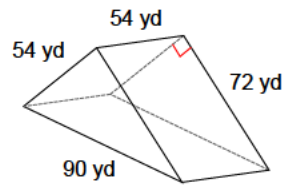

468)

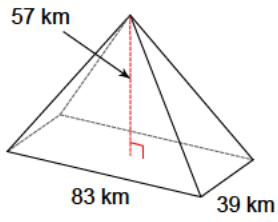

469)

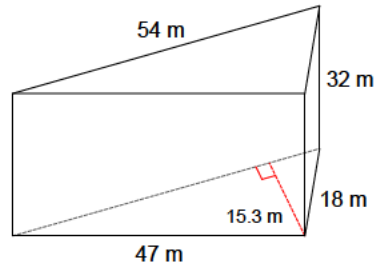

470)

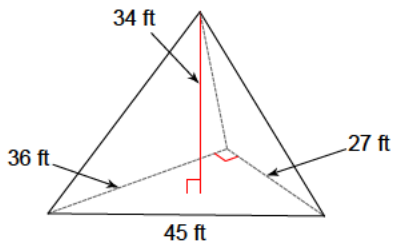

471)

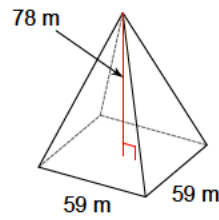

472)

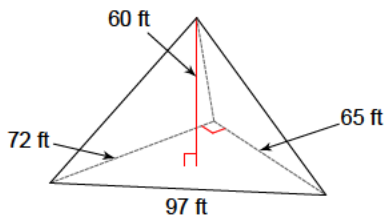

473)

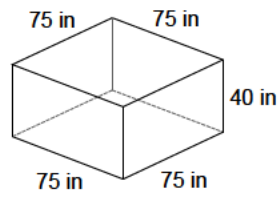

474)

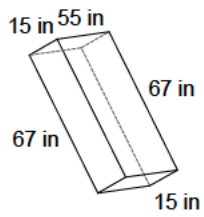

475)

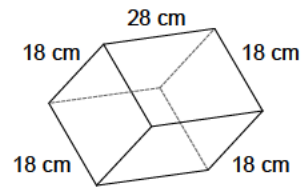

476)

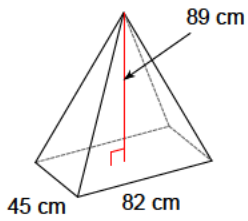

477)

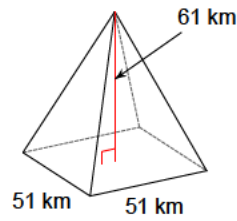

478)

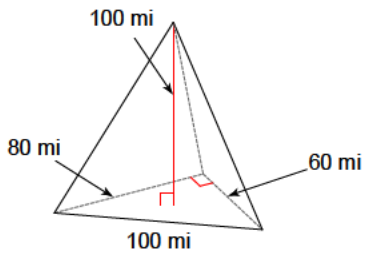

479)

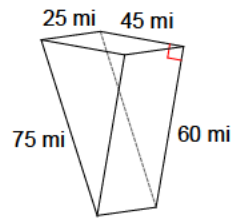

480)

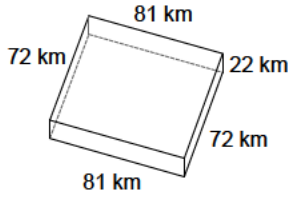

481)

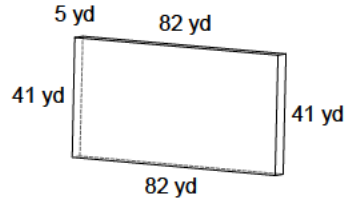

482)

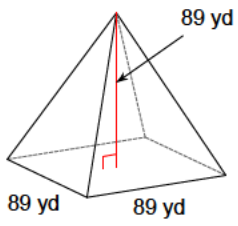

483)

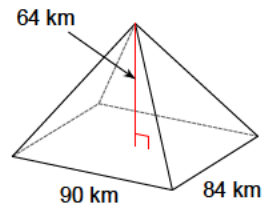

484)

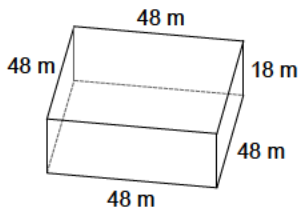

485)

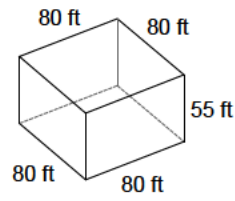

486)

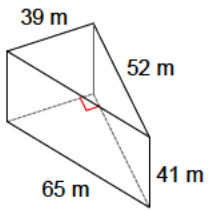

487)

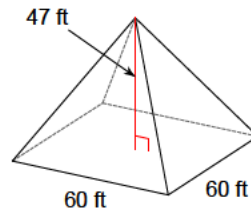

488)

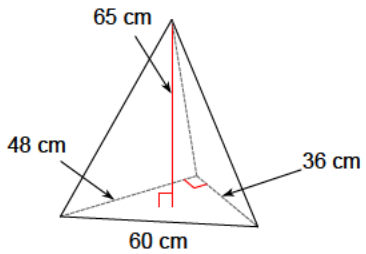

489)

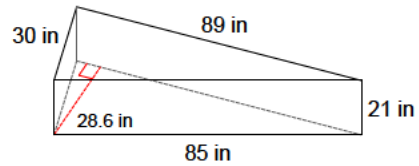

490)

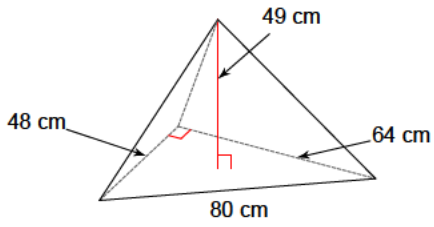

491)

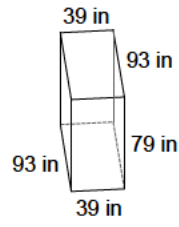

492)

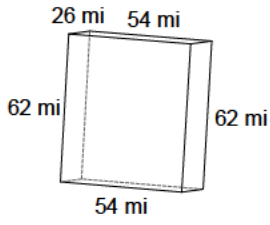

493)

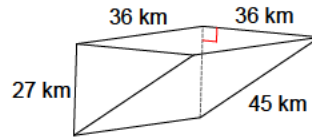

494)

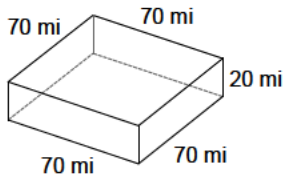

495)

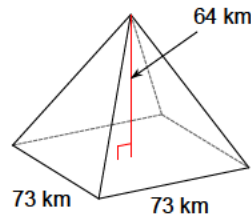

496)

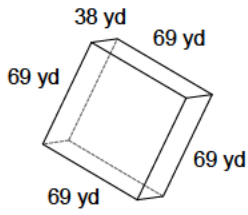

497)

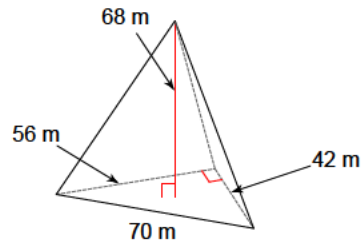

498)

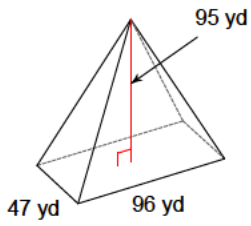

499)

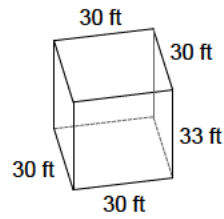

500)

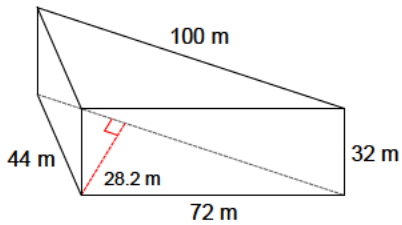

Find the volume of each prism, pyramid or cylinder:

501)

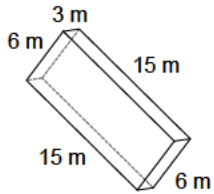

502)

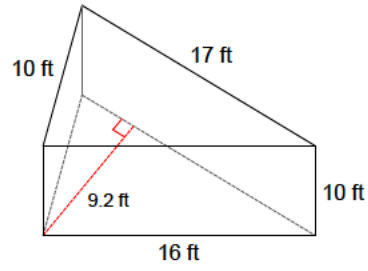

503)

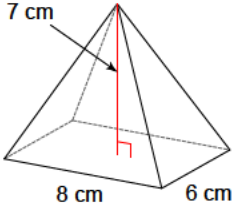

504)

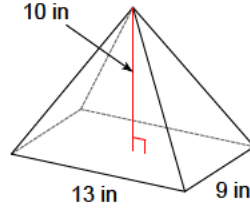

505)

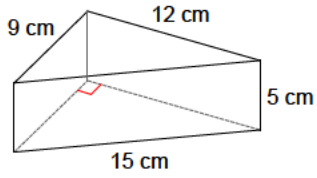

506)

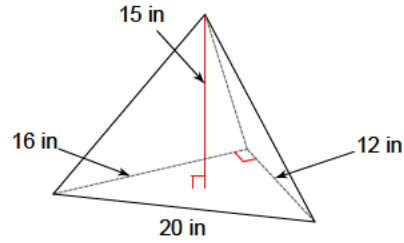

507)

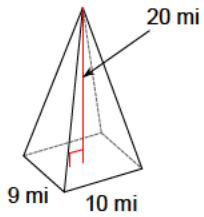

508)

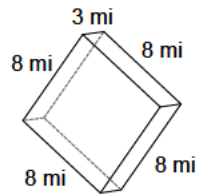

509)

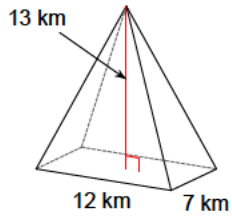

510)

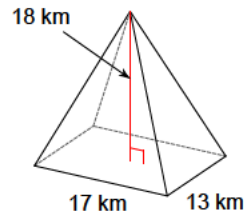

511)

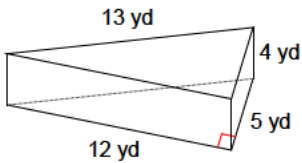

512)

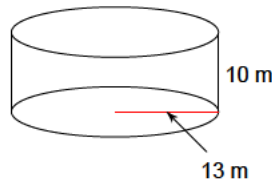

513)

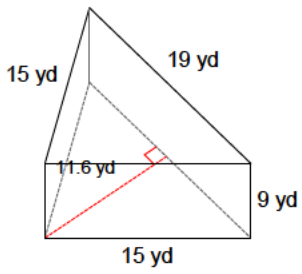

514)

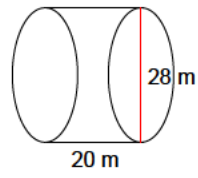

515)

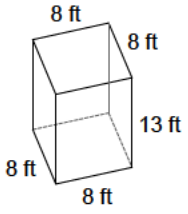

516)

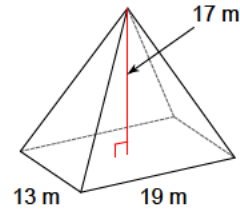

517)

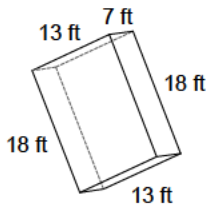

518)

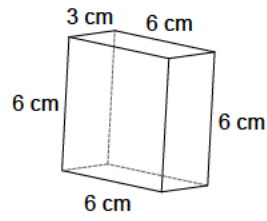

519)

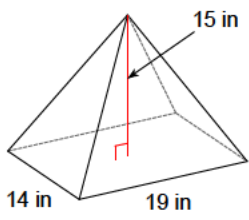

520)

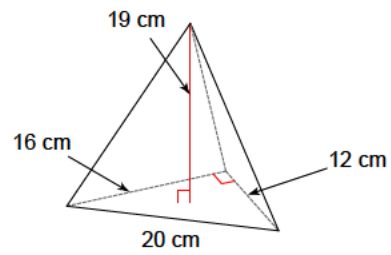

521)

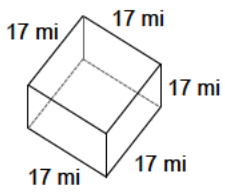

522)

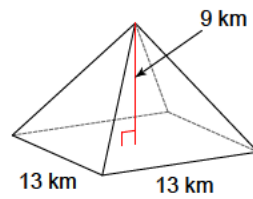

523)

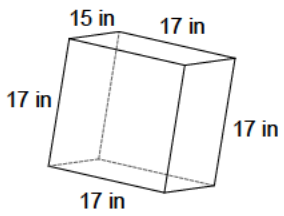

524)

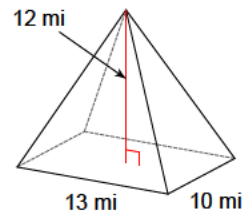

525)

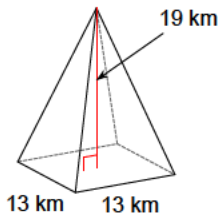

526)

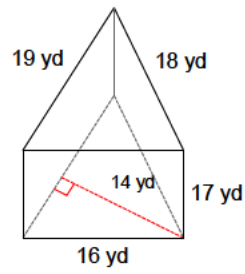

527)

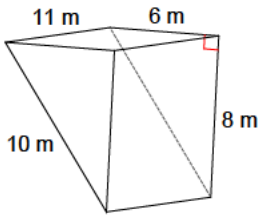

528)

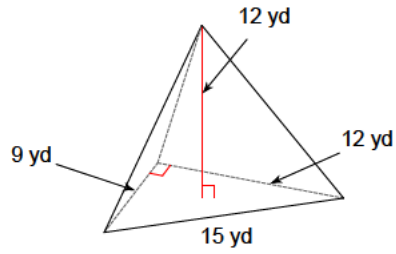

529)

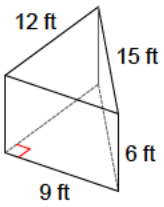

530)

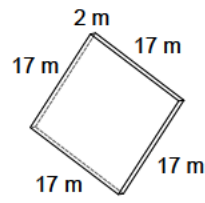

531)

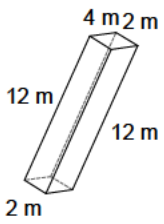

532)

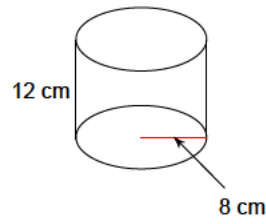

533)

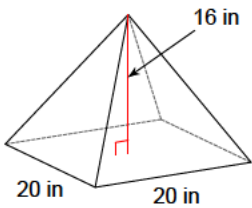

534)

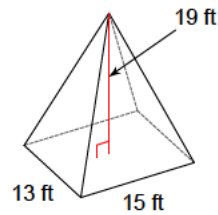

535)

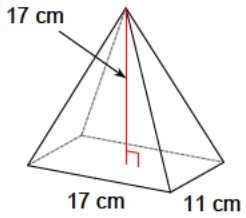

536)

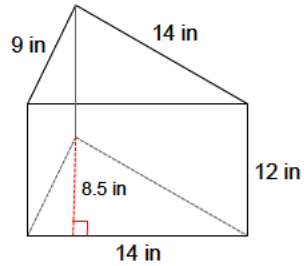

537)

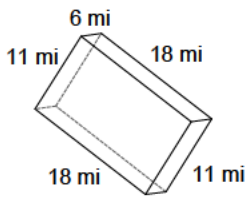

538)

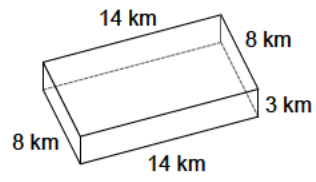

539)

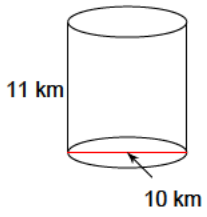

540)

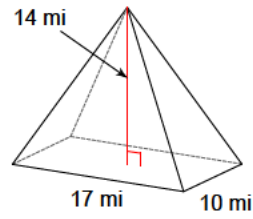

541)

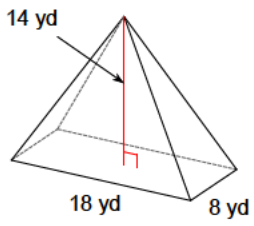

542)

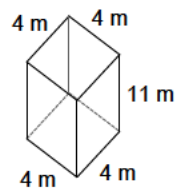

543)

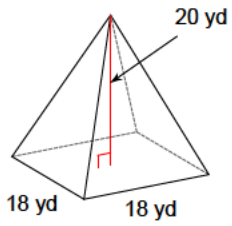

544)

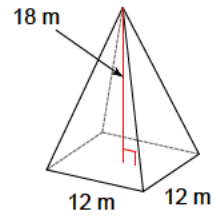

545)

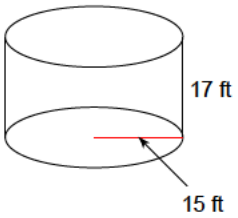

546)

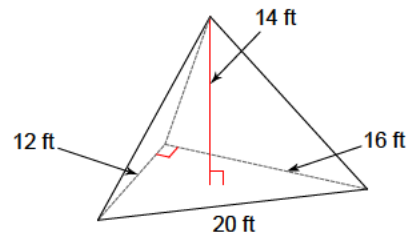

547)

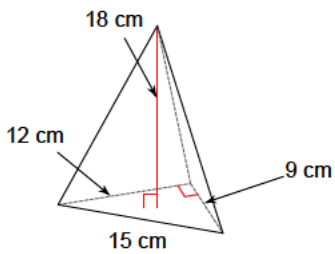

548)

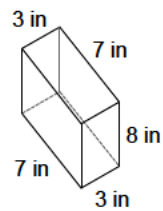

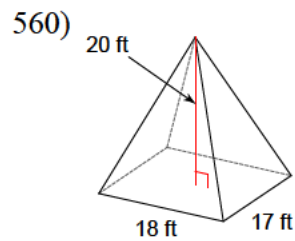
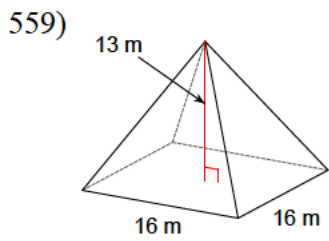
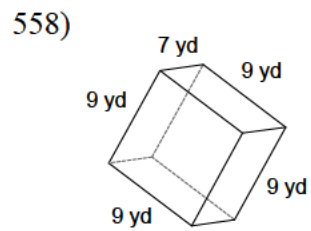
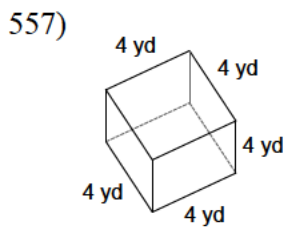
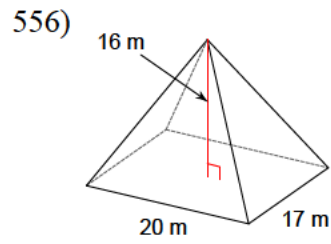
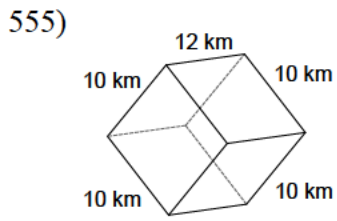
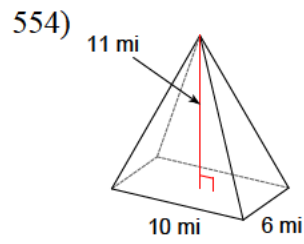
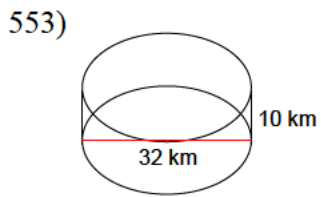
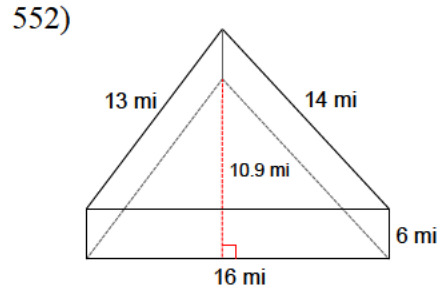
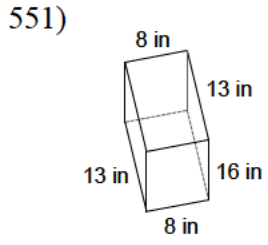
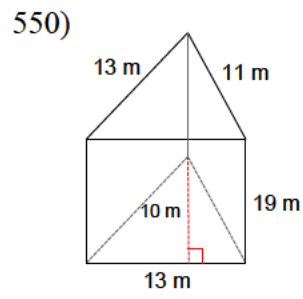
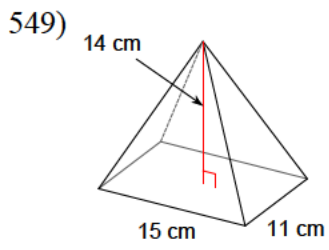

561)

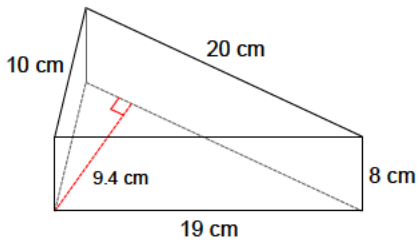

562)

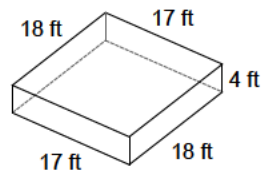

563)

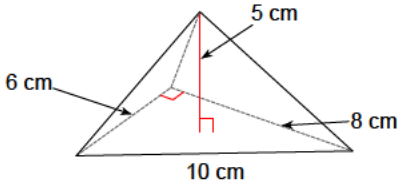

564)

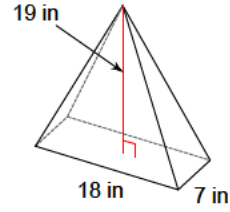

565)

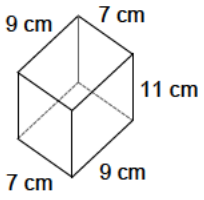

566)

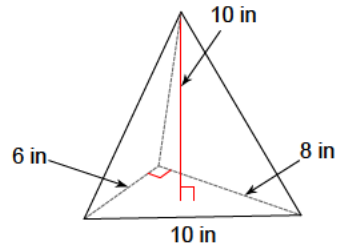

567)

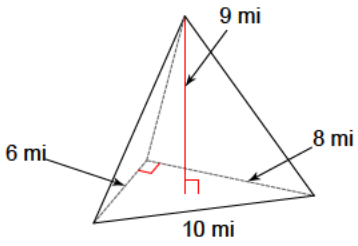

568)

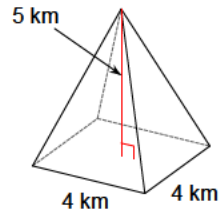

569)

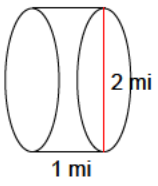

570)

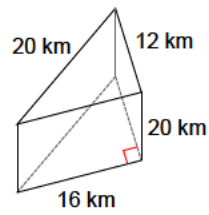

571)

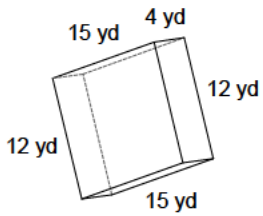

572)

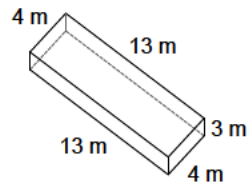

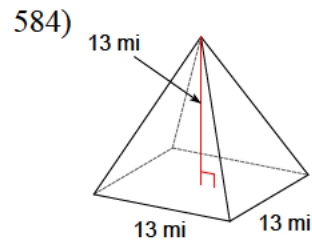
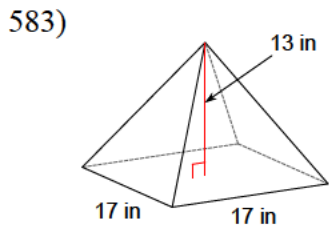
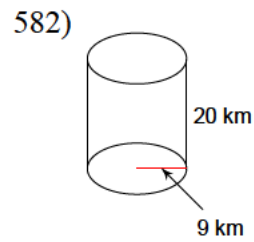
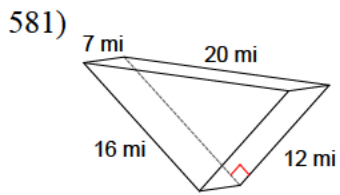
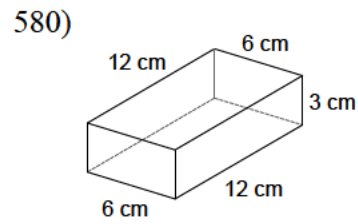
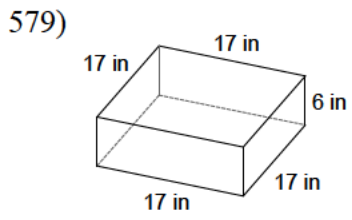
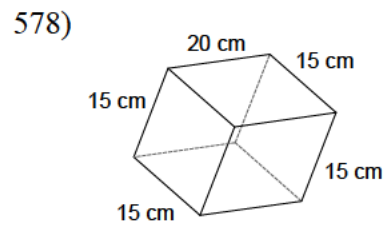
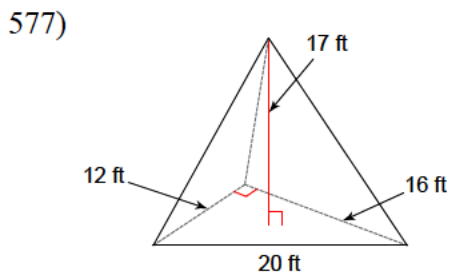
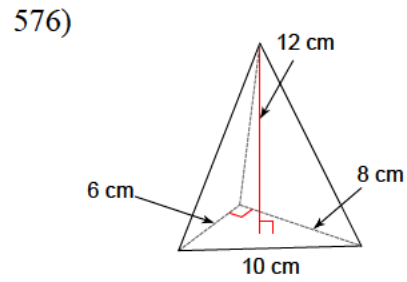
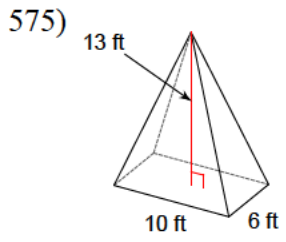
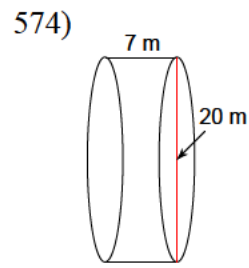
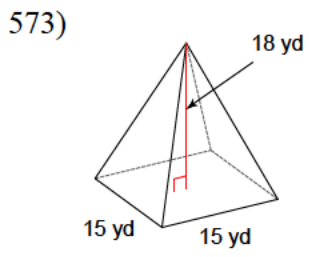

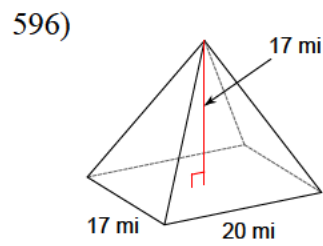
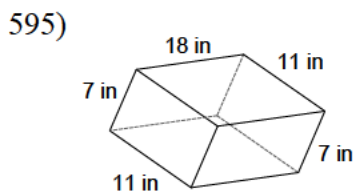
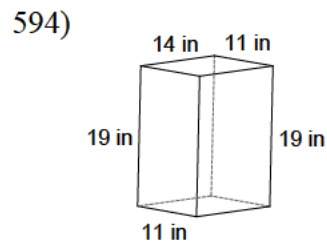
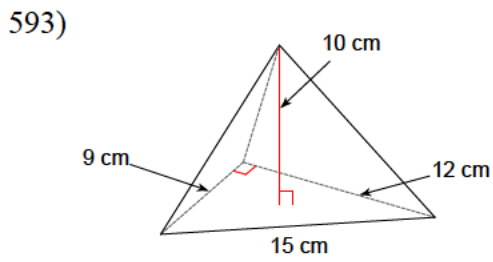
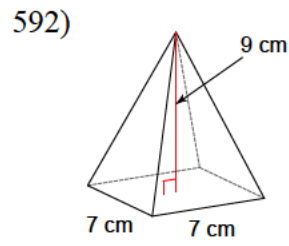
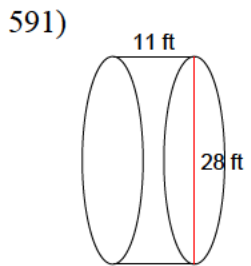
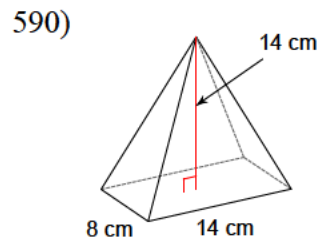
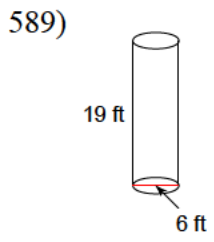
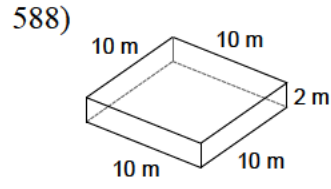
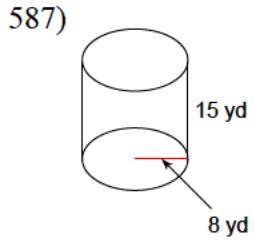
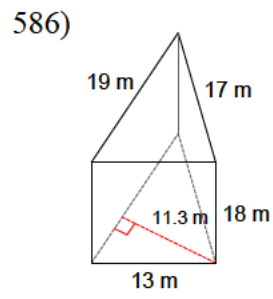
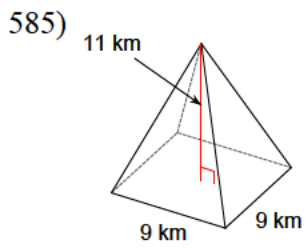

597)

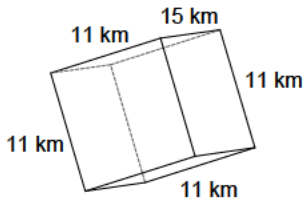

598)

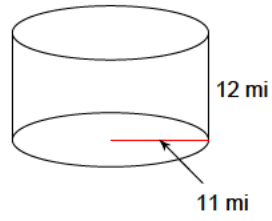

599)

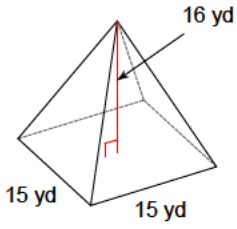

600)

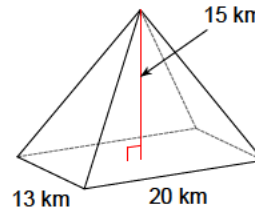

Find the volume of each prism, pyramid, cylinder or cone:

601)

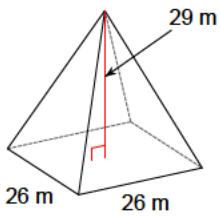

602)

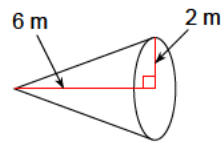

603)

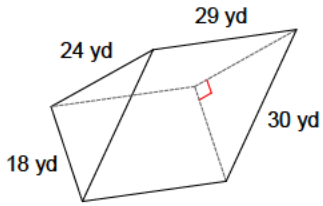

604)

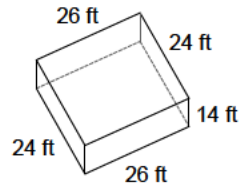

605)

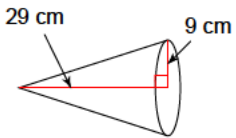

606)

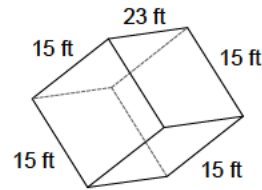

607)

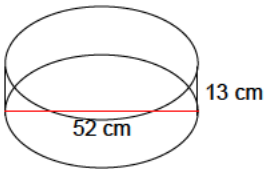

608)

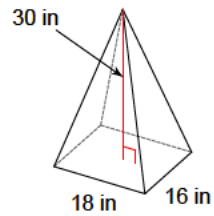

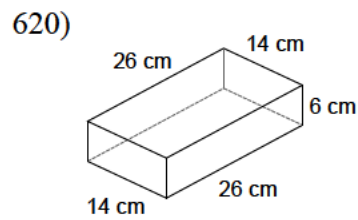
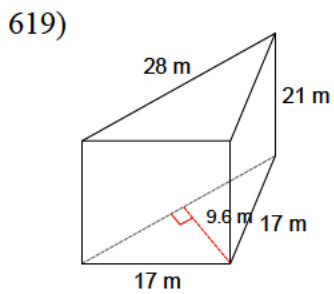
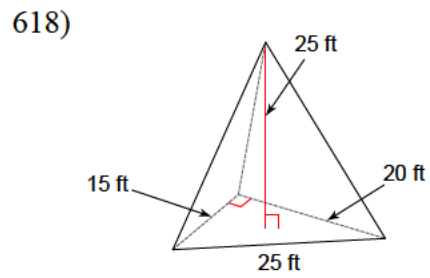
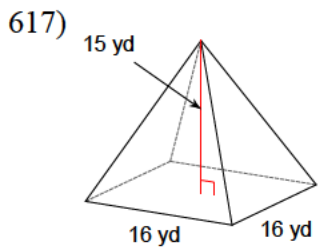
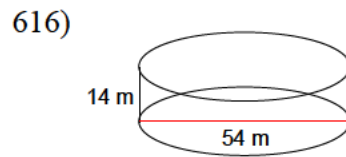
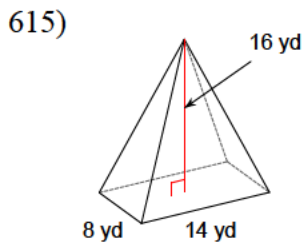
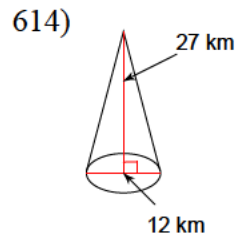
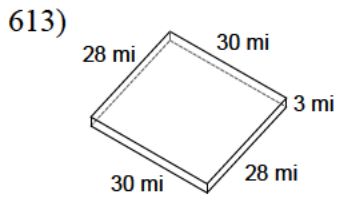
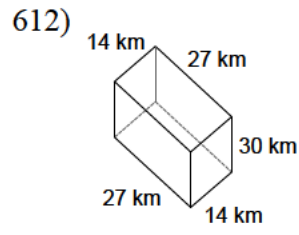
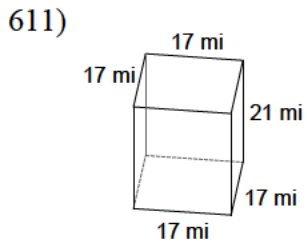
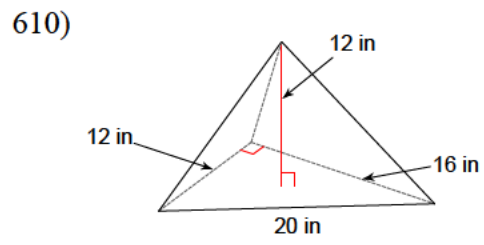
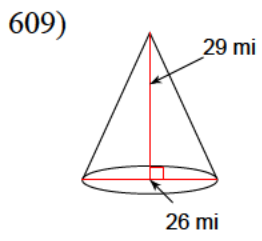

621)

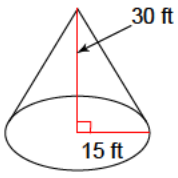

622)

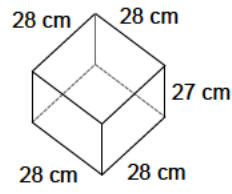

623)

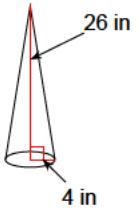

624)

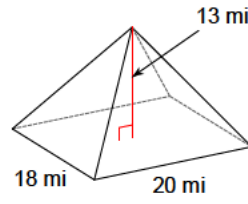

625)

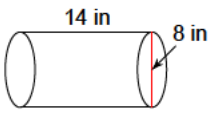

626)

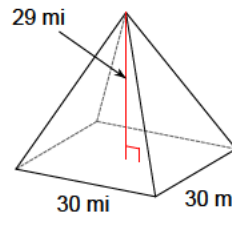

627)

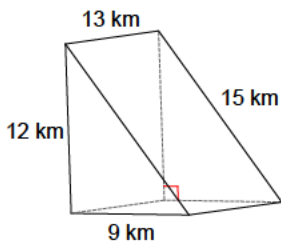

628)

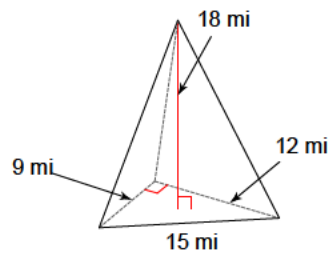

629)

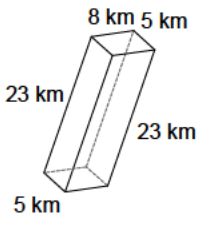

630)

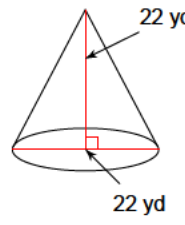

631)

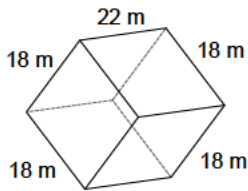

632)

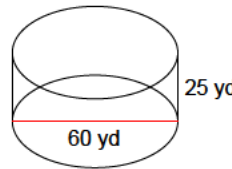

633)

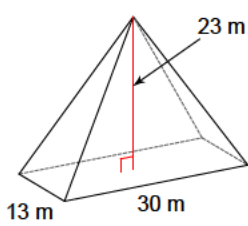

634)

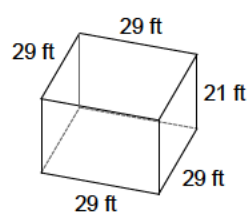

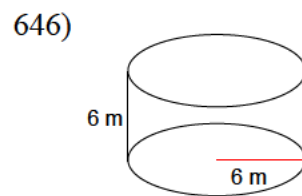
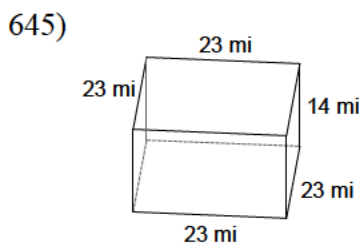
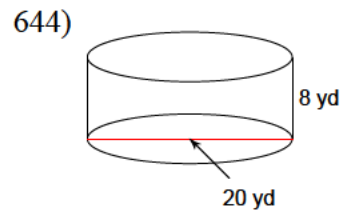
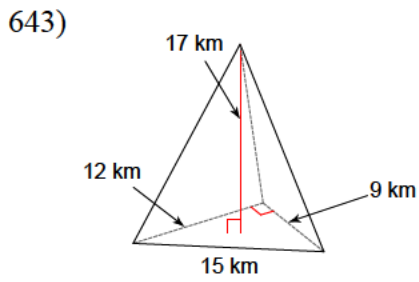
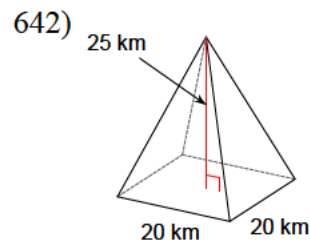
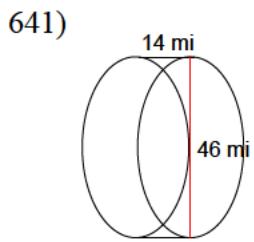
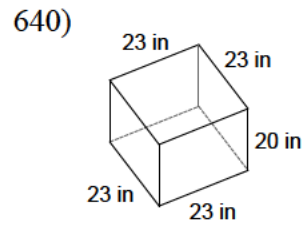
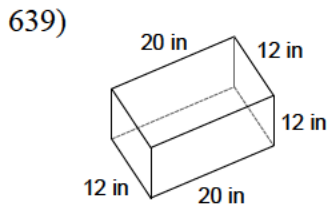
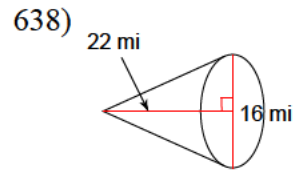
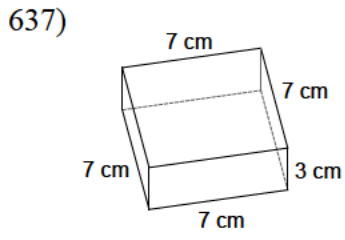
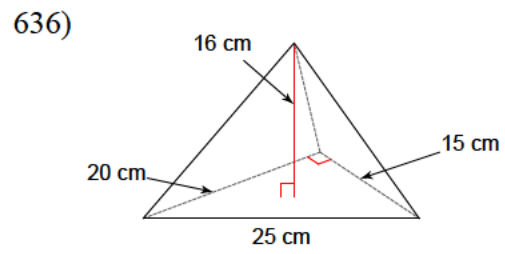
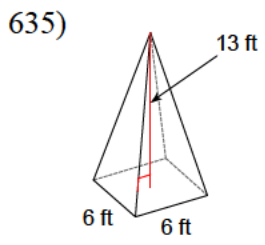

647)

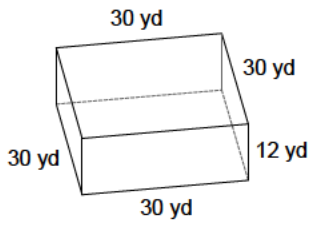

648)

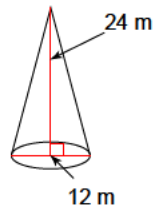

649)

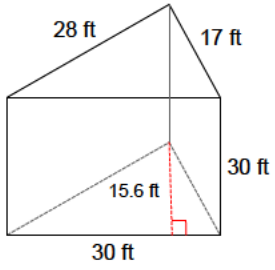

650)

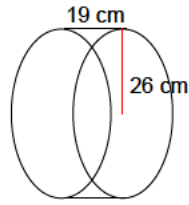

651)

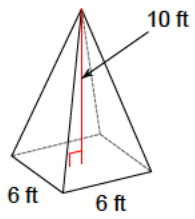

652)

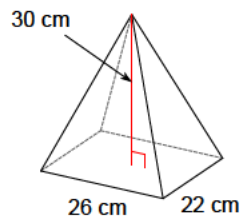

653)

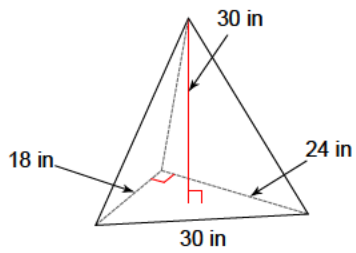

654)

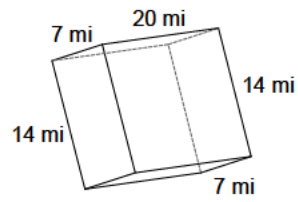

655)

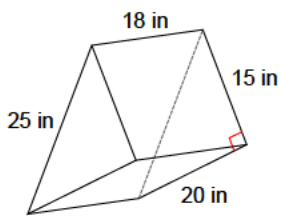

656)

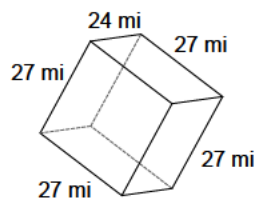

657)

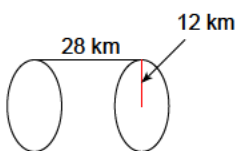

658)

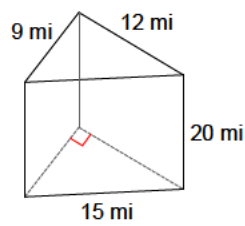

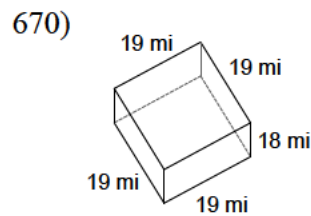
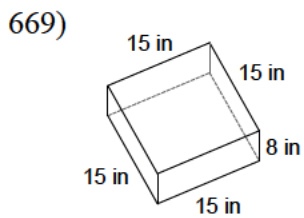
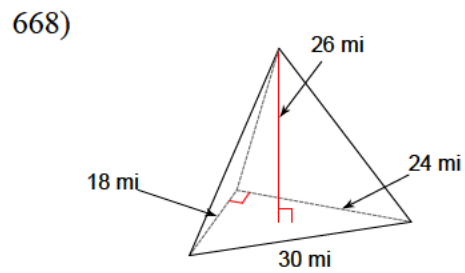
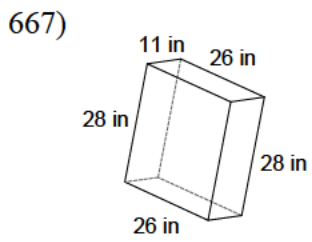
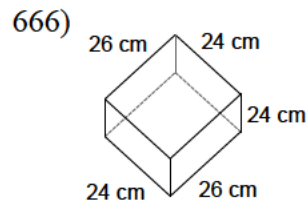
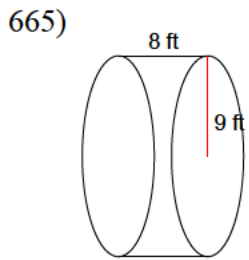
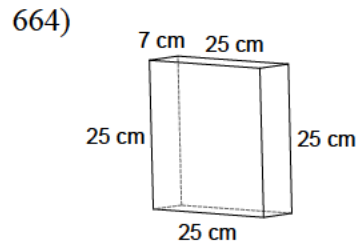
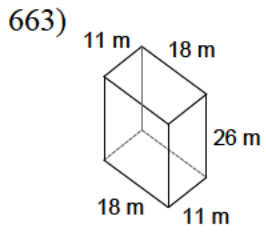
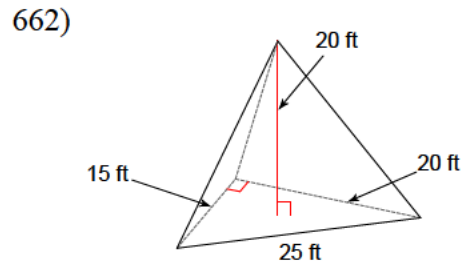
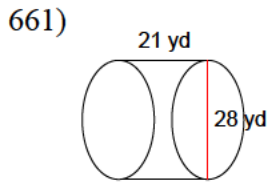
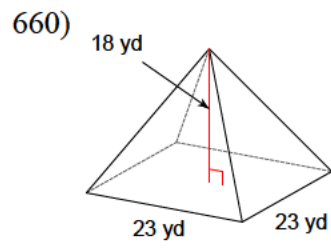
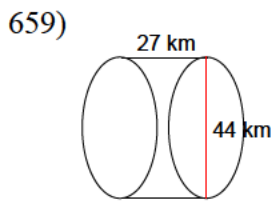

671)

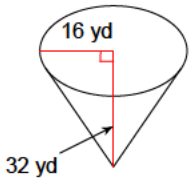

672)

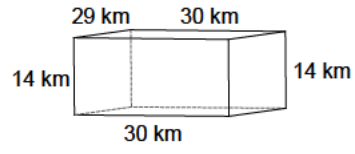

673)

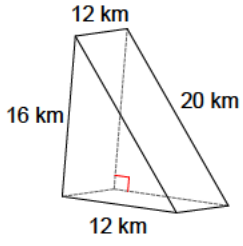

674)

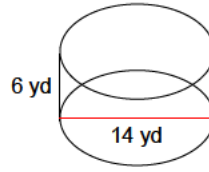

675)

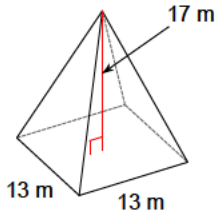

676)

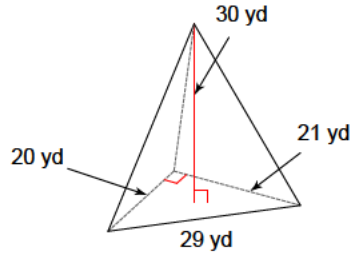

677)

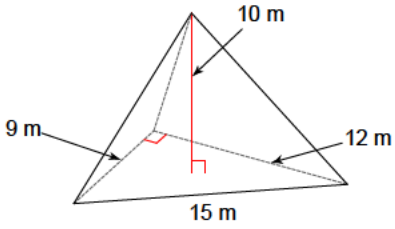

678)

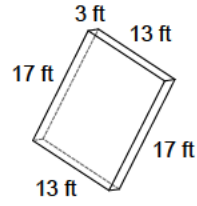

679)

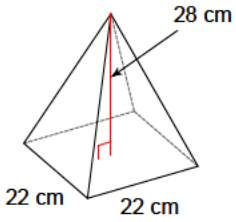

680)

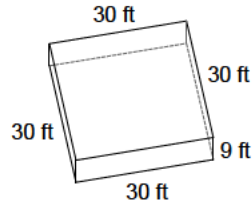

681)

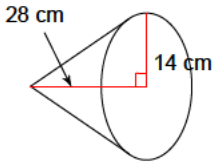

682)

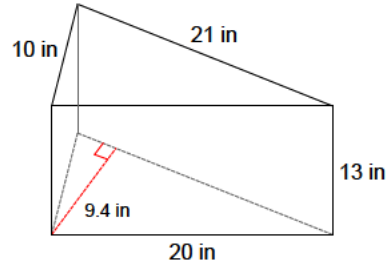

683)

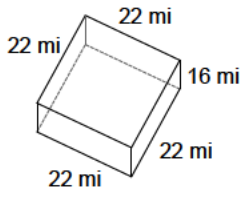

684)

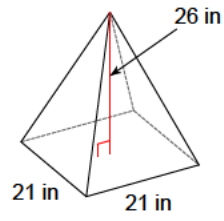

685)

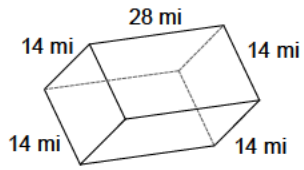

686)

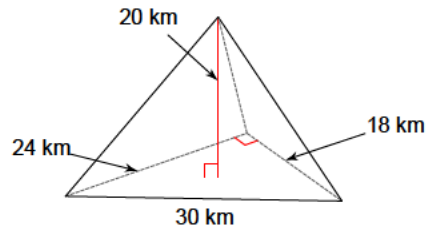

687)

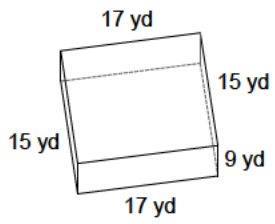

688)

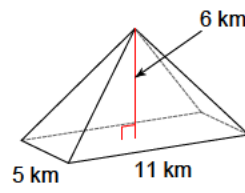

689)

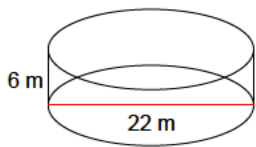

690)

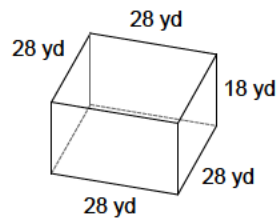

691)

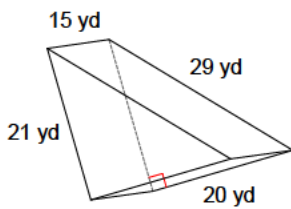

692)

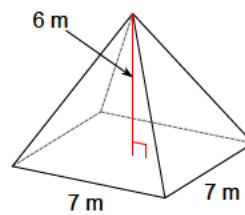

693)

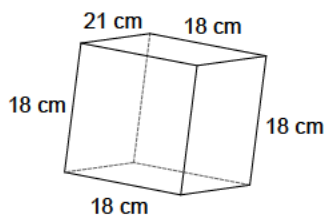

694)

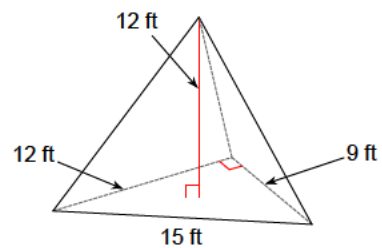

695)

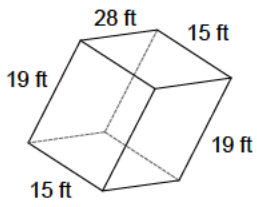

696)

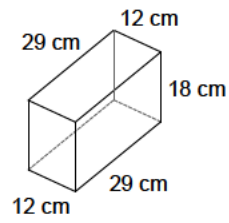

697)

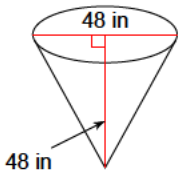

698)

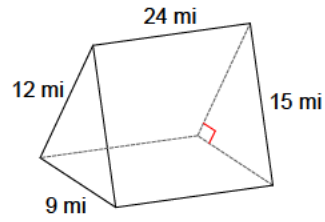

699)

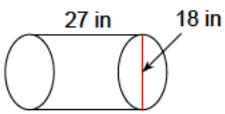

700)

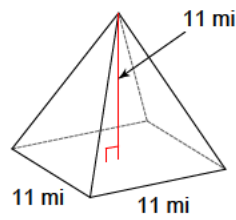

Find the volume of each prism, pyramid, cylinder, cone or sphere:

701)

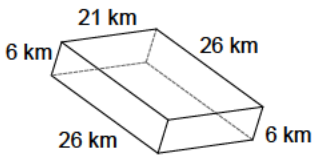

702)

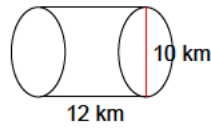

703)

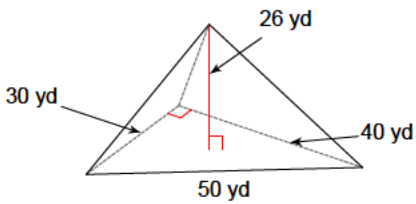

704)

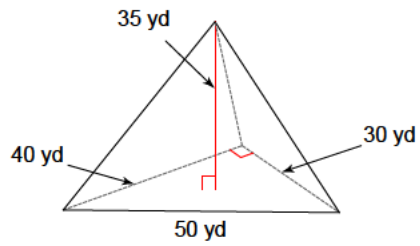

705)

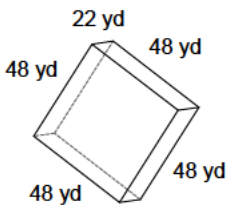

706)

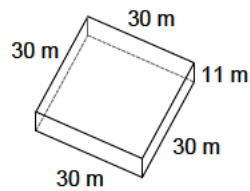

707)

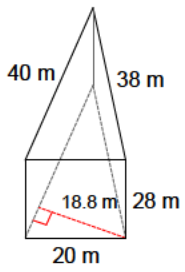

708)

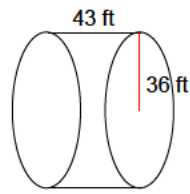

709)

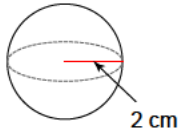

710)

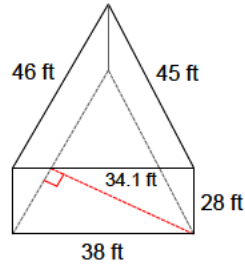

711)

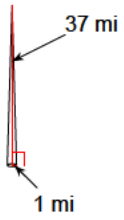

712)

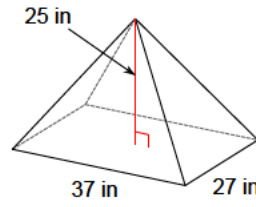

713)

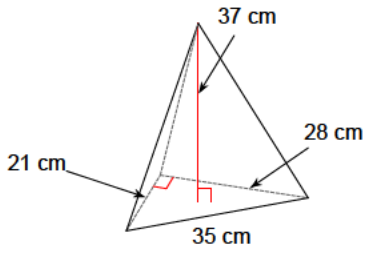

714)

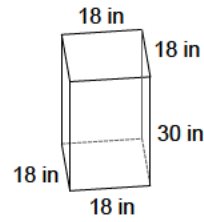

715)

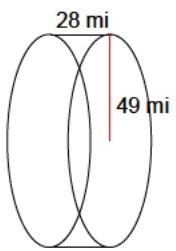

716)

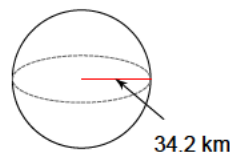

717)

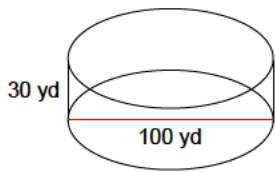

718)

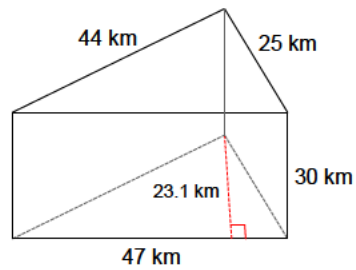

719)

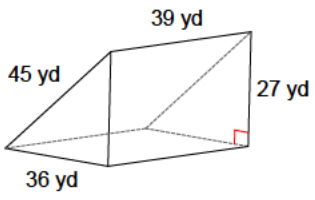

720)

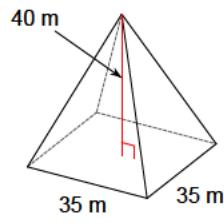

721)

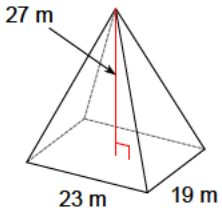

722)

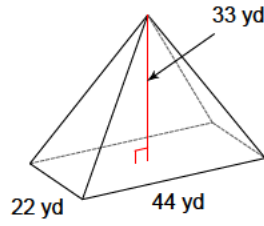

723)

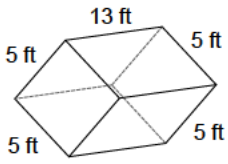

724)

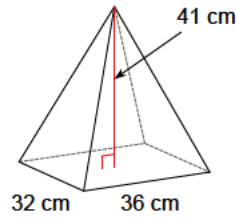

725)

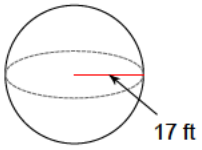

726)

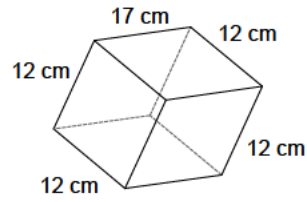

727)

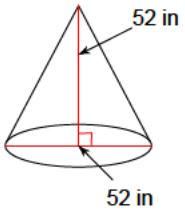

728)

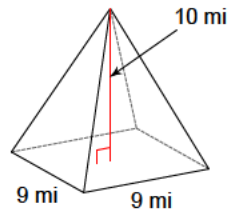

729)

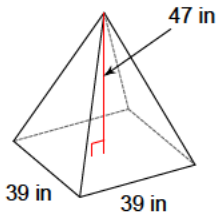

730)

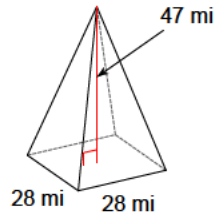

731)

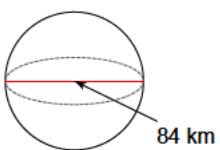

732)

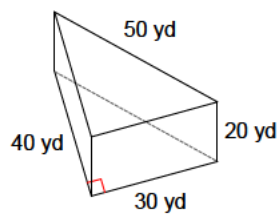

733)

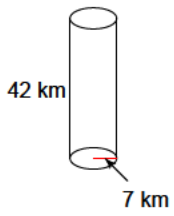

734)

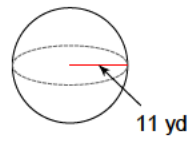

735)

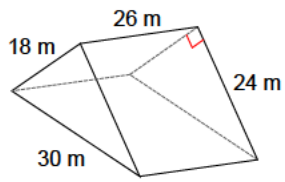

736)

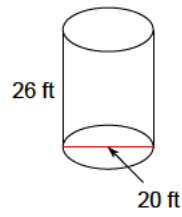

737)

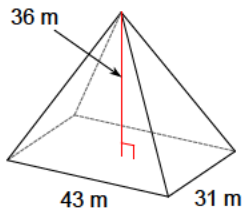

738)

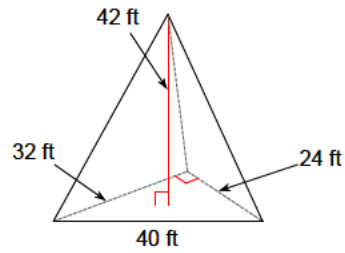

739)

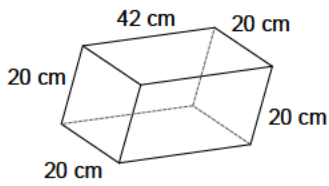

740)

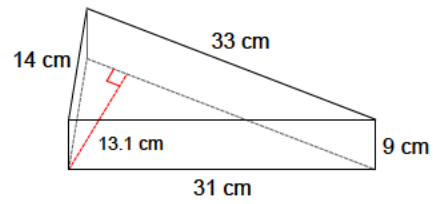

741)

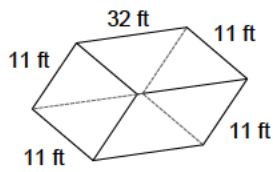

742)

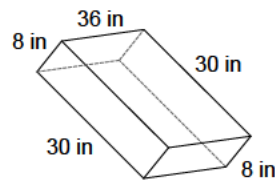

743)

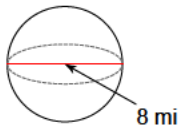

744)

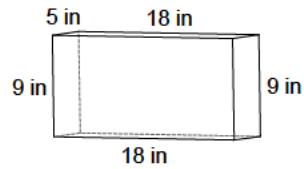

745)

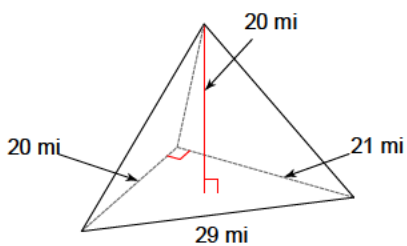

746)

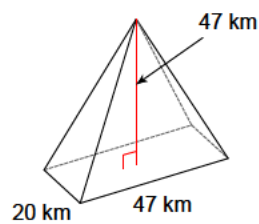

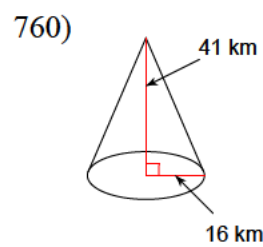
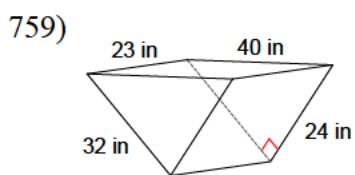
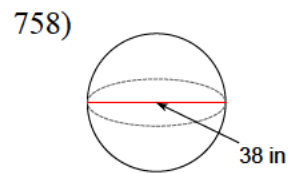
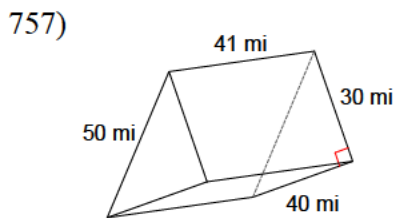
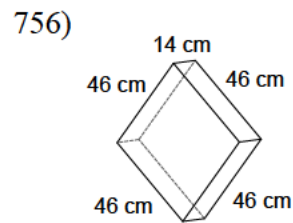
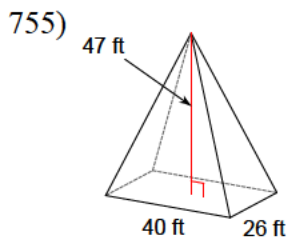
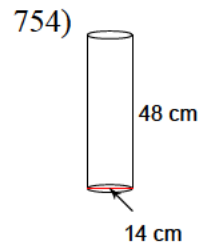
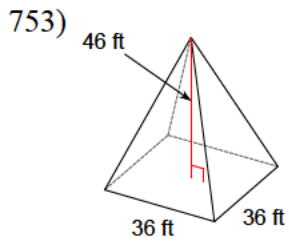
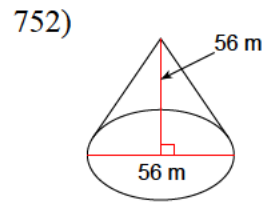
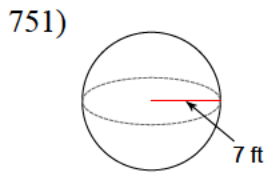
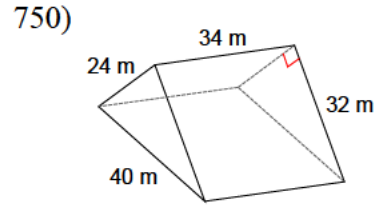
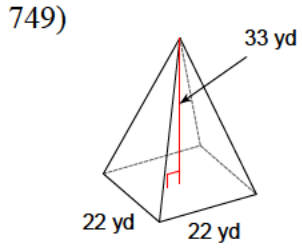
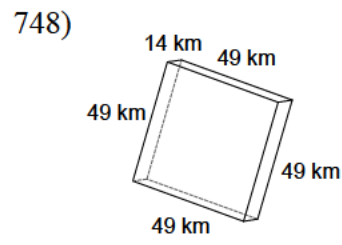
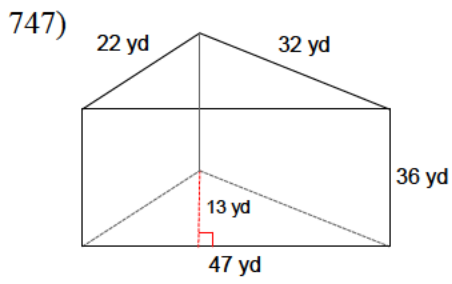

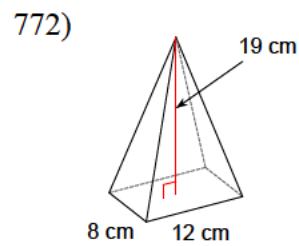
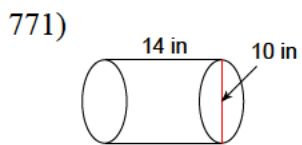
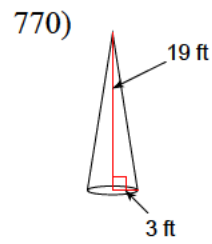
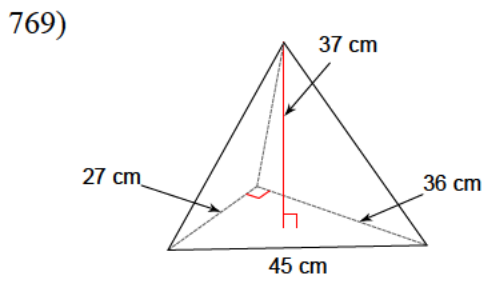
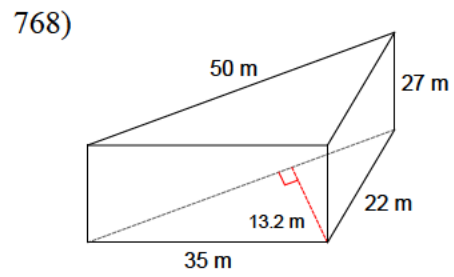
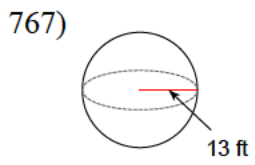
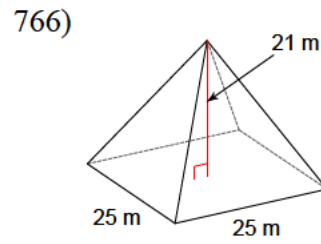
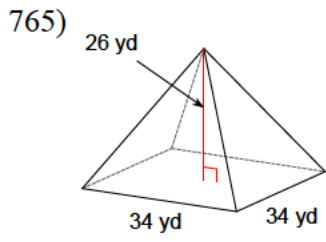
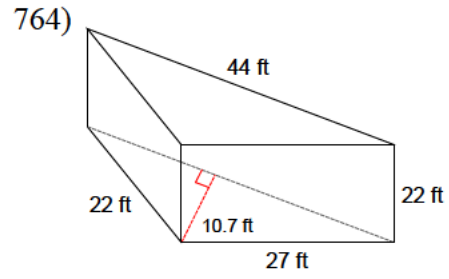
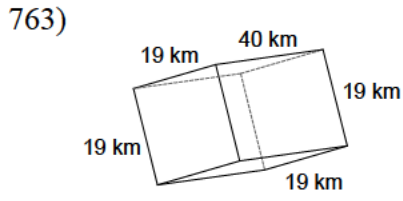
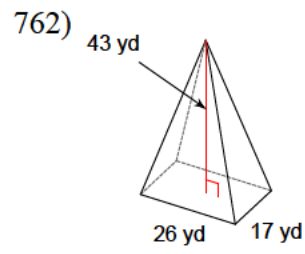
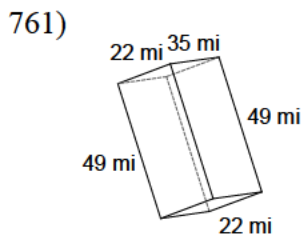

773)

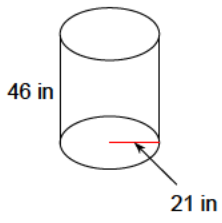

774)

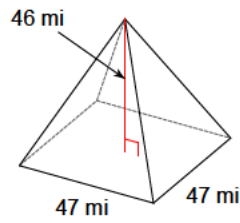

775)

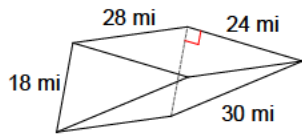

776)

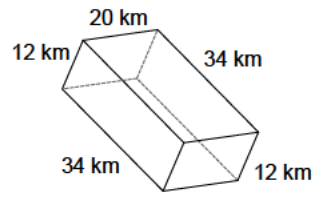

777)

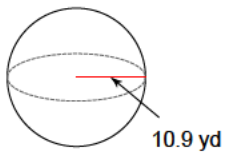

778)

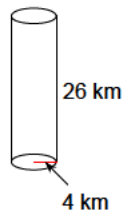

779)

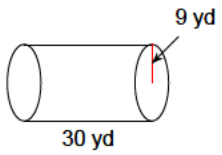

780)

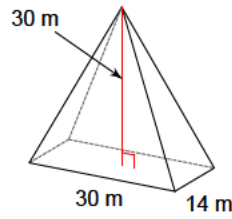

781)

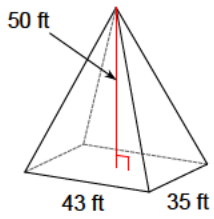

782)

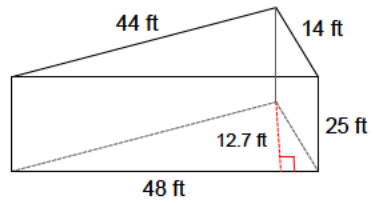

783)

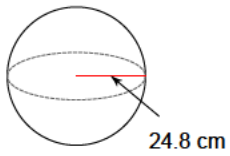

784)

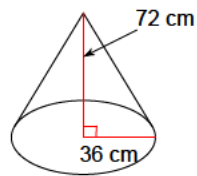

785)

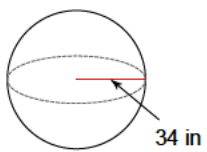

786)

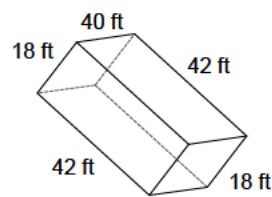

787)

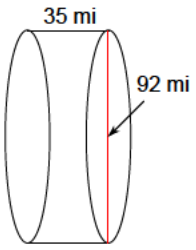

788)

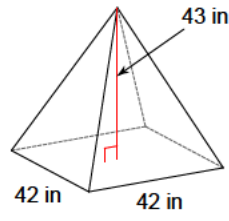

789)

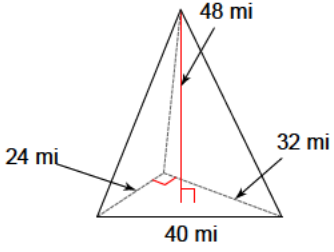

790)

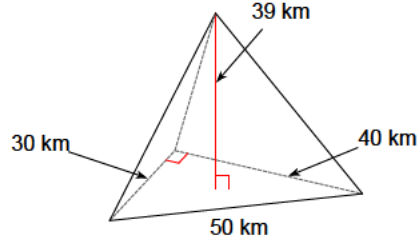

791)

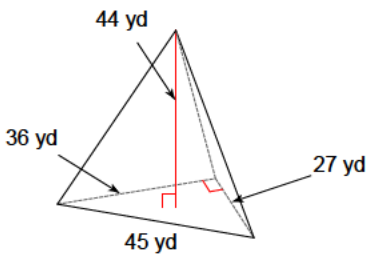

792)

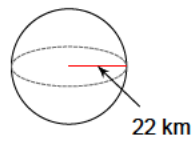

793)

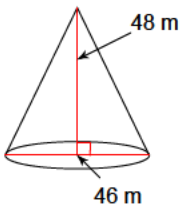

794)

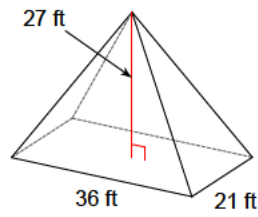

795)

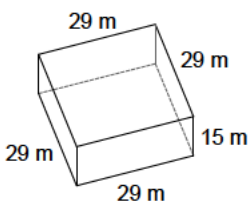

796)

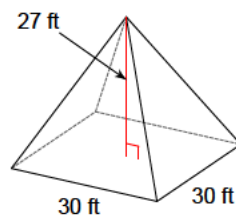

797)

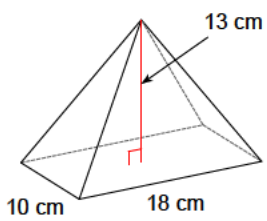

798)

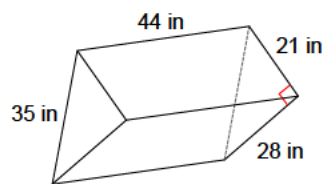

799)

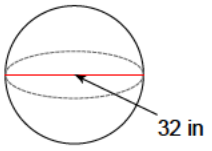

800)

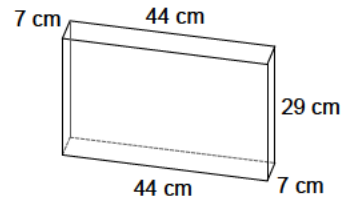

Find the volume of prism, pyramid, cylinder, cone or sphere

Find the volume of each prism:

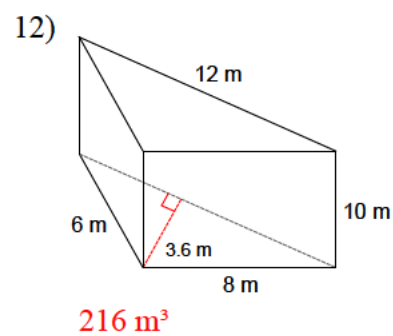
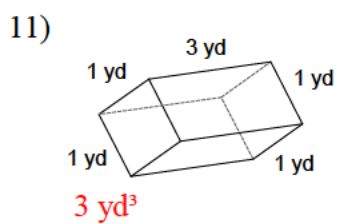
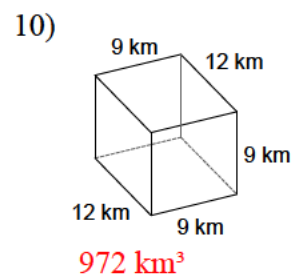
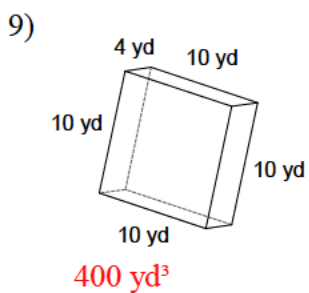
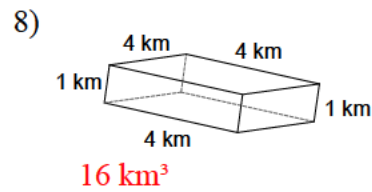
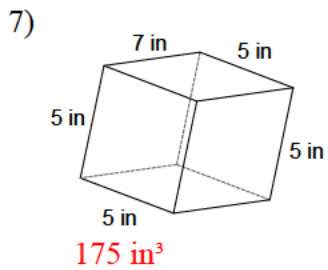
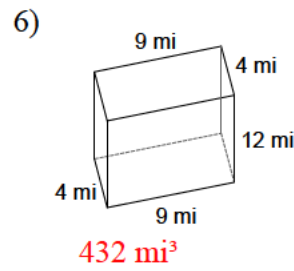
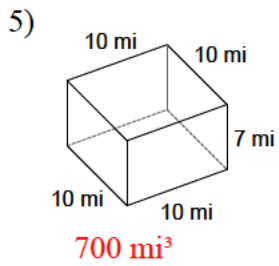
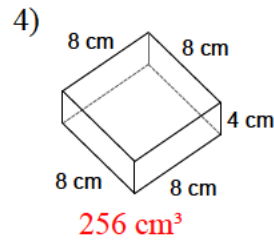
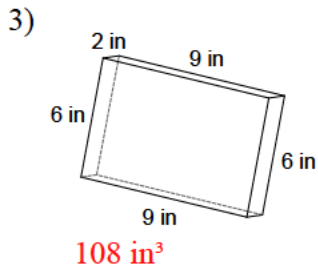
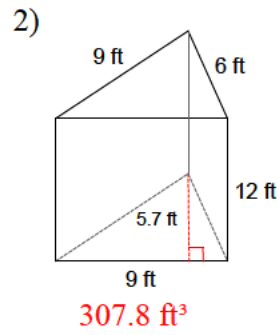
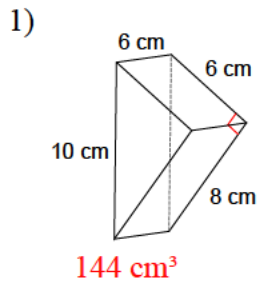

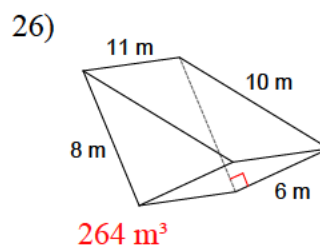
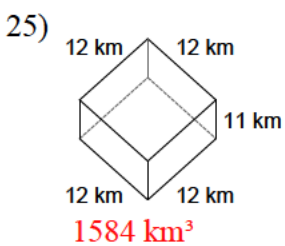
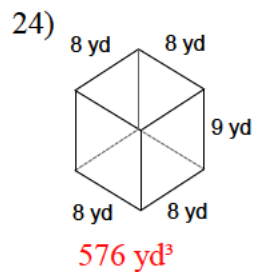
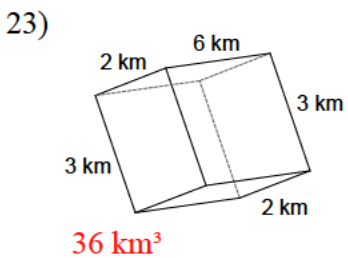
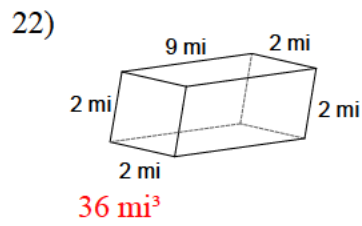
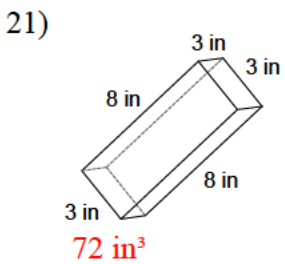
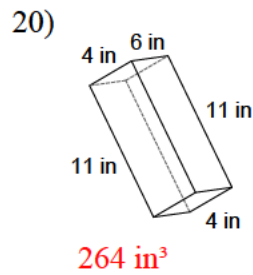
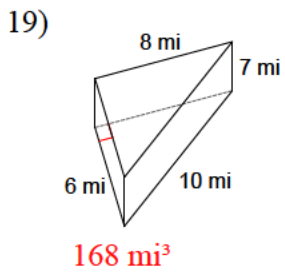
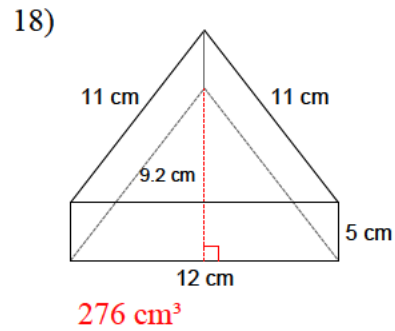
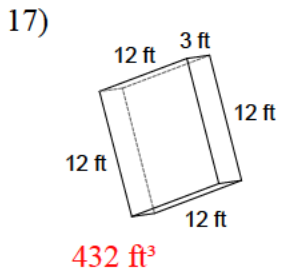
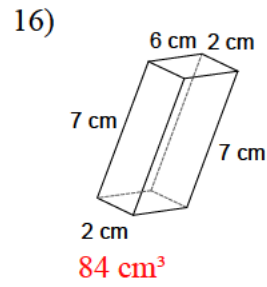
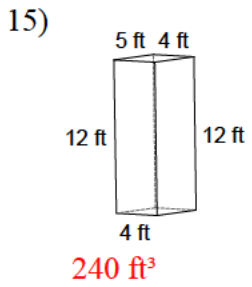
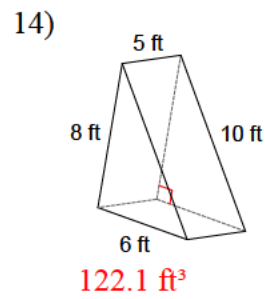
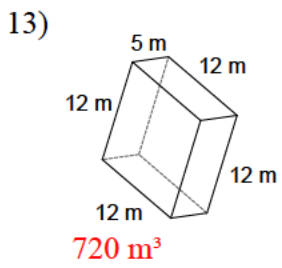

27)

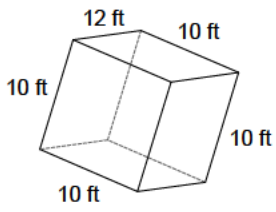

1200 ft^3

28)

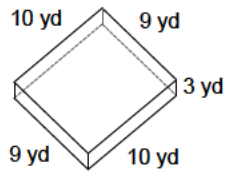

270 yd^3

29)

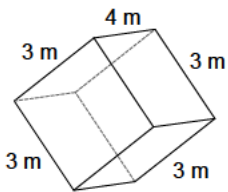

36 m^3

30)

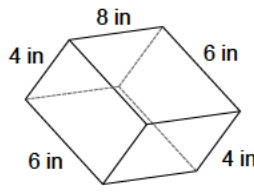

192 in^3

31)

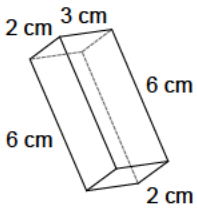

36 cm^3

32)

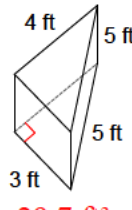

29.7 ft^3

33)

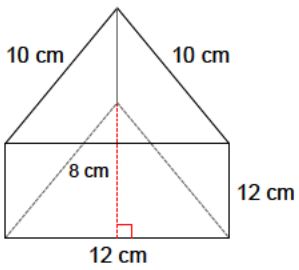

576 cm^3

34)

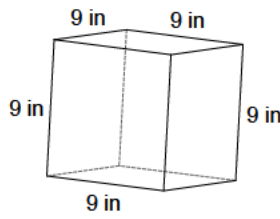

729 in^3

35)

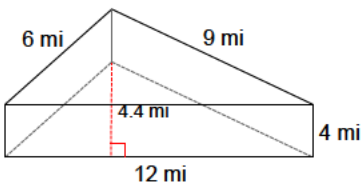

105.6 mi^3

36)

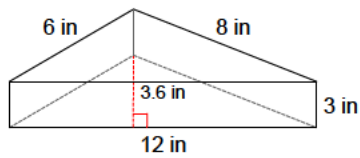

64.8 in^3

37)

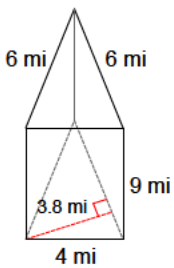

102.6 mi^3

38)

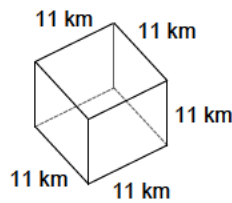

1331 km^3

39)

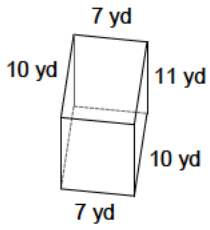

770 yd^3

40)

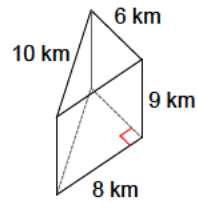

216 km^3

41)

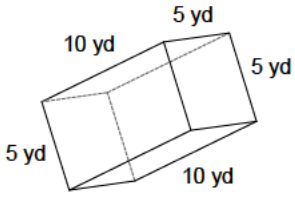

250 yd^3

42)

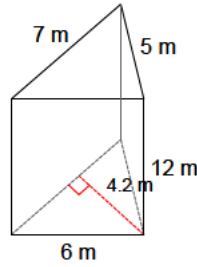

176.4 m^3

43)

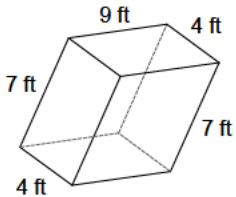

252 ft^3

44)

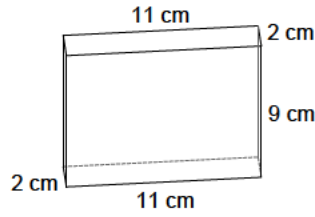

198 cm^3

45)

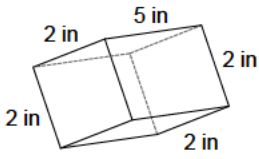

20 in^3

46)

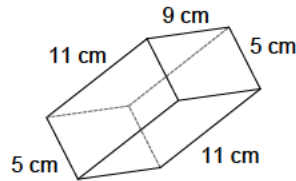

495 cm^3

47)

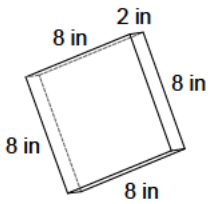

128 in^3

48)

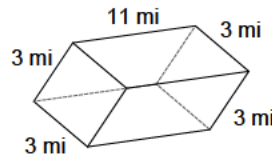

99 mi^3

49)

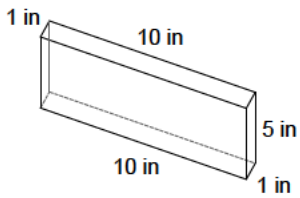

50 in^3

50)

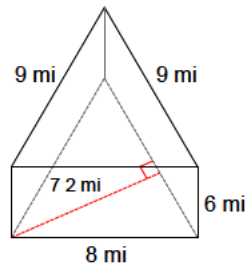

194.4 mi^3

51)

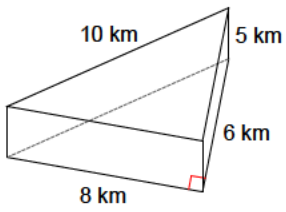

$$120 \text{ km}^3$$

52)

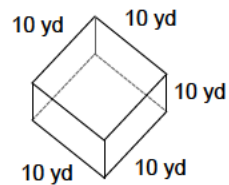

$$1000 \text{ yd}^3$$

53)

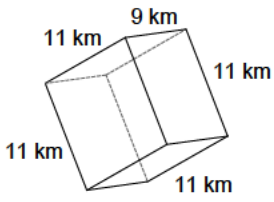

$$1089 \text{ km}^3$$

54)

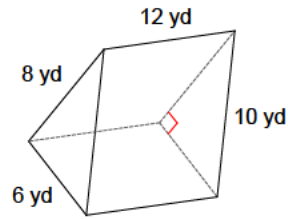

$$288 \text{ yd}^3$$

55)

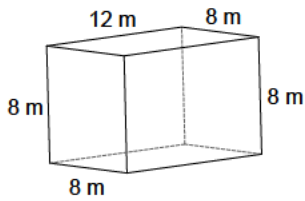

$$768 \text{ m}^3$$

56)

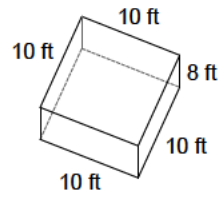

$$800 \text{ ft}^3$$

57)

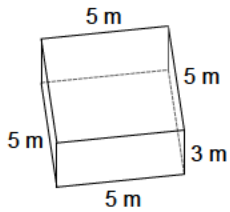

$$75 \text{ m}^3$$

58)

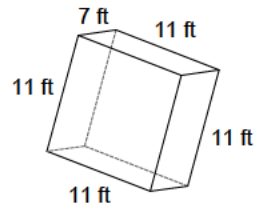

$$847 \text{ ft}^3$$

59)

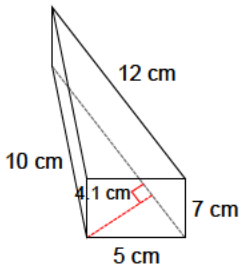

$$172.2 \text{ cm}^3$$

60)

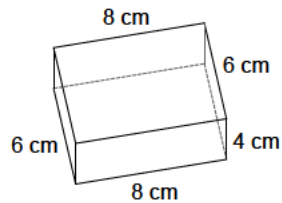

$$192 \text{ cm}^3$$

61)

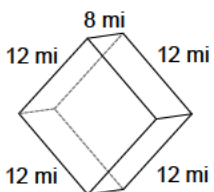

$$1152 \text{ mi}^3$$

62)

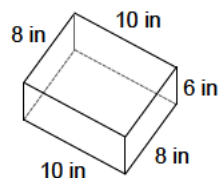

$$480 \text{ in}^3$$

63)

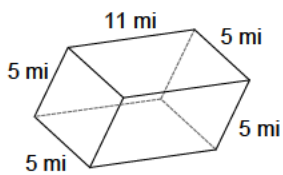

$$275 \text{ mi}^3$$

64)

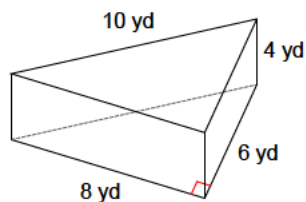

$$96 \text{ yd}^3$$

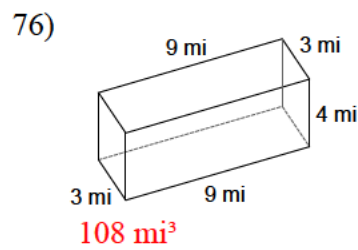
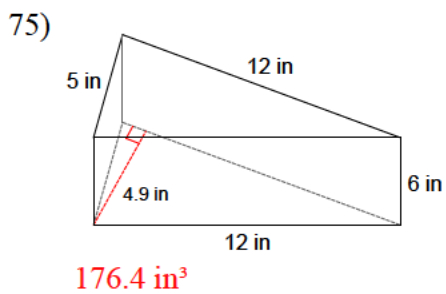
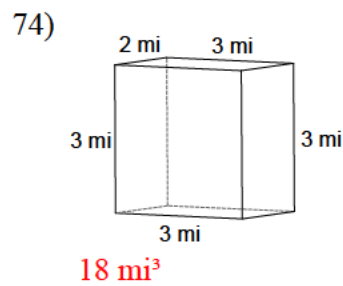
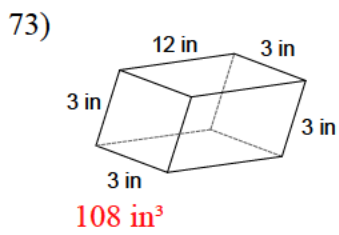
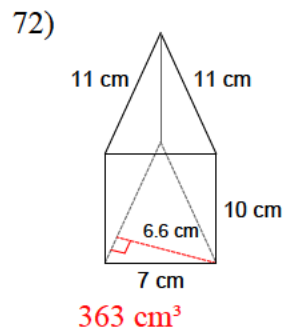
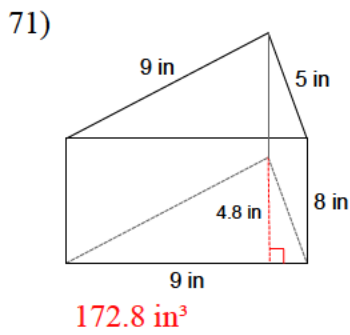
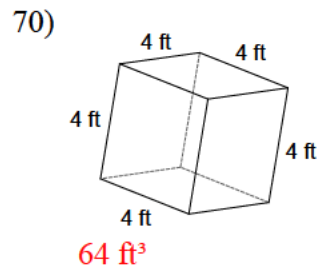
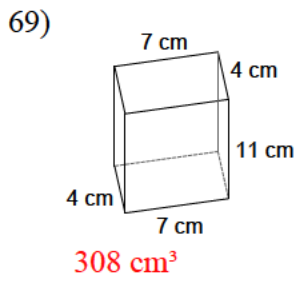
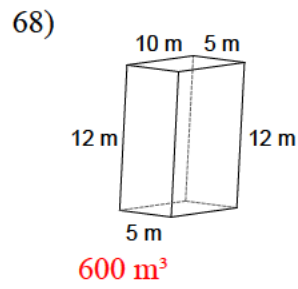
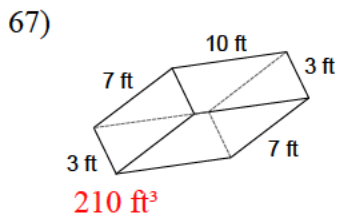
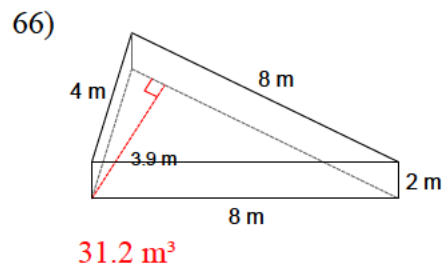
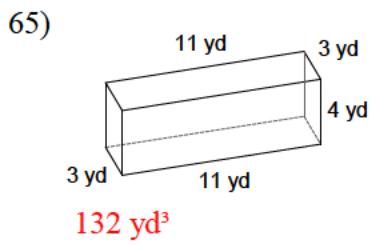

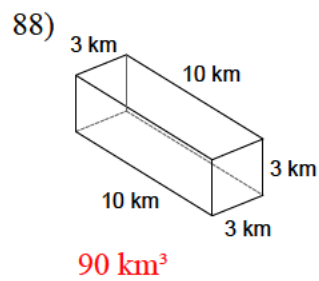
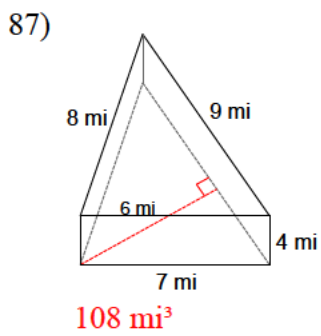
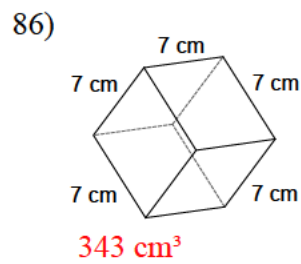
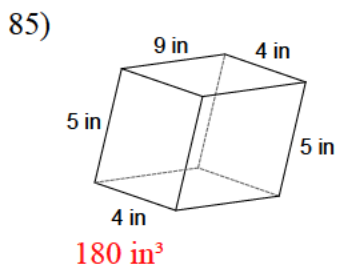
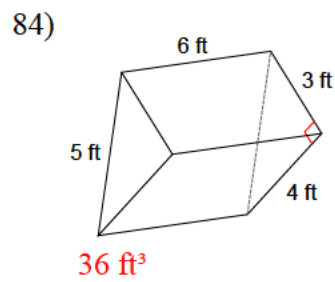
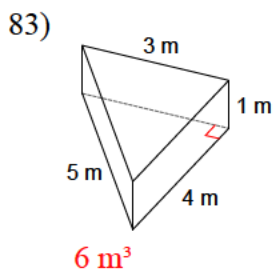
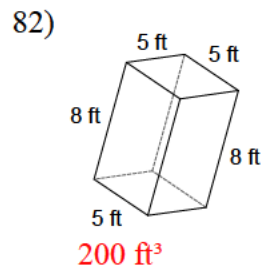
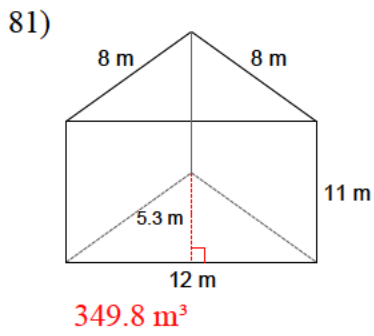
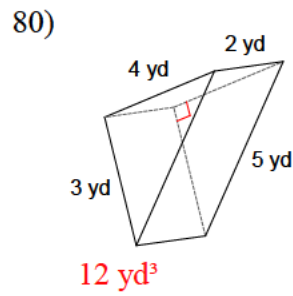
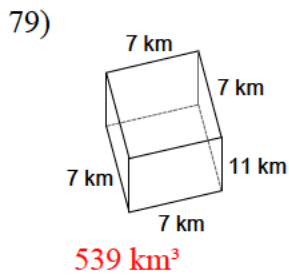
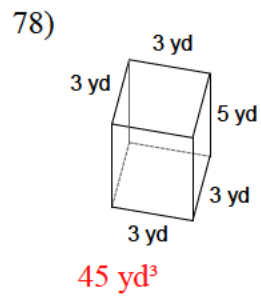
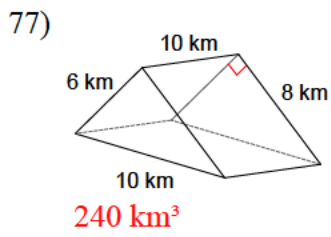

89)

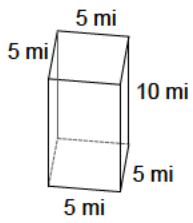

$$250 \text{ mi}^3$$

90)

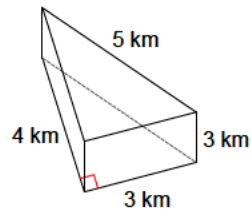

$$18 \text{ km}^3$$

91)

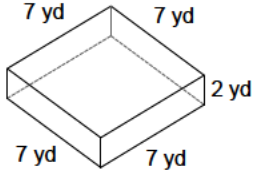

$$98 \text{ yd}^3$$

92)

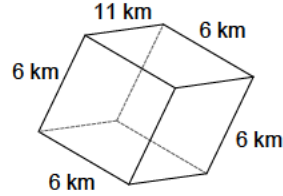

$$396 \text{ km}^3$$

93)

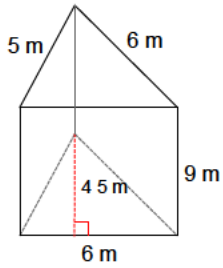

$$121.5 \text{ m}^3$$

94)

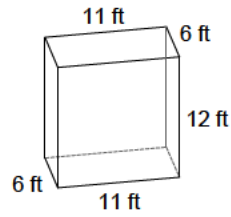

$$792 \text{ ft}^3$$

95)

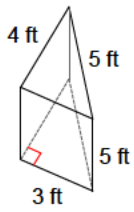

$$30 \text{ ft}^3$$

96)

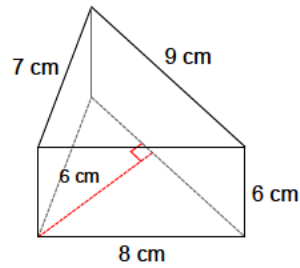

$$162 \text{ cm}^3$$

97)

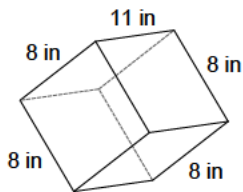

$$704 \text{ in}^3$$

98)

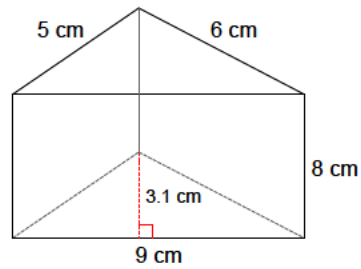

$$111.6 \text{ cm}^3$$

99)

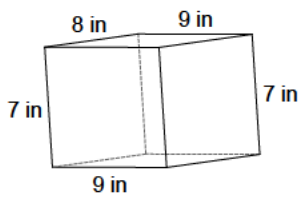

$$504 \text{ in}^3$$

100)

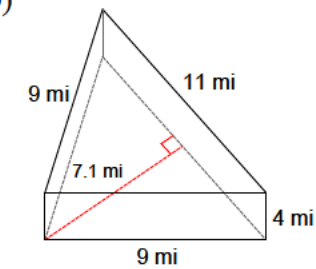

$$156.2 \text{ mi}^3$$

101)

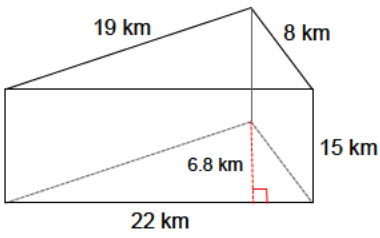

1122 km^3

102)

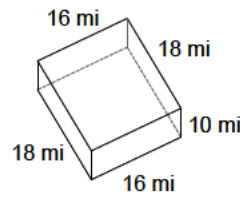

2880 mi^3

103)

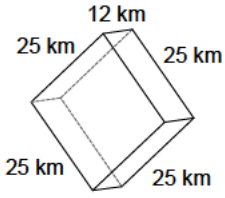

7500 km^3

104)

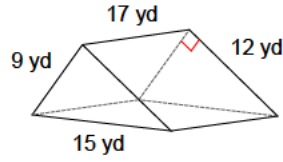

918 yd^3

105)

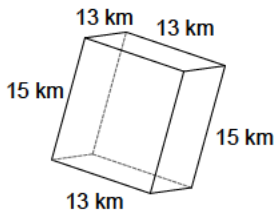

2535 km^3

106)

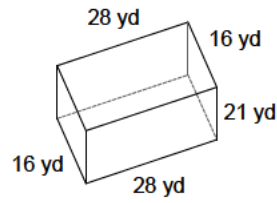

9408 yd^3

107)

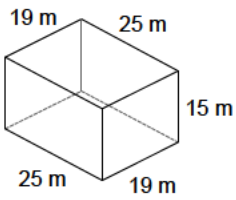

7125 m^3

108)

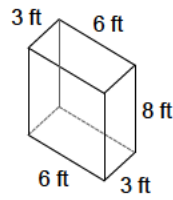

144 ft^3

109)

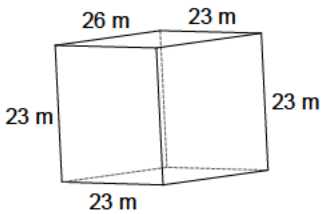

13754 m^3

110)

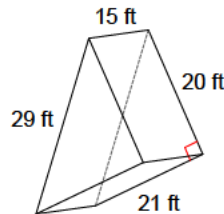

3150 ft^3

111)

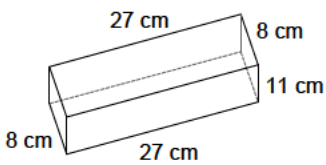

2376 cm^3

112)

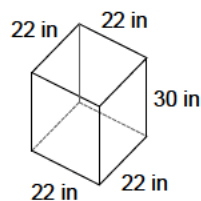

14520 in^3

113)

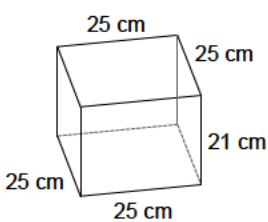

13125 cm^3

114)

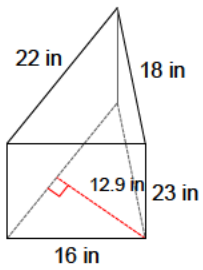

3263.7 in^3

115)

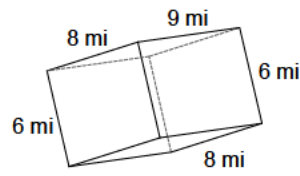

432 mi^3

116)

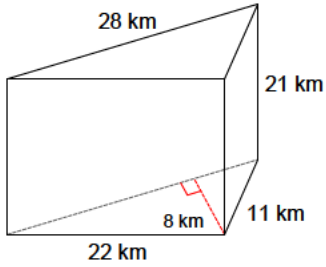

2352 km^3

117)

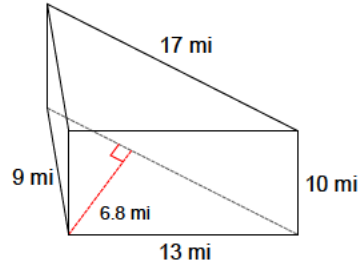

578 mi^3

118)

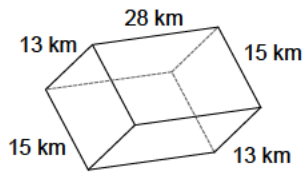

5460 km^3

119)

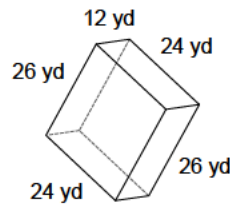

7488 yd^3

120)

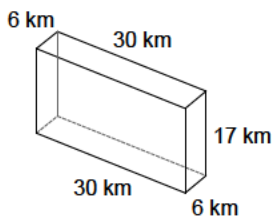

3060 km^3

121)

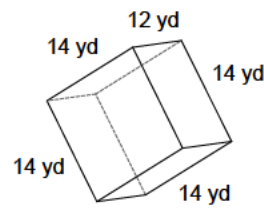

2352 yd^3

122)

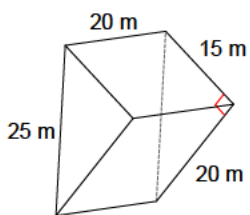

3000 m^3

123)

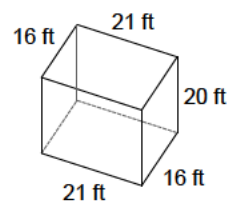

6720 ft^3

124)

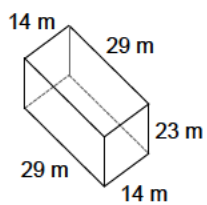

9338 m^3

125)

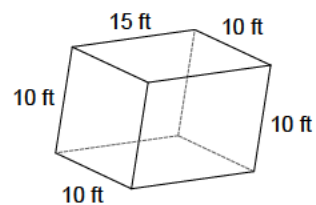

1500 ft^3

126)

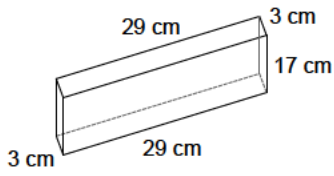

1479 cm^3

127)

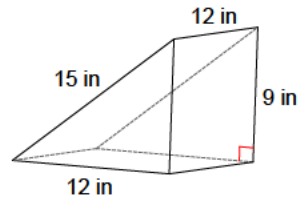

648 in^3

128)

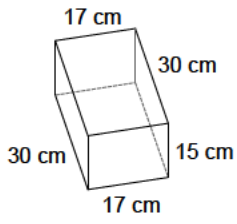

7650 cm^3

129)

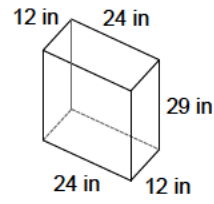

8352 in^3

130)

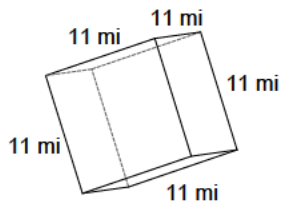

1331 mi^3

131)

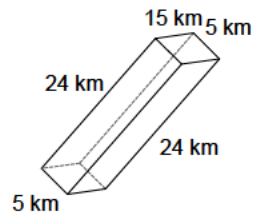

1800 km^3

132)

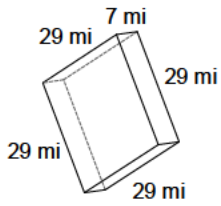

5887 mi^3

133)

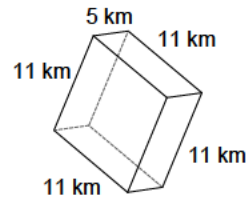

605 km^3

134)

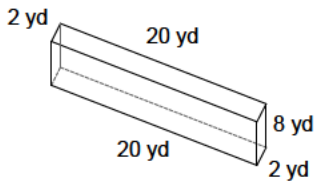

320 yd^3

135)

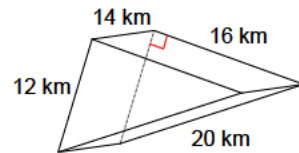

1344 km^3

136)

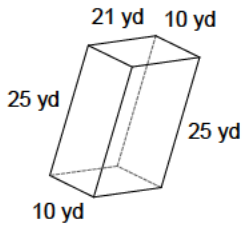

5250 yd^3

137)

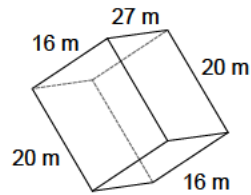

8640 m^3

138)

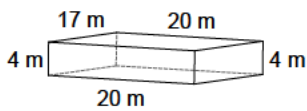

1360 m^3

139)

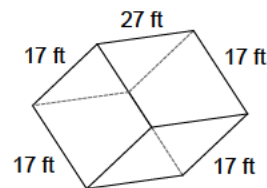

7803 ft^3

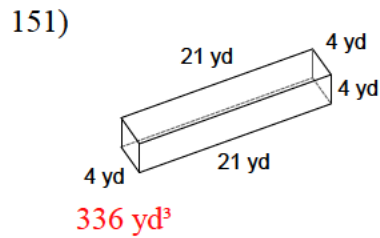
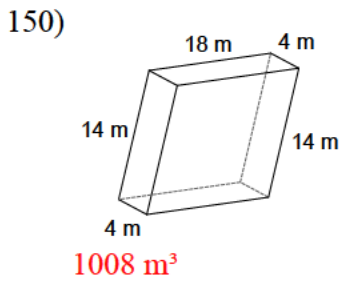
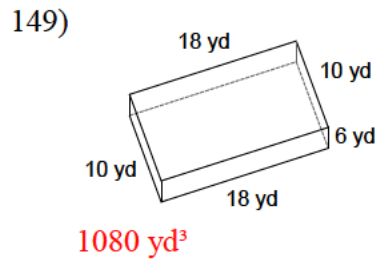
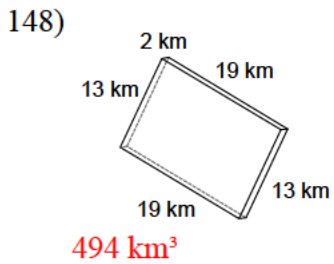
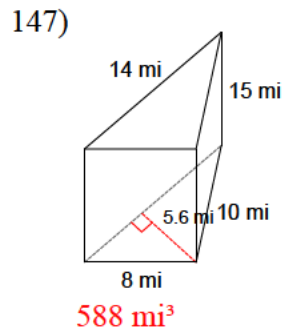
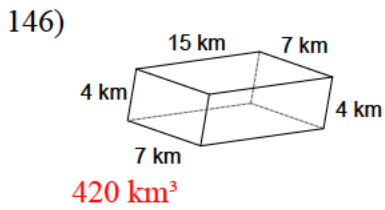
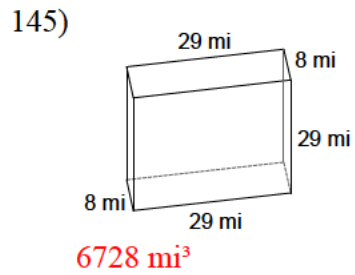
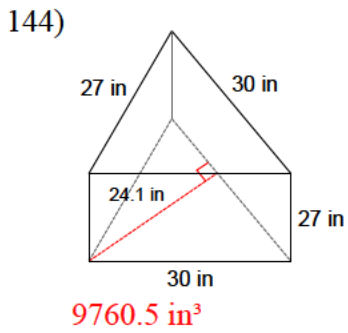
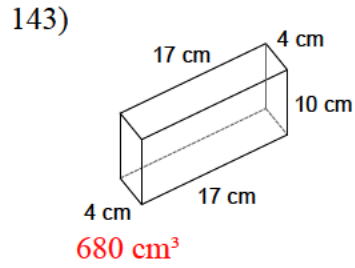
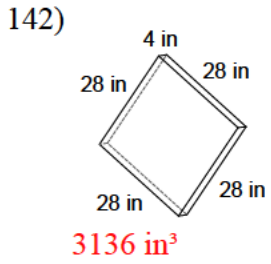
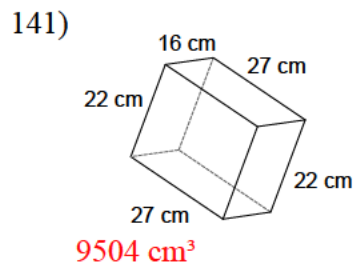
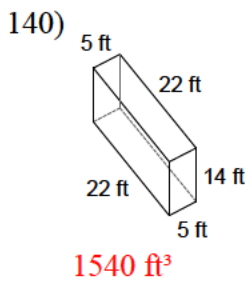

152)

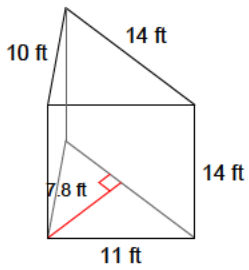

$$764.4 \text{ ft}^3$$

154)

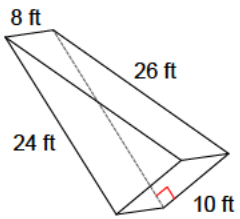

$$961.7 \text{ ft}^3$$

156)

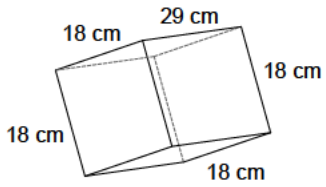

$$9396 \text{ cm}^3$$

158)

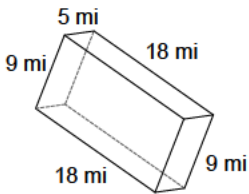

$$810 \text{ mi}^3$$

160)

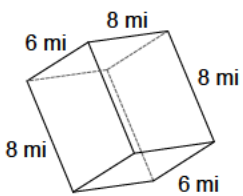

$$384 \text{ mi}^3$$

162)

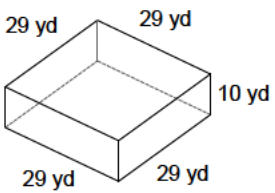

$$8410 \text{ yd}^3$$

153)

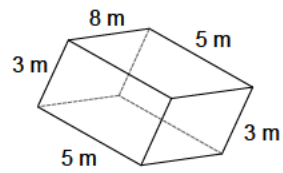

$$120 \text{ m}^3$$

155)

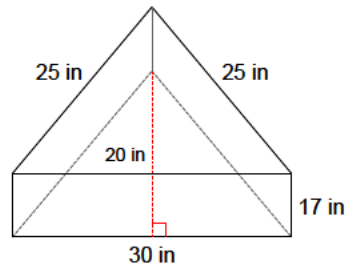

$$5100 \text{ in}^3$$

157)

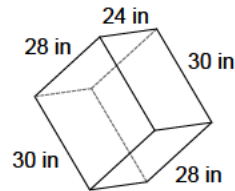

$$20160 \text{ in}^3$$

159)

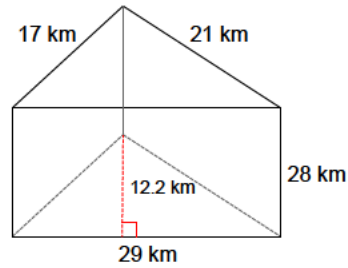

$$4953.2 \text{ km}^3$$

161)

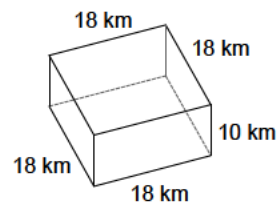

$$3240 \text{ km}^3$$

163)

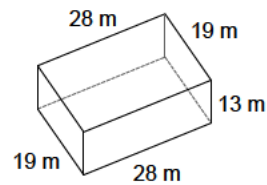

$$6916 \text{ m}^3$$

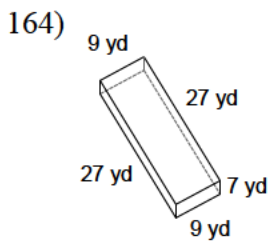

1701 yd^3

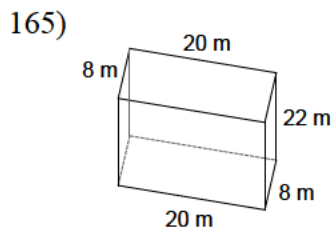

3520 m^3

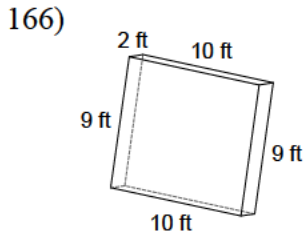

180 ft^3

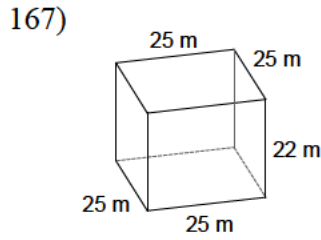

13750 m^3

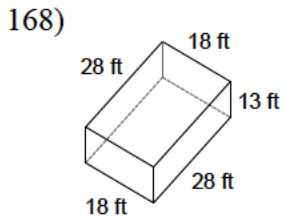

6552 ft^3

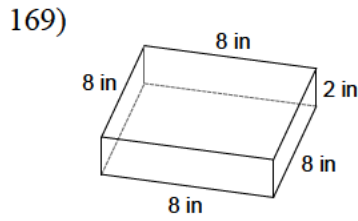

128 in^3

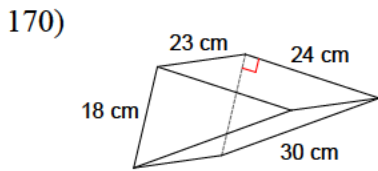

4968 cm^3

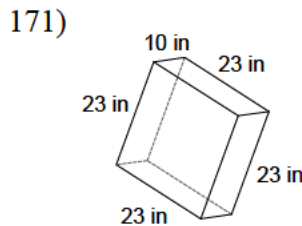

5290 in^3

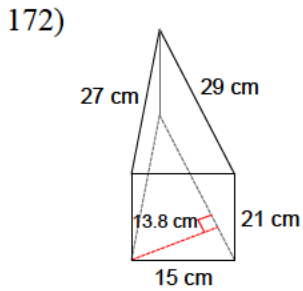

4202.1 cm^3

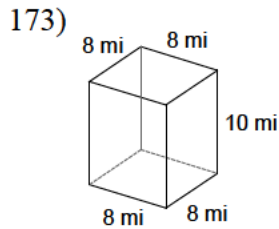

640 mi^3

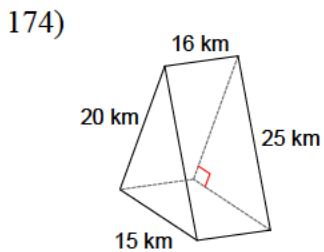

2400 km^3

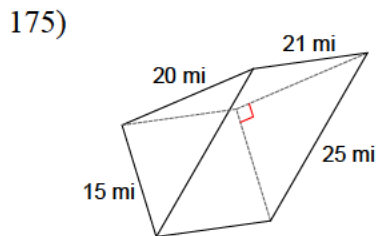

3150 mi^3

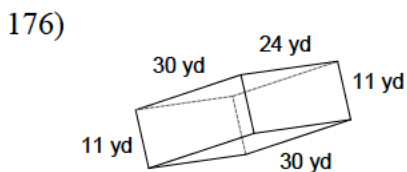

7920 yd^3

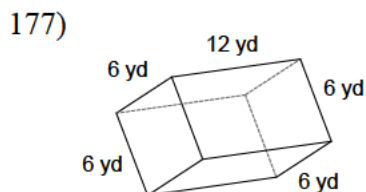

432 yd^3

178)

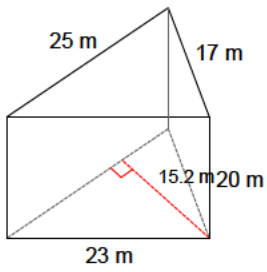

3800 m^3

179)

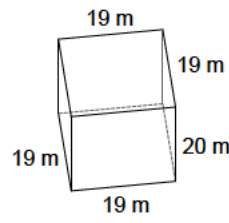

7220 m^3

180)

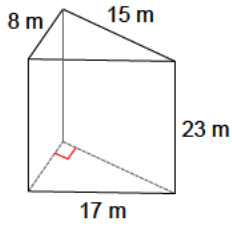

1380 m^3

181)

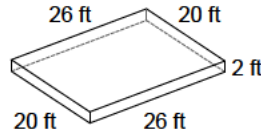

1040 ft^3

182)

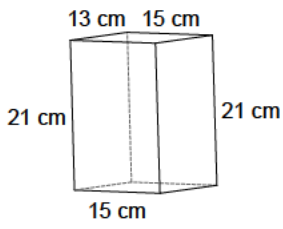

4095 cm^3

183)

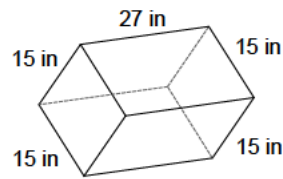

6075 in^3

184)

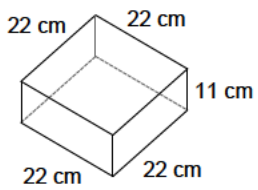

5324 cm^3

185)

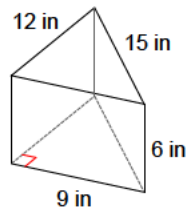

324 in^3

186)

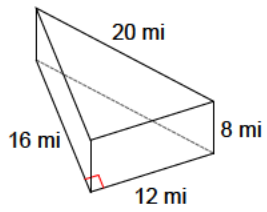

768 mi^3

187)

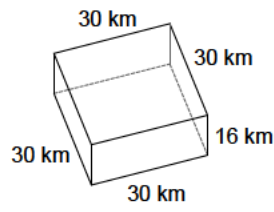

14400 km^3

188)

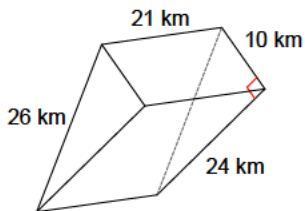

2520 km^3

189)

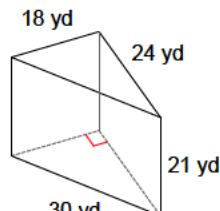

4540.5 yd^3

190)

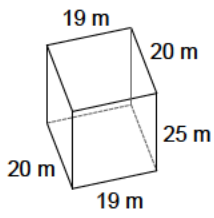

9500 m^3

191)

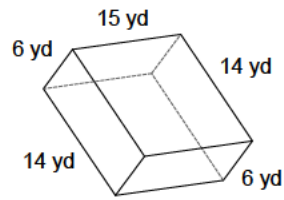

1260 yd^3

192)

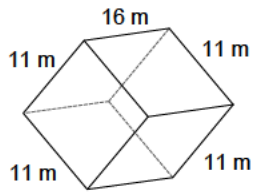

1936 m^3

193)

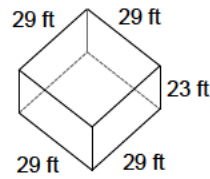

19343 ft^3

194)

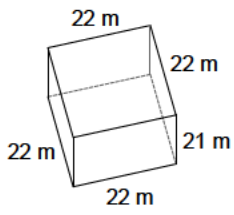

10164 m^3

195)

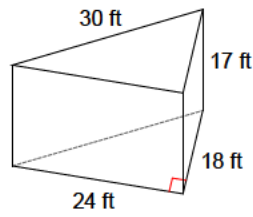

3672 ft^3

196)

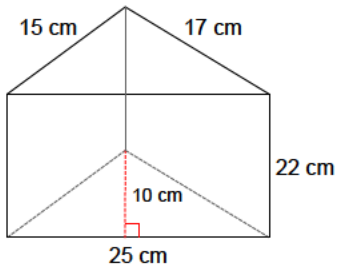

2750 cm^3

197)

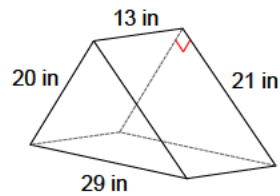

2730 in^3

198)

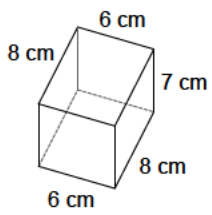

336 cm^3

199)

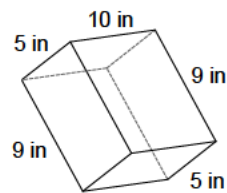

450 in^3

200)

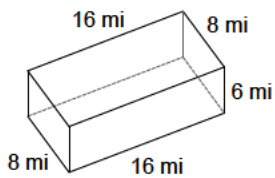

768 mi^3

Find the volume of each prism or pyramid:

201)

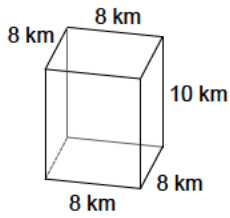

640 km^3

202)

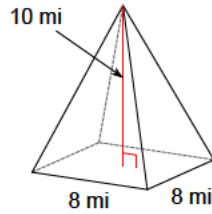

213.3 mi^3

203)

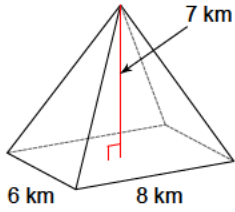

112 km^3

204)

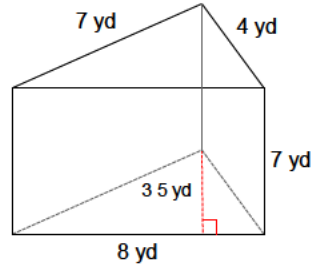

98 yd^3

205)

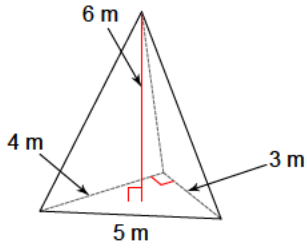

12 m^3

206)

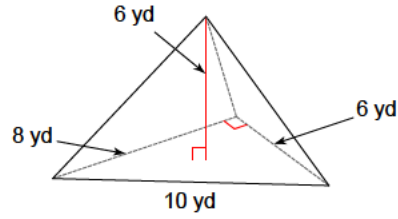

48 yd^3

207)

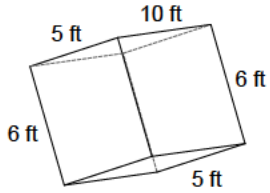

300 ft^3

208)

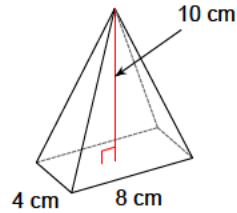

106.7 cm^3

209)

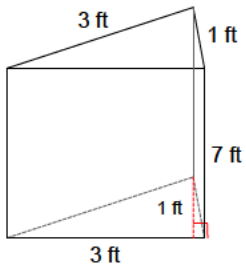

10.5 ft^3

210)

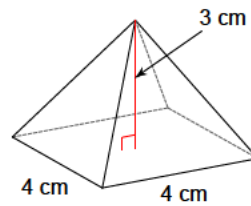

16 cm^3

211)

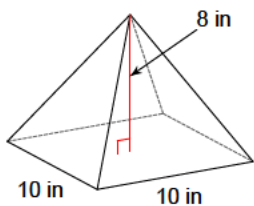

266.7 in^3

212)

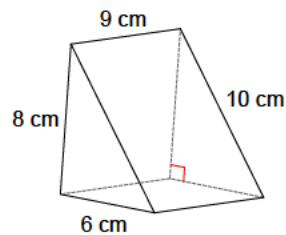

216 cm^3

213)

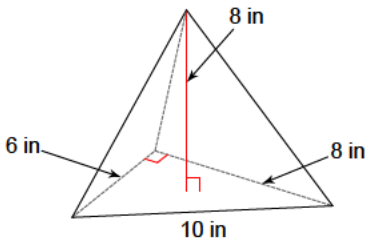

64 in^3

214)

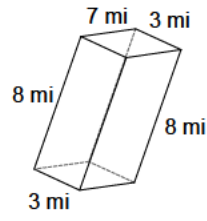

168 mi^3

215)

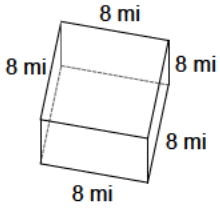

512 mi^3

216)

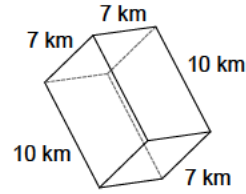

490 km^3

217)

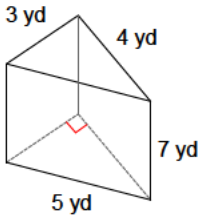

42 yd^3

218)

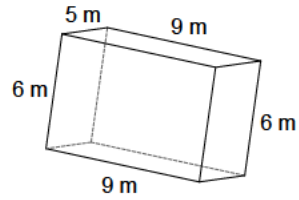

270 m^3

219)

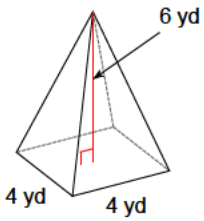

32 yd^3

220)

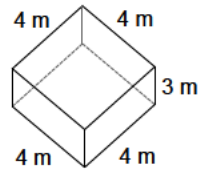

48 m^3

221)

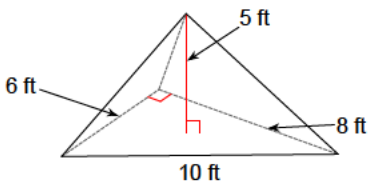

40 ft^3

222)

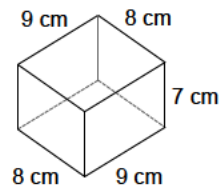

504 cm^3

223)

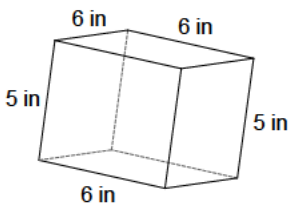

180 in^3

224)

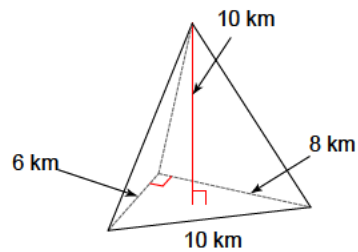

80 km^3

225)

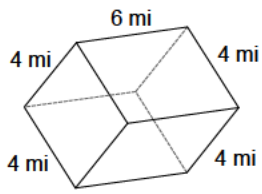

96 mi^3

226)

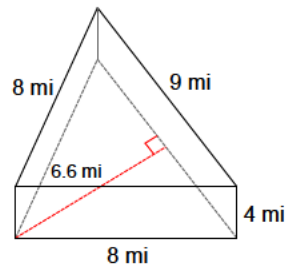

118.8 mi^3

227)

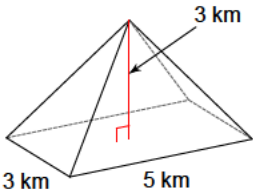

15 km^3

228)

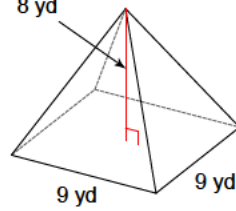

216 yd^3

229)

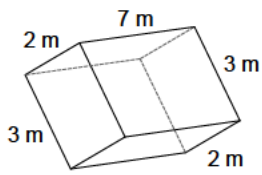

42 m^3

230)

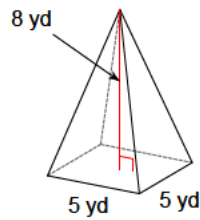

66.7 yd^3

231)

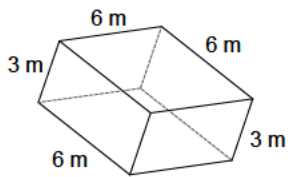

108 m^3

232)

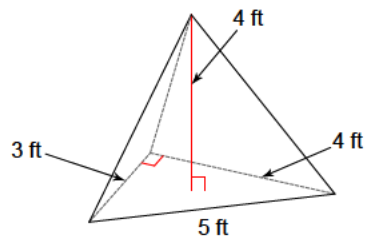

8 ft^3

233)

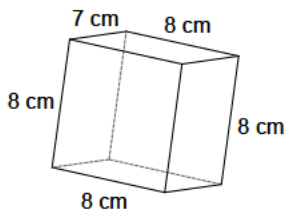

448 cm^3

234)

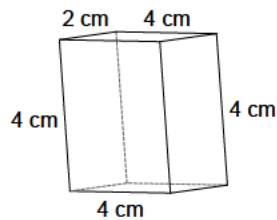

32 cm^3

235)

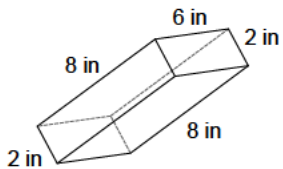

96 in^3

236)

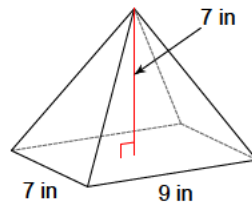

147 in^3

237)

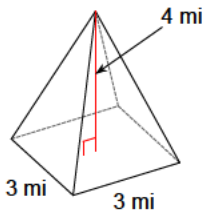

12 mi^3

238)

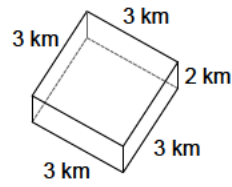

18 km^3

239)

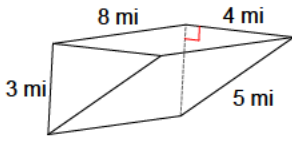

48.4 mi^3

240)

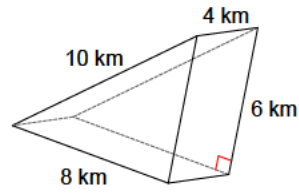

96 km^3

241)

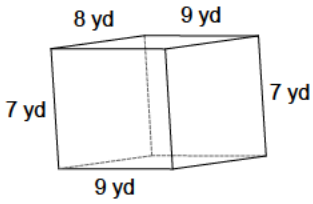

504 yd^3

242)

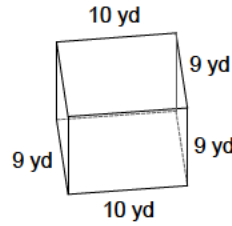

810 yd^3

243)

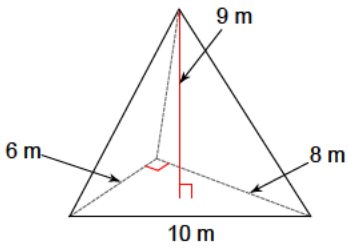

72 m^3

244)

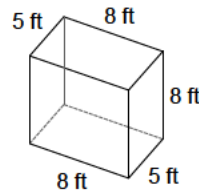

320 ft^3

245)

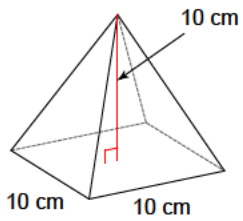

333.3 cm^3

246)

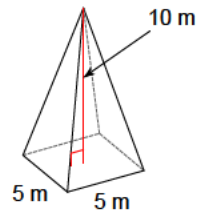

83.3 m^3

247)

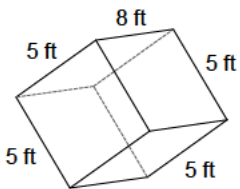

200 ft^3

248)

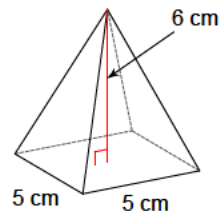

50 cm^3

249)

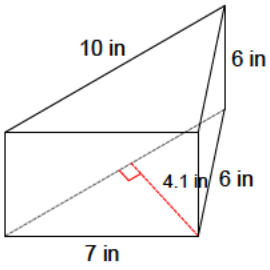

123 in^3

250)

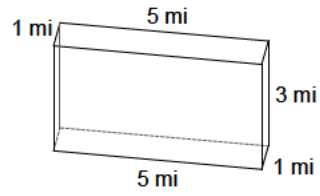

15 mi^3

251)

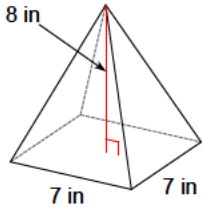

130.7 in^3

252)

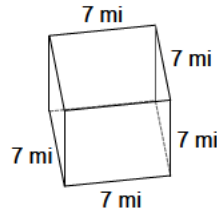

343 mi^3

253)

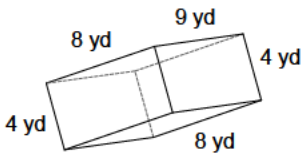

288 yd^3

254)

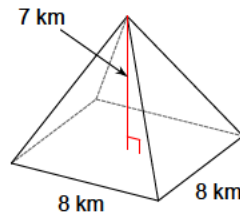

149.3 km^3

255)

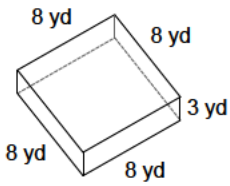

192 yd^3

256)

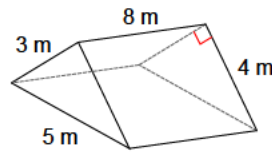

48 m^3

257)

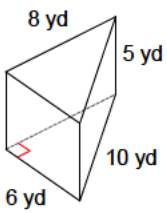

120 yd^3

258)

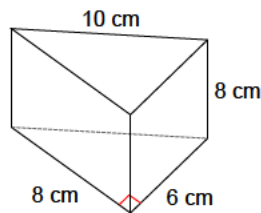

192 cm^3

259)

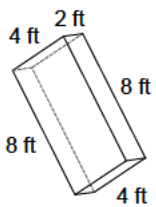

64 ft^3

260)

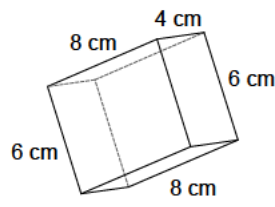

192 cm^3

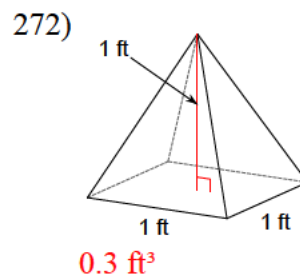
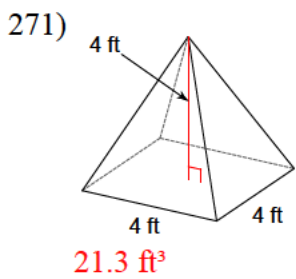
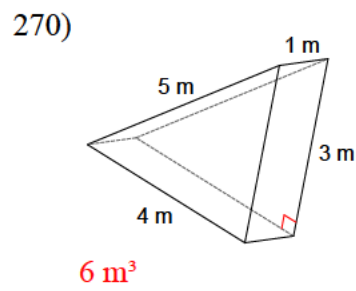
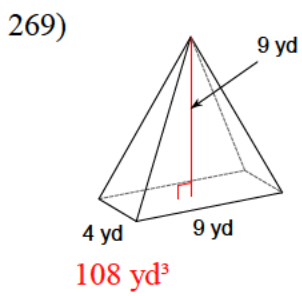
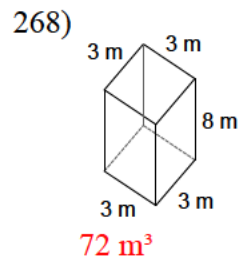
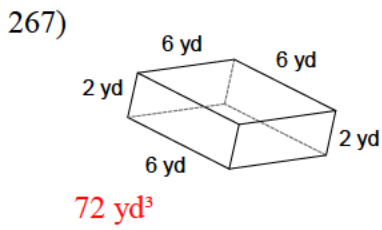
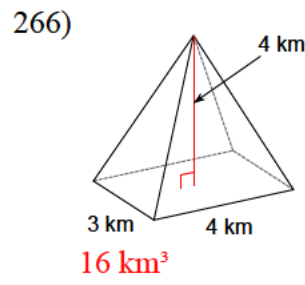
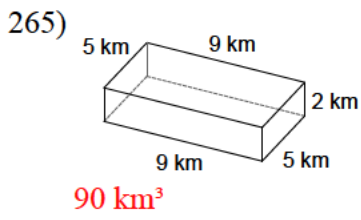
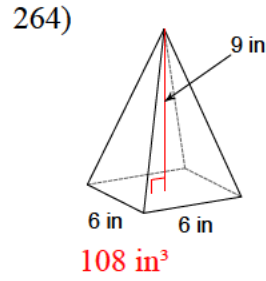
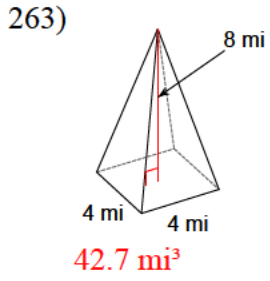
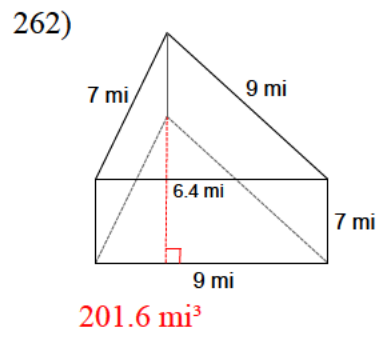
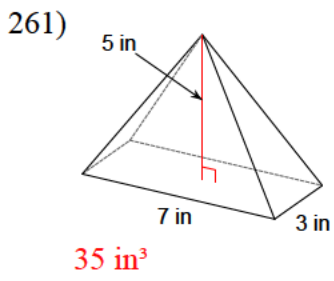

273)

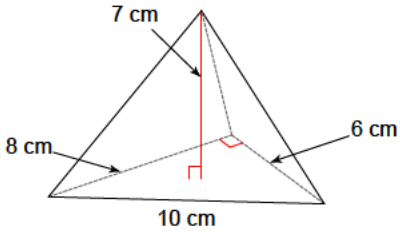

56 cm^3

274)

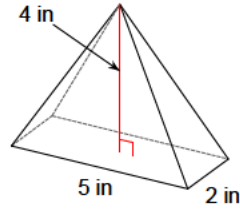

13.3 in^3

275)

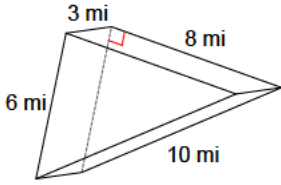

72 mi^3

276)

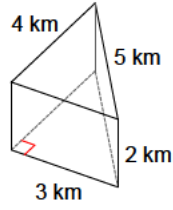

11.8 km^3

277)

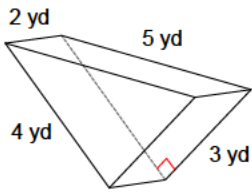

12 yd^3

278)

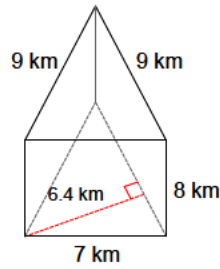

230.4 km^3

279)

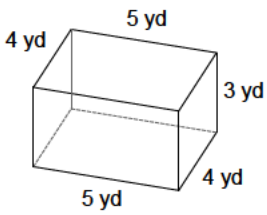

60 yd^3

280)

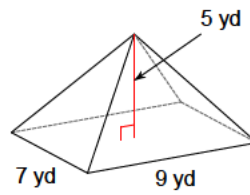

105 yd^3

281)

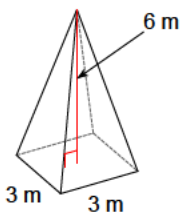

18 m^3

282)

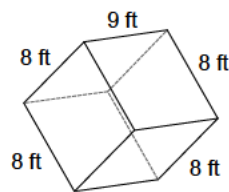

576 ft^3

283)

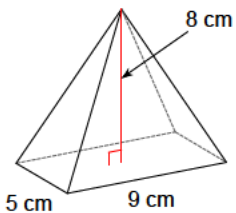

120 cm^3

284)

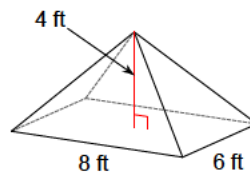

64 ft^3

285)

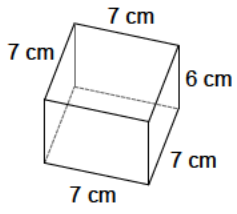

294 cm^3

286)

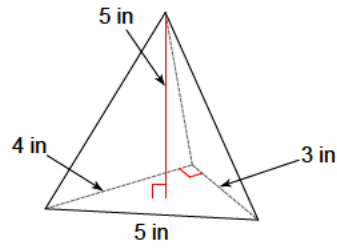

10 in^3

287)

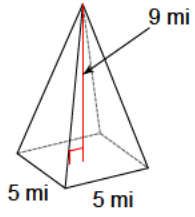

75 mi^3

288)

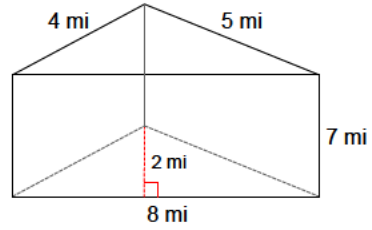

56 mi^3

289)

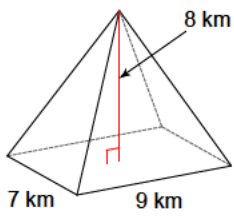

168 km^3

290)

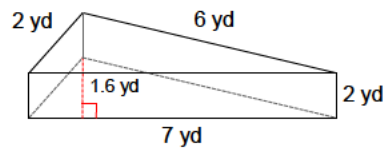

11.2 yd^3

291)

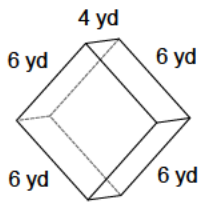

144 yd^3

292)

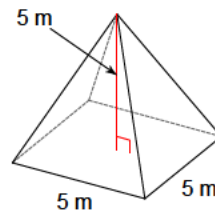

41.7 m^3

293)

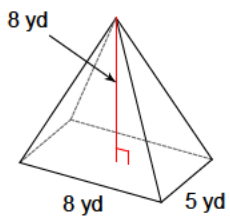

106.7 yd^3

294)

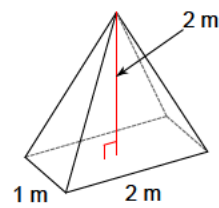

1.3 m^3

295)

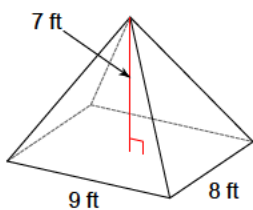

168 ft^3

296)

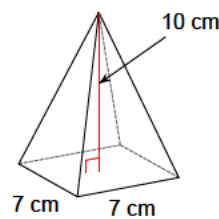

163.3 cm^3

297)

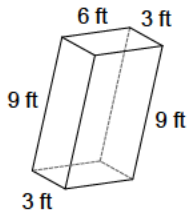

162 ft³

298)

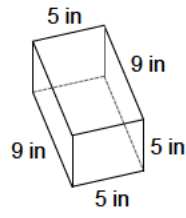

225 in³

299)

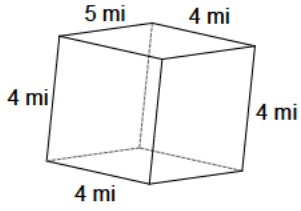

80 mi³

300)

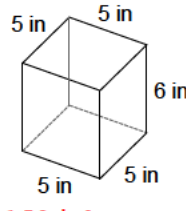

150 in³

301)

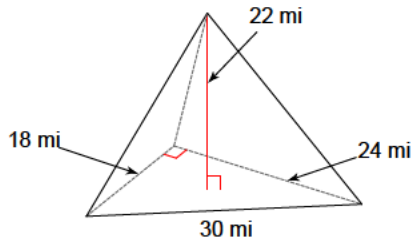

1584 mi³

302)

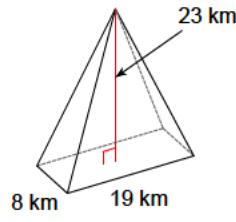

1165.3 km³

303)

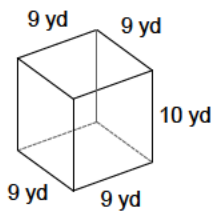

810 yd³

304)

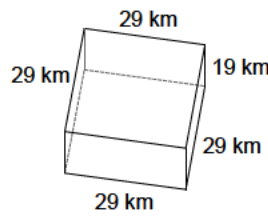

15979 km³

305)

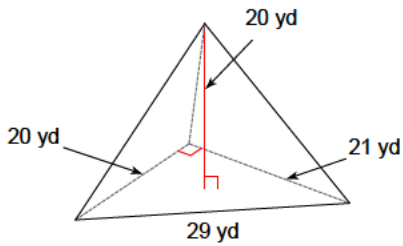

1400 yd³

306)

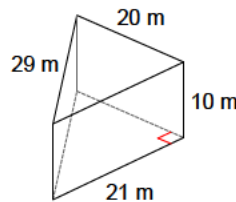

2114.3 m³

307)

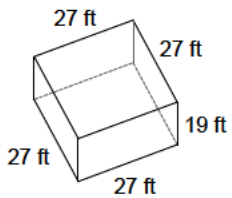

13851 ft³

308)

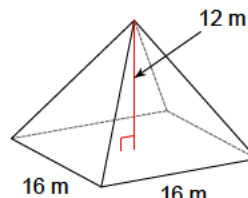

1024 m³

309)

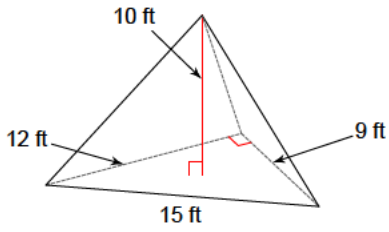

180 ft^3

310)

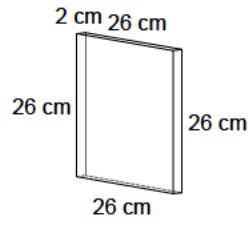

1352 cm^3

311)

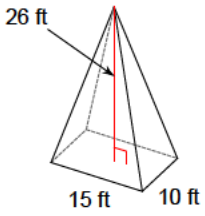

1300 ft^3

312)

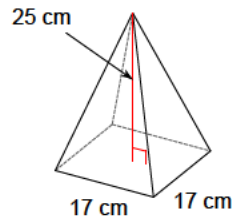

2408.3 cm^3

313)

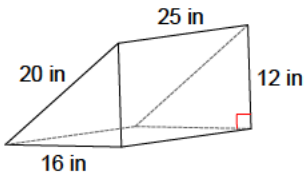

2400 in^3

314)

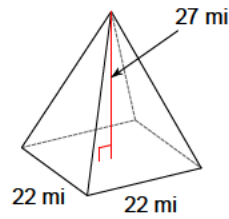

4356 mi^3

315)

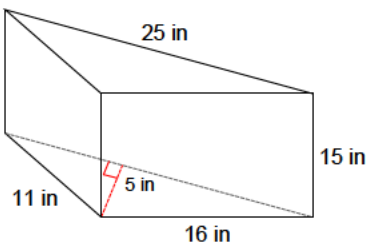

937.5 in^3

316)

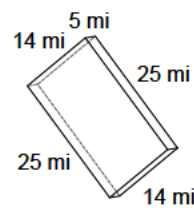

1750 mi^3

317)

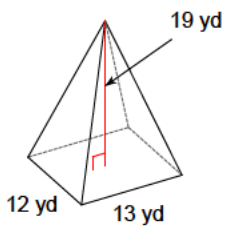

988 yd^3

318)

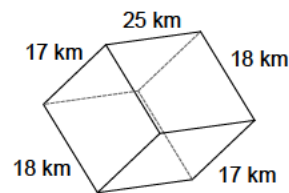

7650 km^3

319)

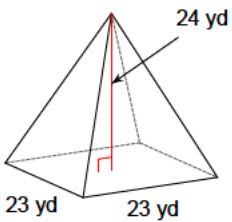

4232 yd^3

320)

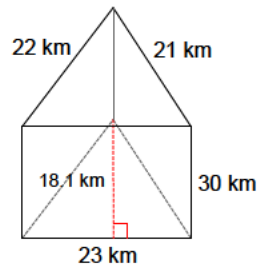

6244.5 km^3

321)

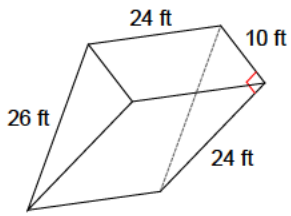
 2880 ft^3

322)

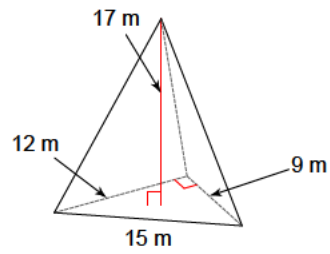
 306 m^3

323)

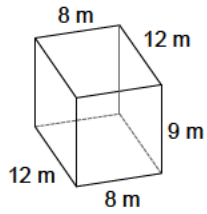
 864 m^3

324)

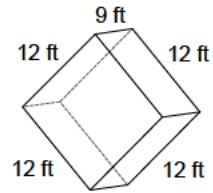
 1296 ft^3

325)

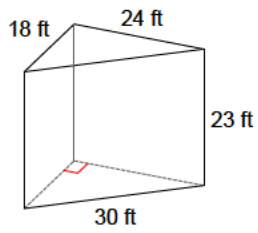
 4968 ft^3

326)

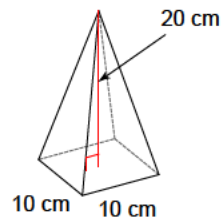
 666.7 cm^3

327)

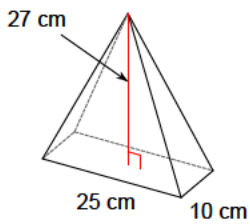
 2250 cm^3

328)

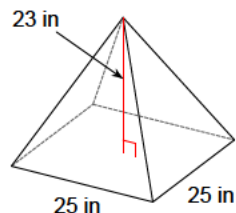
 4791.7 in^3

329)

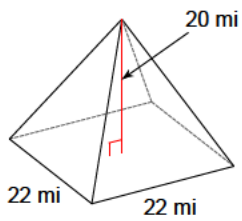
 3226.7 mi^3

330)

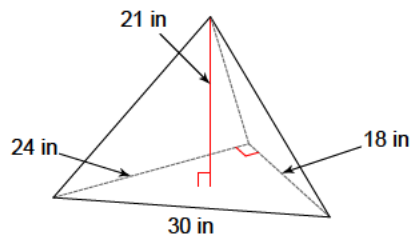
 1512 in^3

331)

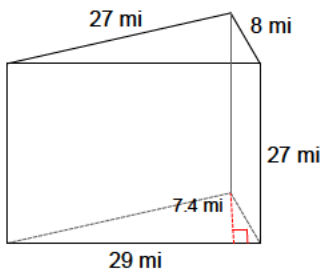
 2897.1 mi^3

332)

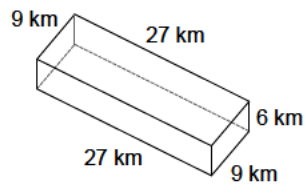
 1458 km^3

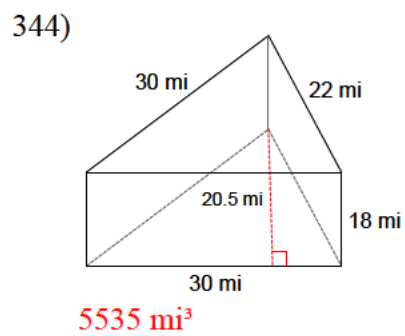
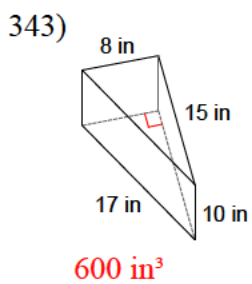
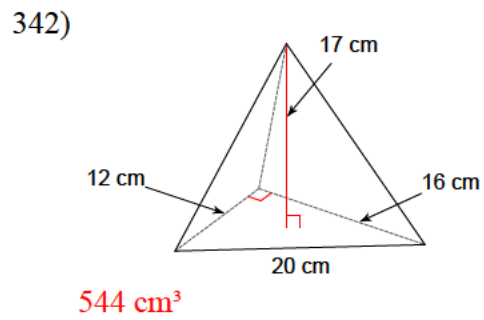
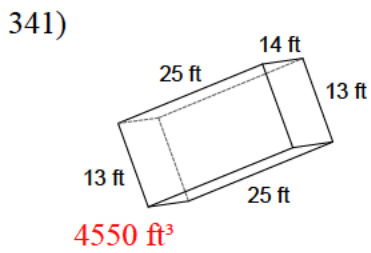
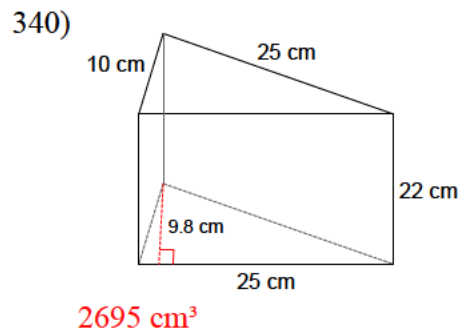
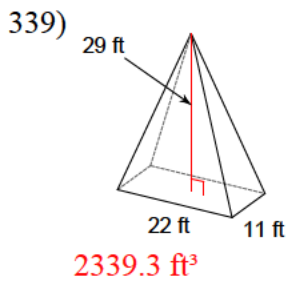
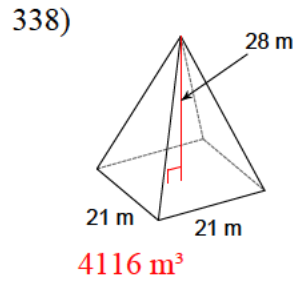
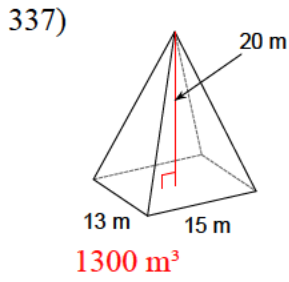
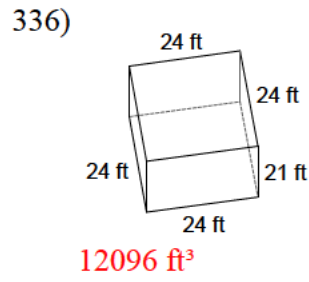
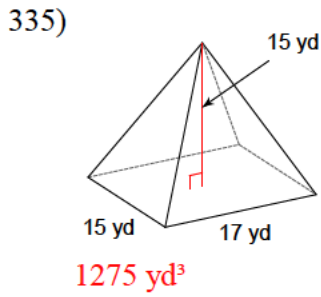
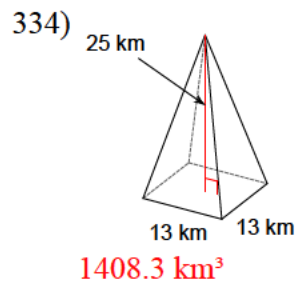
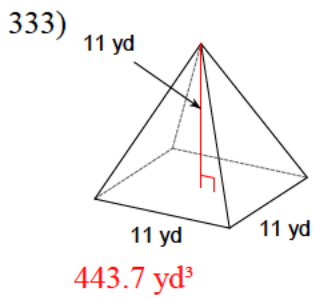

345)

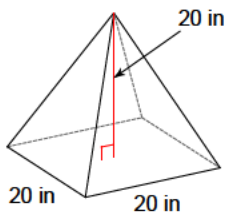

2666.7 in^3

346)

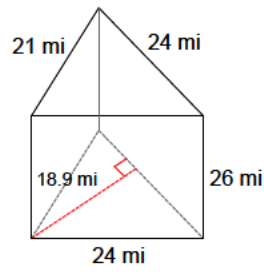

5896.8 mi^3

347)

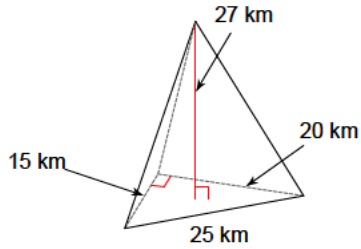

1350 km^3

348)

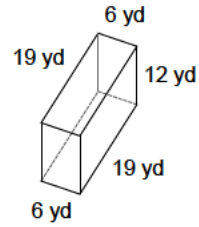

1368 yd^3

349)

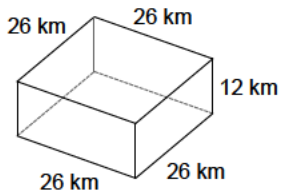

8112 km^3

350)

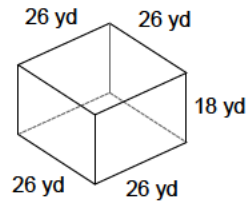

12168 yd^3

351)

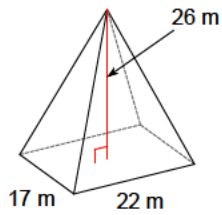

3241.3 m^3

352)

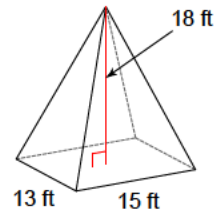

1170 ft^3

353)

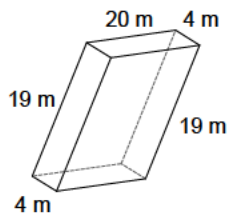

1520 m^3

354)

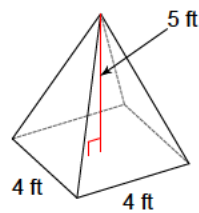

26.7 ft^3

355)

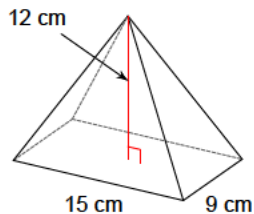

540 cm^3

356)

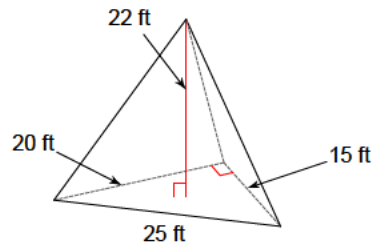

1100 ft^3

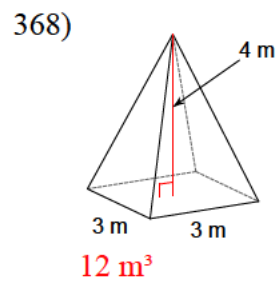
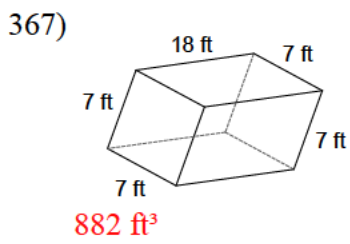
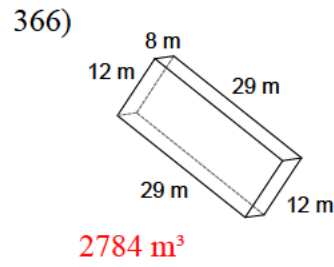
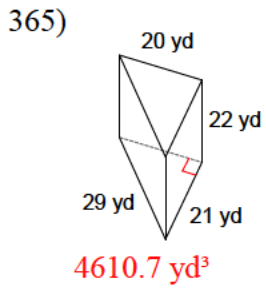
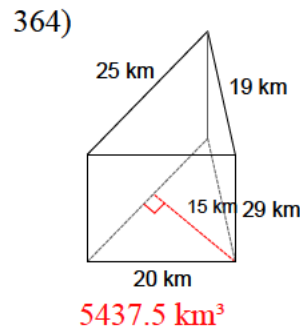
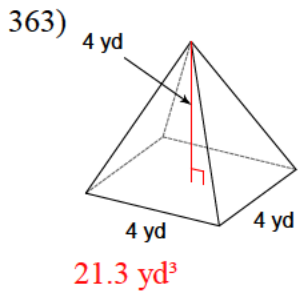
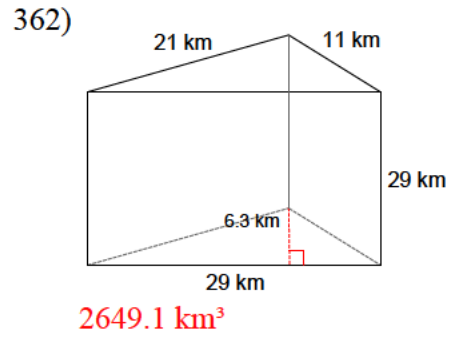
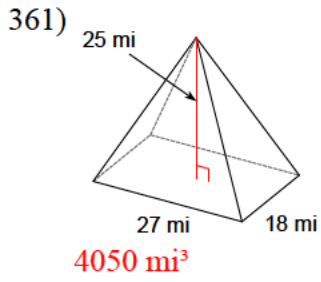
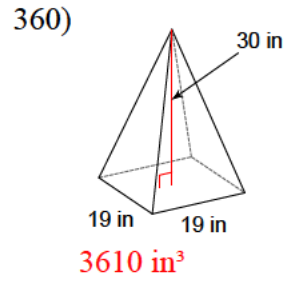
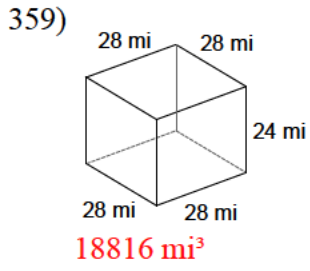
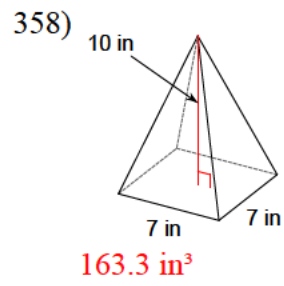
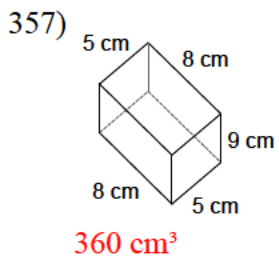

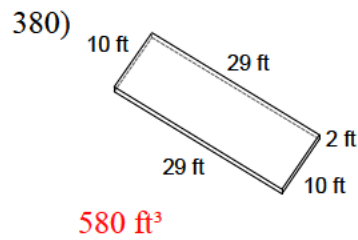
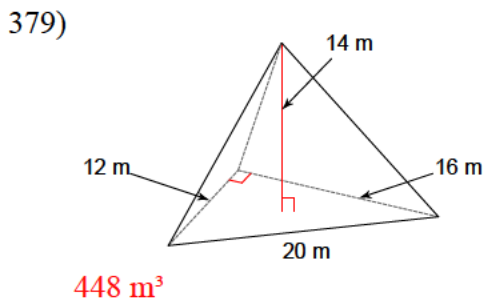
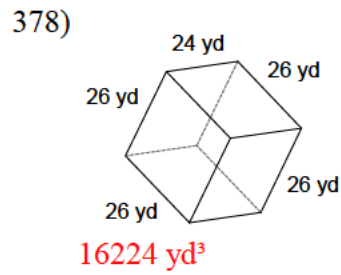
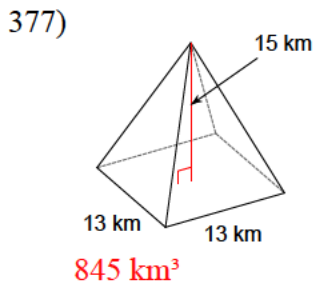
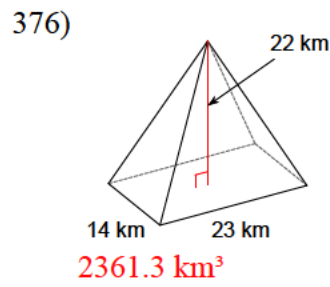
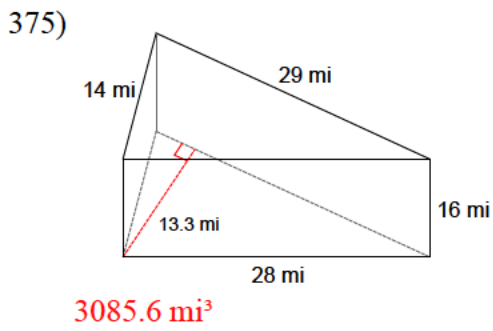
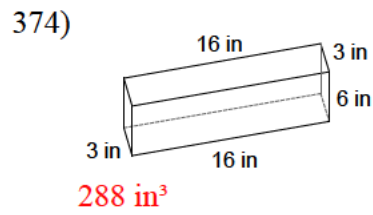
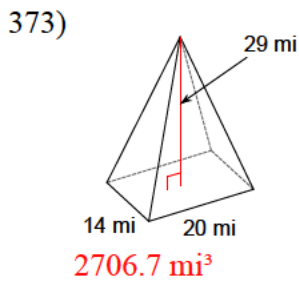
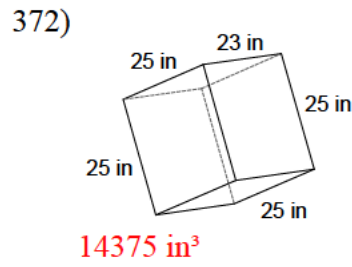
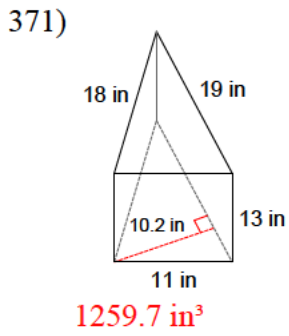
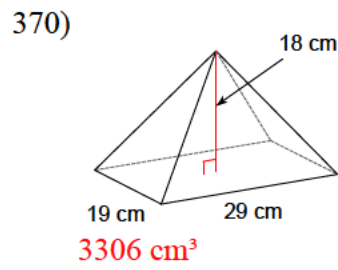
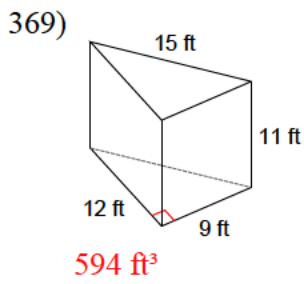

381)

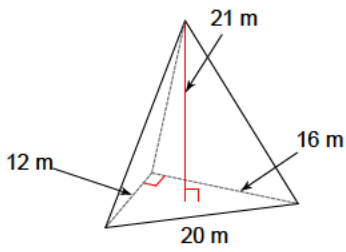

672 m^3

382)

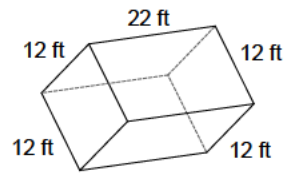

3168 ft^3

383)

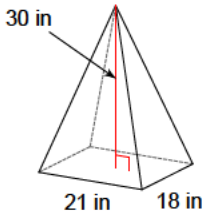

3780 in^3

384)

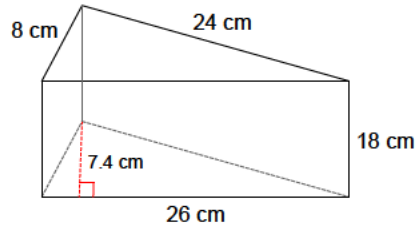

1731.6 cm^3

385)

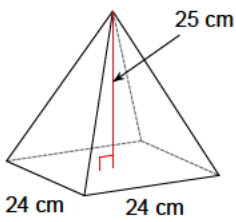

4800 cm^3

386)

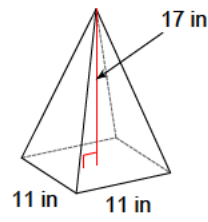

685.7 in^3

387)

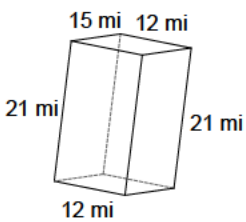

3780 mi^3

388)

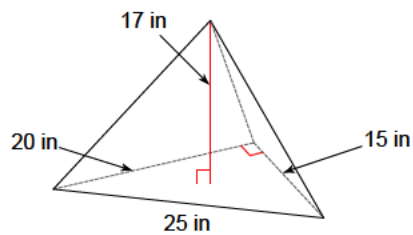

850 in^3

389)

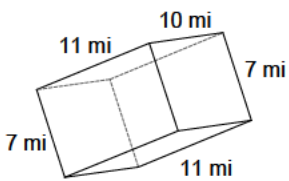

770 mi^3

390)

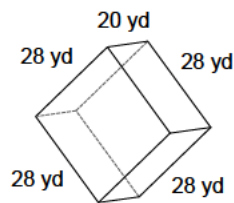

15680 yd^3

391)

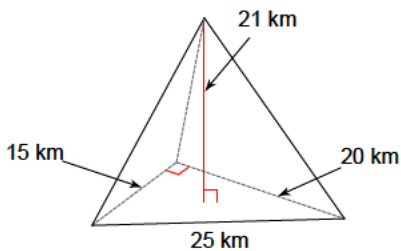

1050 km^3

392)

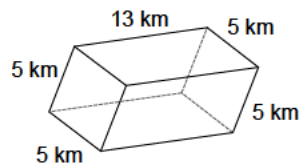

325 km^3

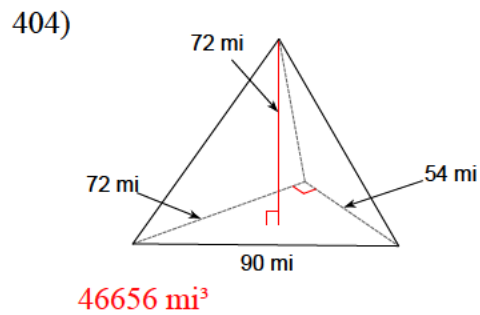
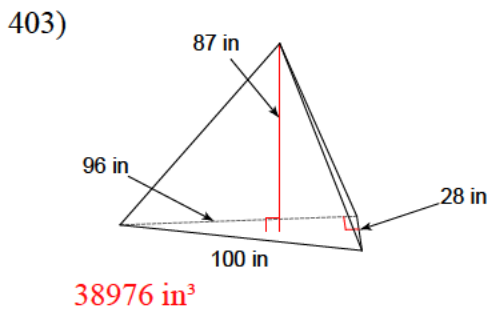
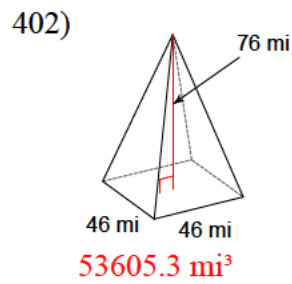
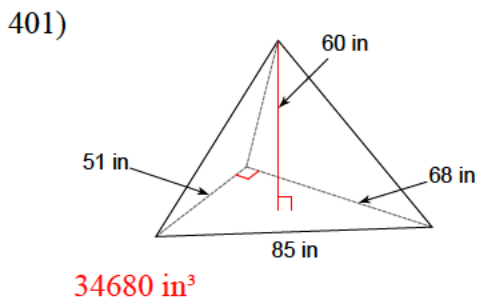
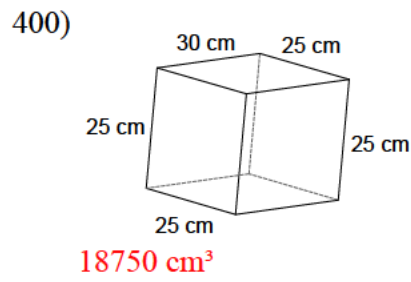
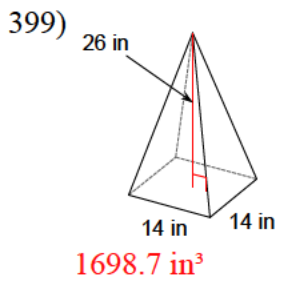
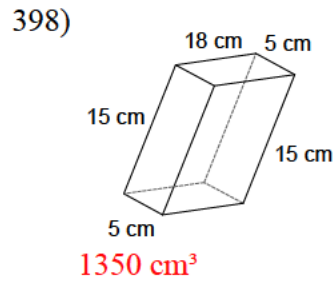
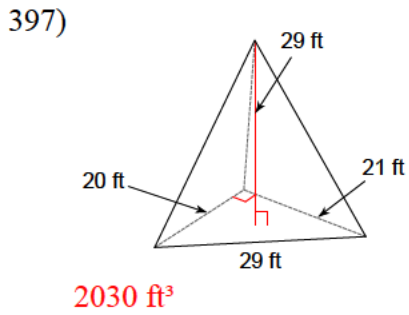
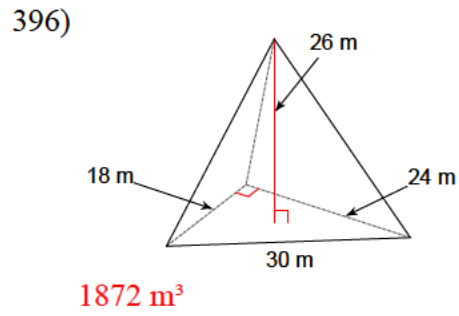
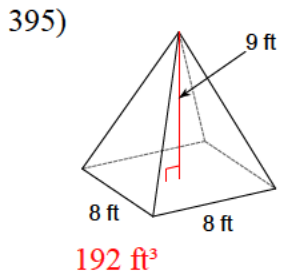
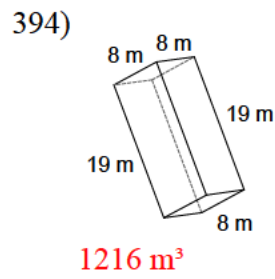
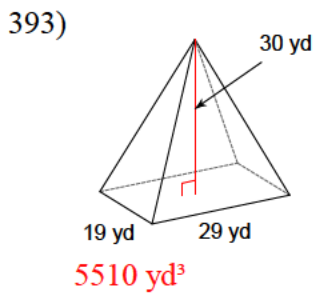

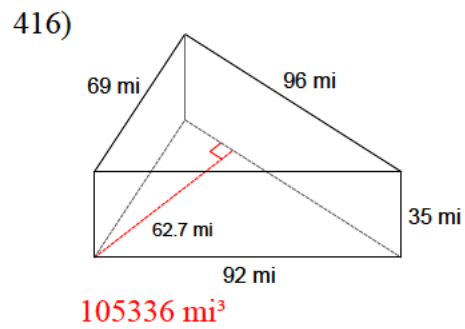
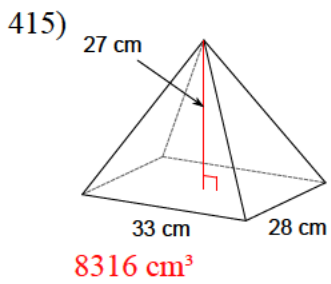
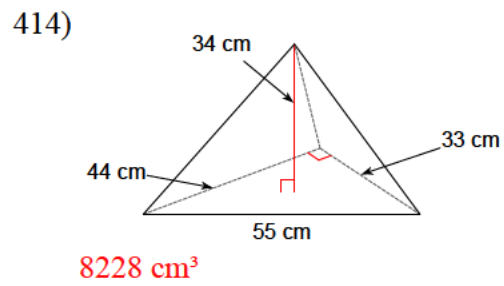
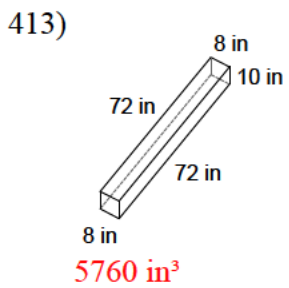
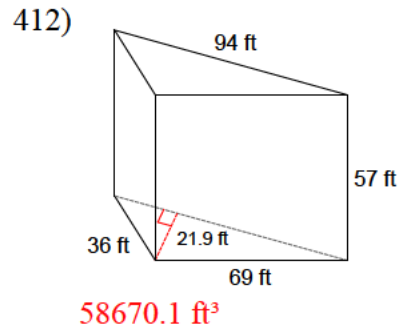
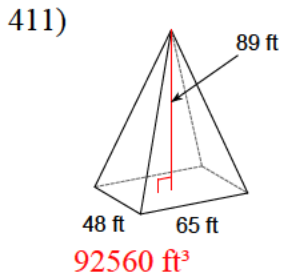
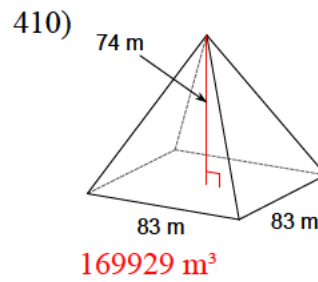
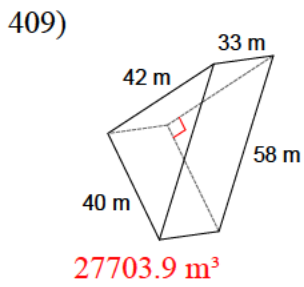
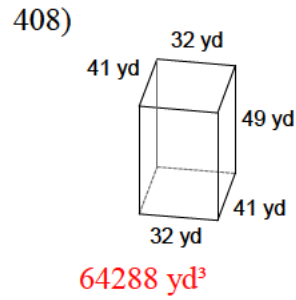
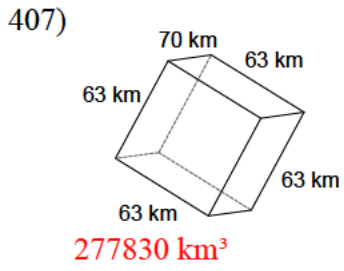
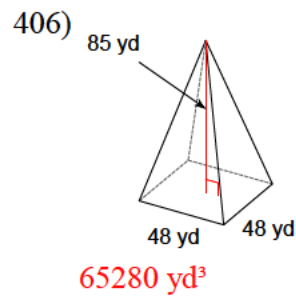
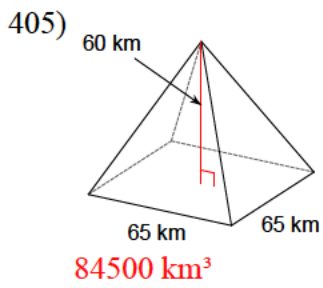

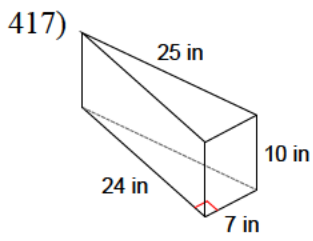

840 in^3

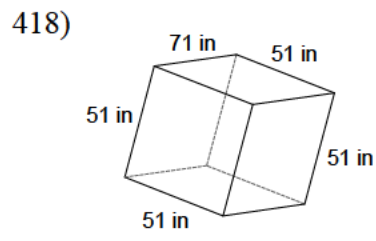

184671 in^3

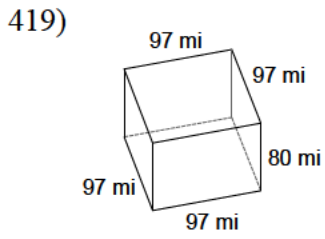

752720 mi^3

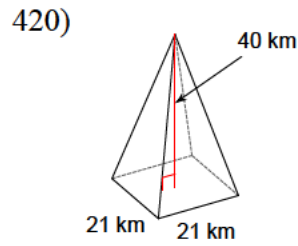

5880 km^3

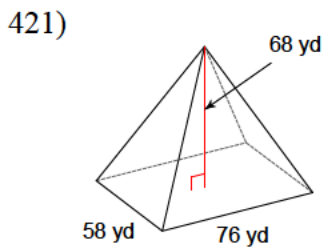

99914.7 yd^3

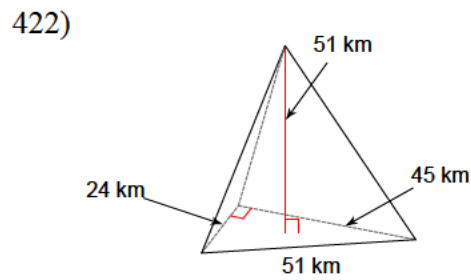

9180 km^3

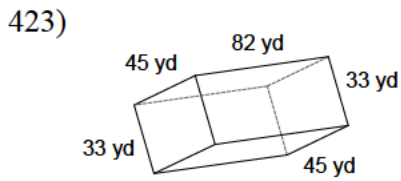

121770 yd^3

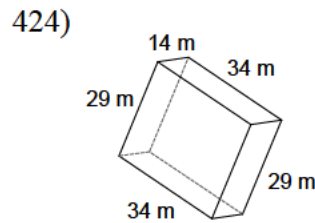

13804 m^3

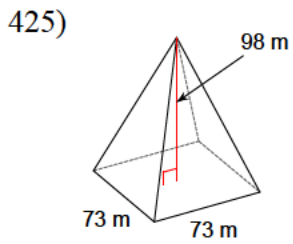

174081 m^3

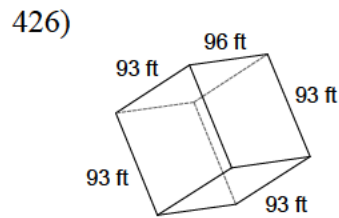

830304 ft^3

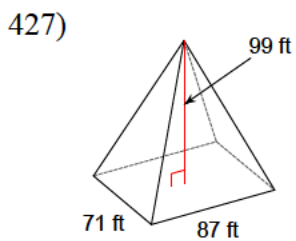

203841 ft^3

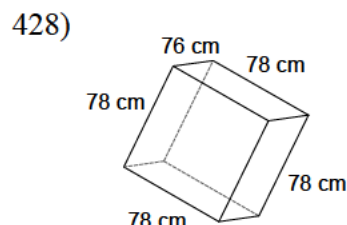

462384 cm^3

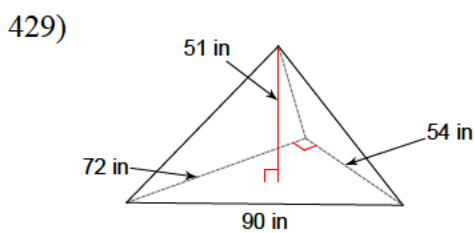

33048 in^3

430)

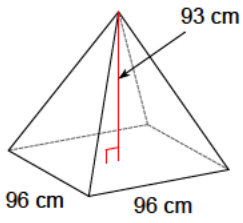

285696 cm^3

431)

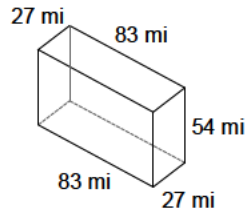

121014 mi^3

432)

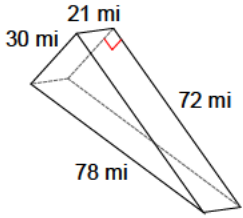

22680 mi^3

433)

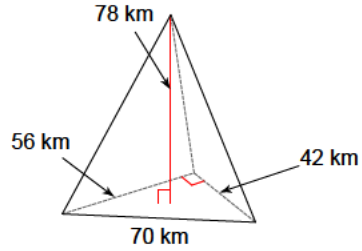

30576 km^3

434)

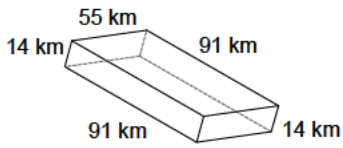

70070 km^3

435)

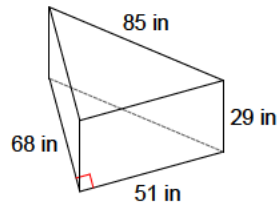

50262.1 in^3

436)

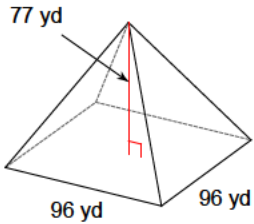

236544 yd^3

437)

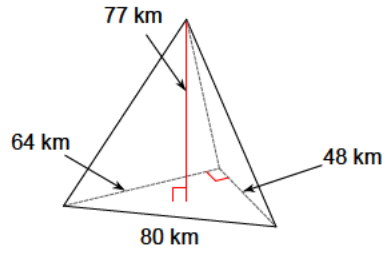

39424 km^3

438)

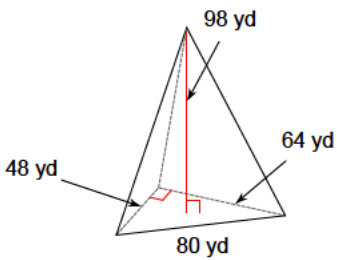

50176 yd^3

439)

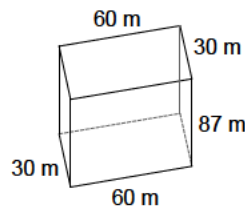

156600 m^3

440)

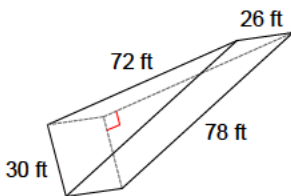

28080 ft^3

441)

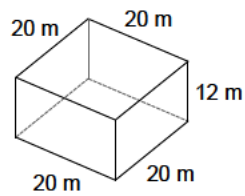

4800 m^3

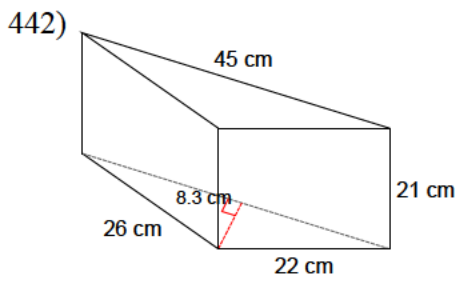

3921.8 cm^3

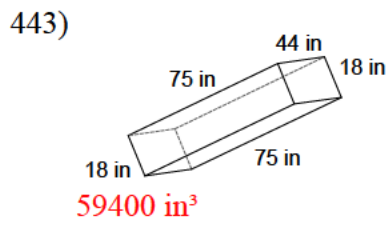

59400 in^3

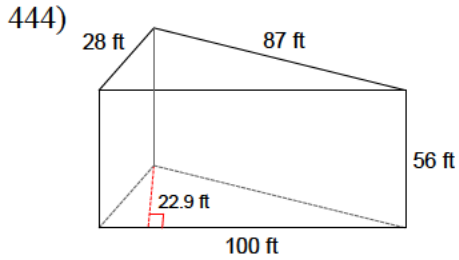

64120 ft^3

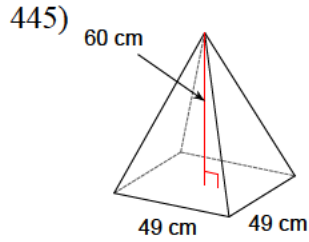

48020 cm^3

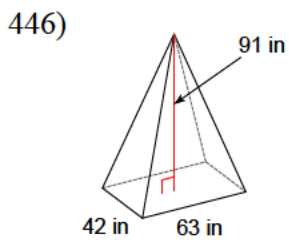

80262 in^3

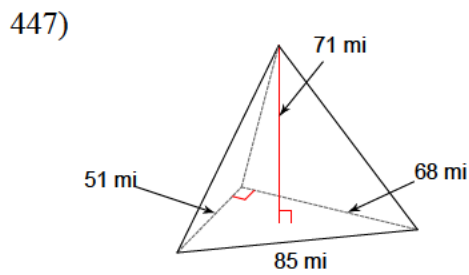

41038 mi^3

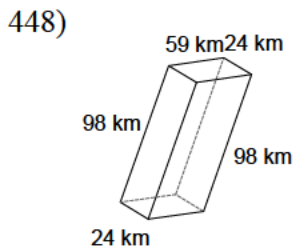

138768 km^3

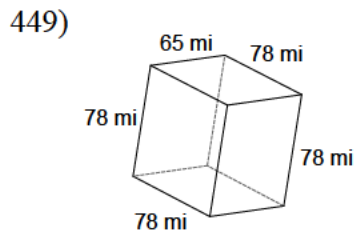

395460 mi^3

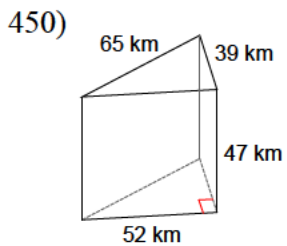

47658 km^3

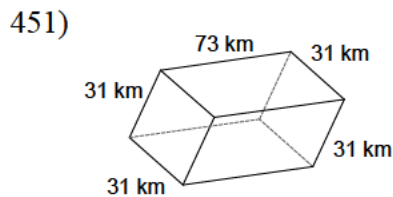

70153 km^3

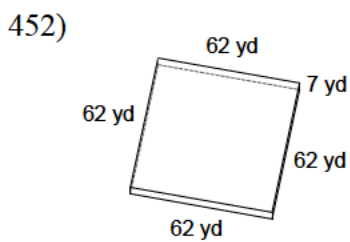

26908 yd^3

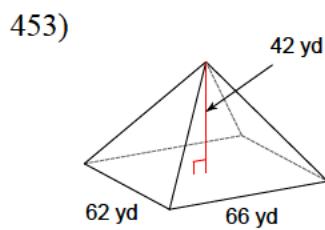

57288 yd^3

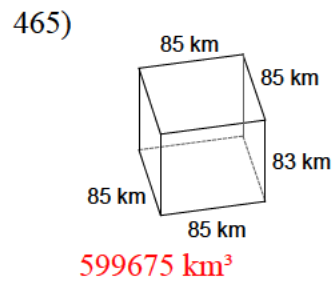
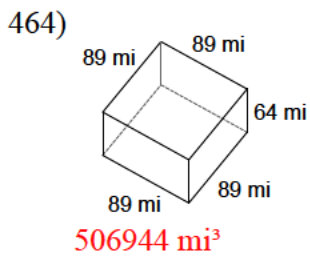
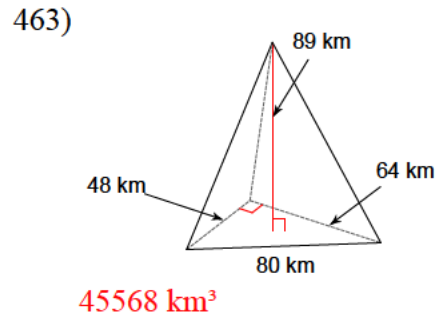
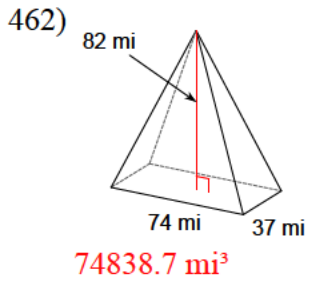
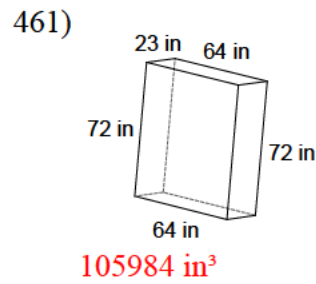
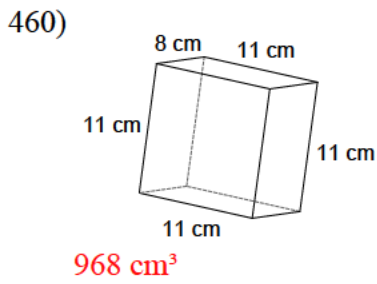
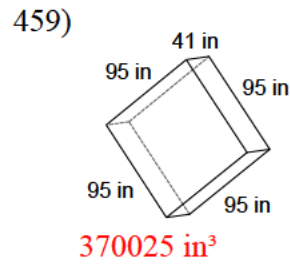
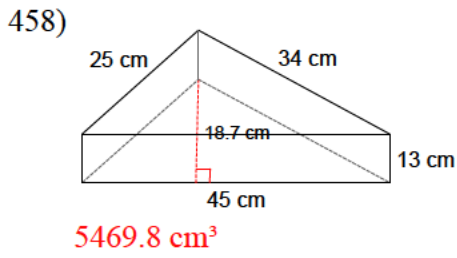
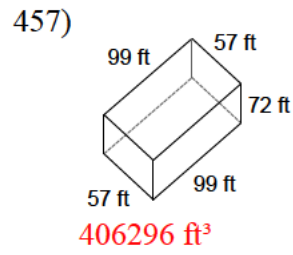
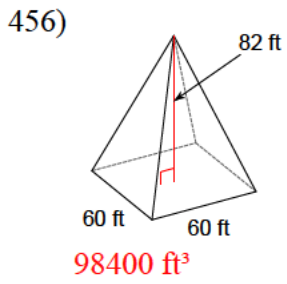
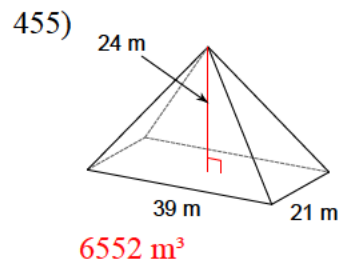
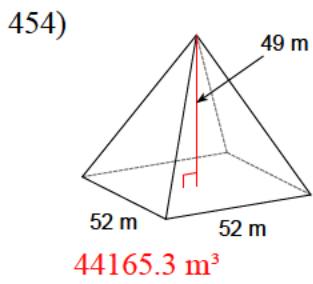

466)

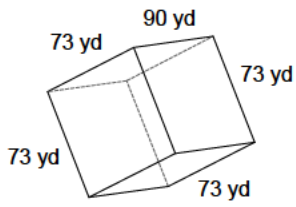

479610 yd^3

467)

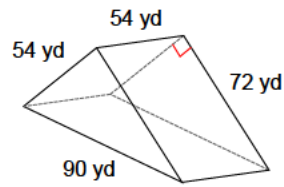

104976 yd^3

468)

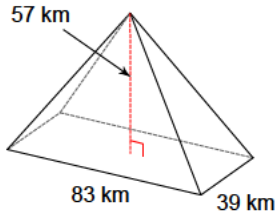

61503 km^3

469)

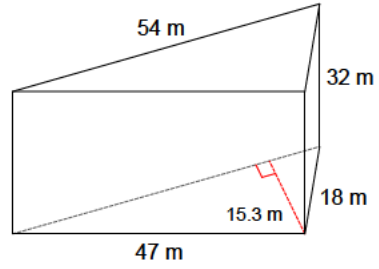

13219.2 m^3

470)

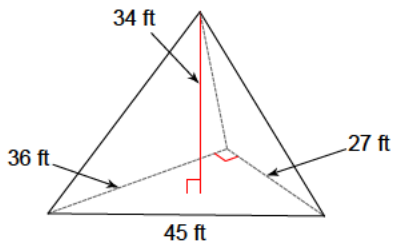

5508 ft^3

471)

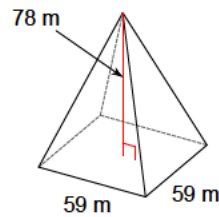

90506 m^3

472)

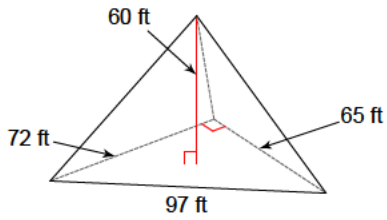

46800 ft^3

473)

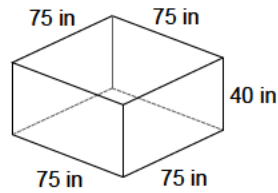

225000 in^3

474)

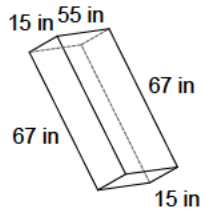

55275 in^3

475)

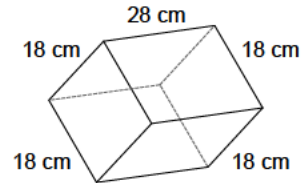

9072 cm^3

476)

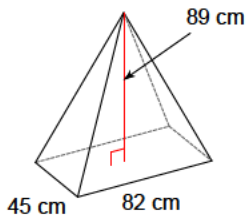

109470 cm^3

477)

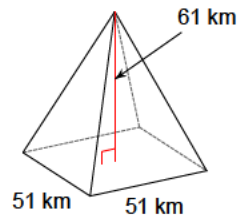

52887 km^3

478)

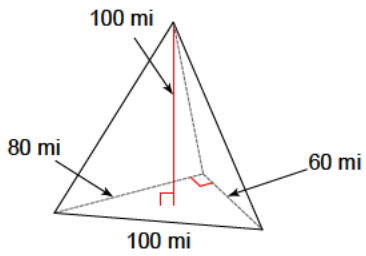

80000 mi^3

479)

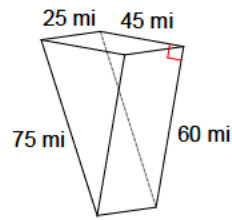

33771.2 mi^3

480)

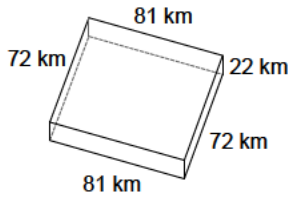

128304 km^3

481)

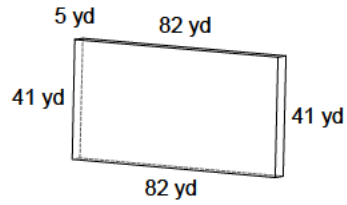

16810 yd^3

482)

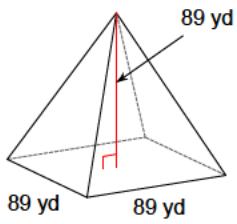

234990 yd^3

483)

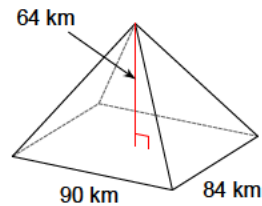

161280 km^3

484)

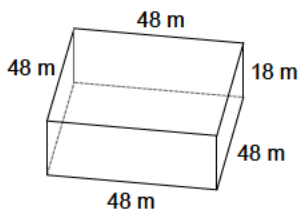

41472 m^3

485)

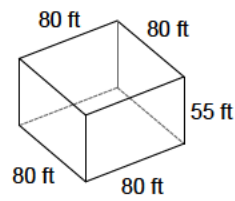

352000 ft^3

486)

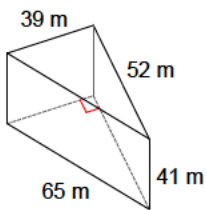

41574 m^3

487)

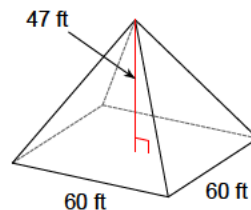

56400 ft^3

488)

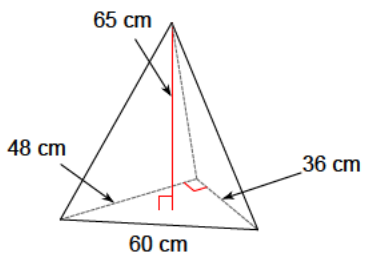

18720 cm^3

489)

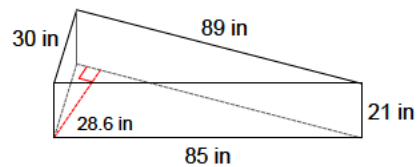

26726.7 in^3

490)

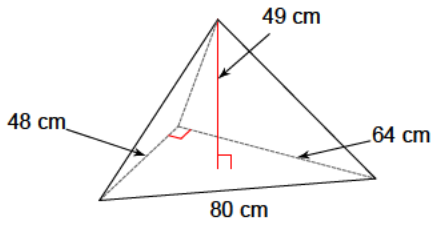

25088 cm^3

491)

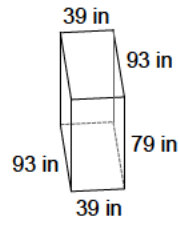

286533 in^3

492)

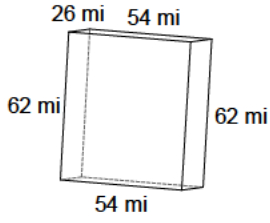

87048 mi^3

493)

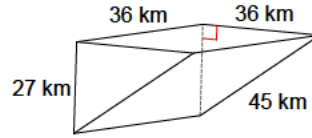

17496 km^3

494)

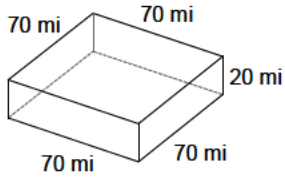

98000 mi^3

495)

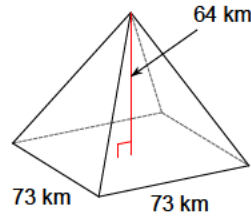

113685 km^3

496)

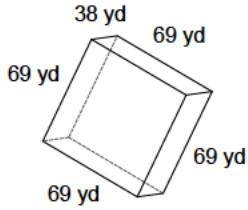

180918 yd^3

497)

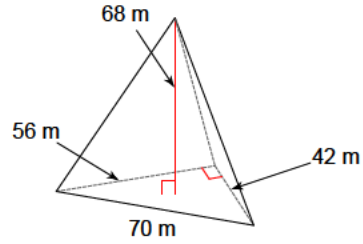

26656 m^3

498)

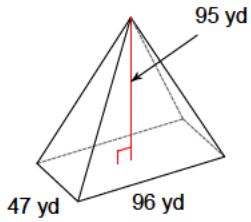

142880 yd^3

499)

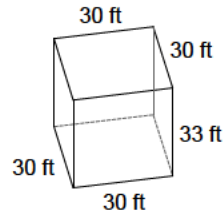

29700 ft^3

500)

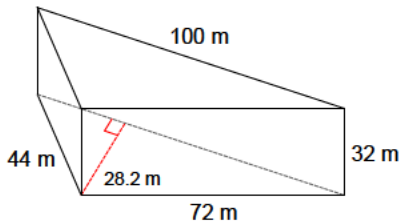

45120 m^3

Find the volume of each prism, pyramid or cylinder:

501)

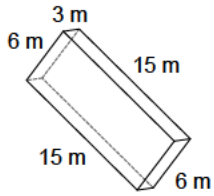

270 m^3

502)

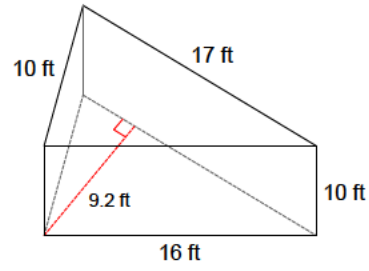

782 ft^3

503)

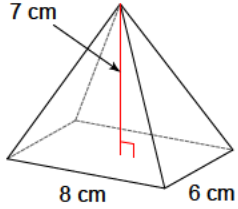

112 cm^3

504)

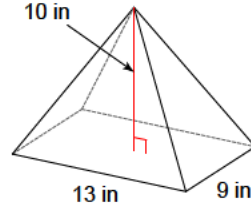

390 in^3

505)

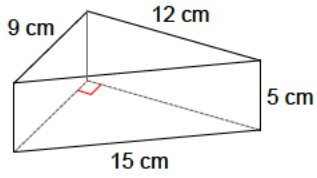

270 cm^3

506)

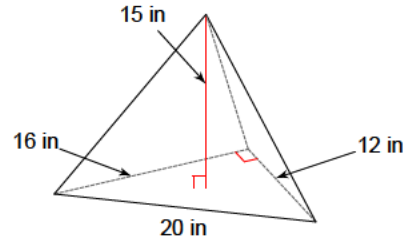

480 in^3

507)

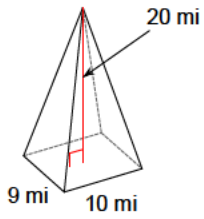

600 mi^3

508)

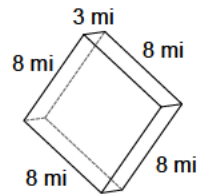

192 mi^3

509)

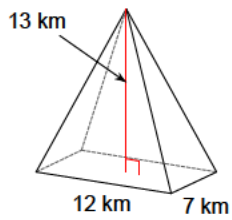

364 km^3

510)

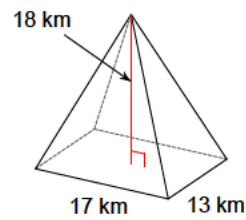

1326 km^3

511)

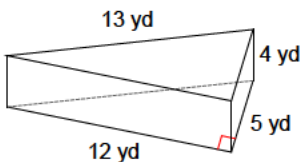

120 yd^3

512)

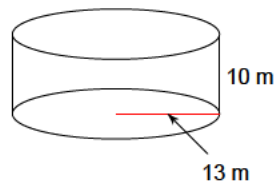

5309.3 m^3

513)

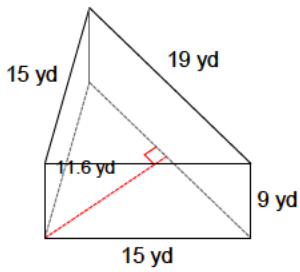

991.8 yd^3

514)

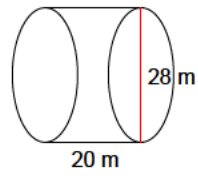

12315 m^3

515)

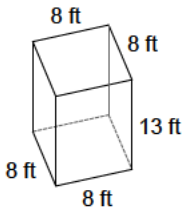

832 ft^3

516)

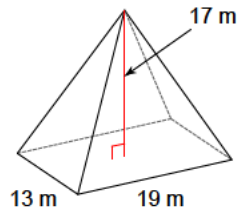

1399.7 m^3

517)

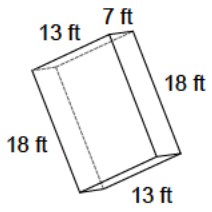

1638 ft^3

518)

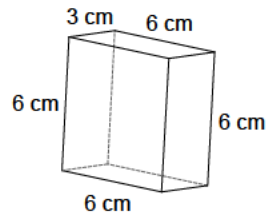

108 cm^3

519)

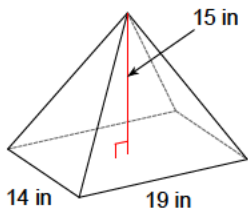

1330 in^3

520)

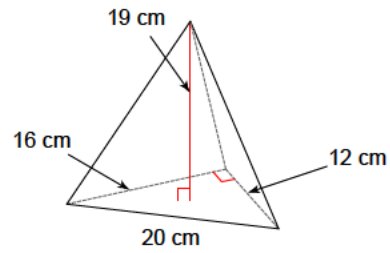

608 cm^3

521)

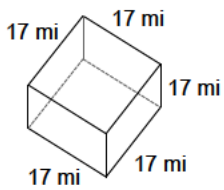

4913 mi^3

522)

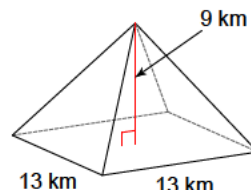

507 km^3

523)

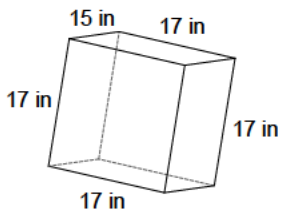

4335 in^3

524)

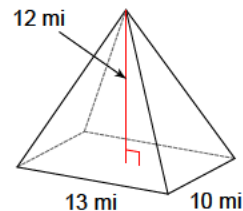

520 mi^3

525)

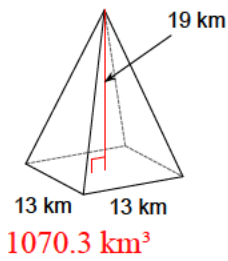

526)

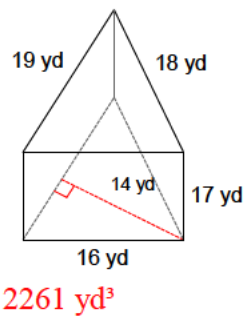

527)

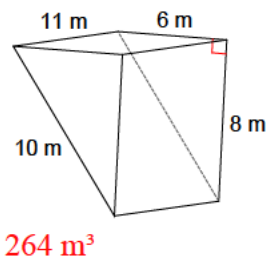

528)

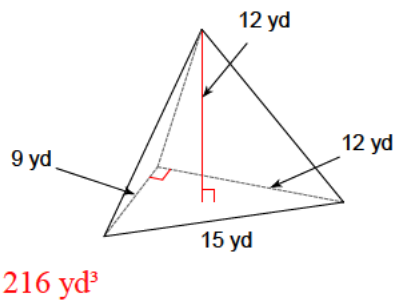

529)

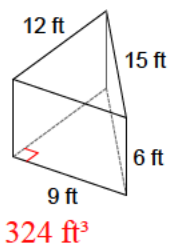

530)

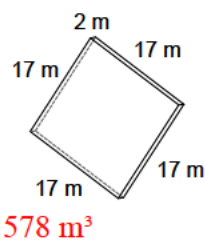

531)

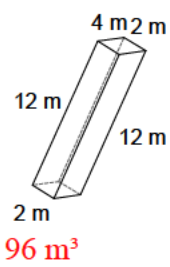

532)

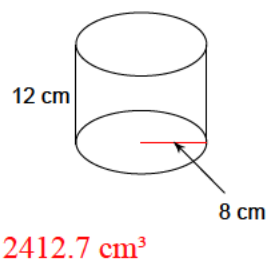

533)

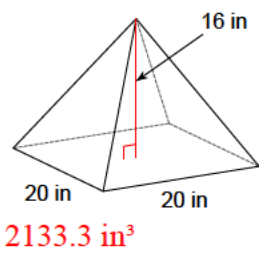

534)

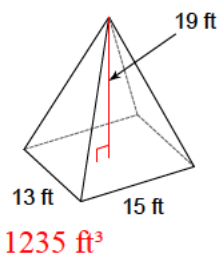

535)

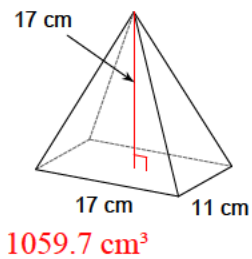

536)

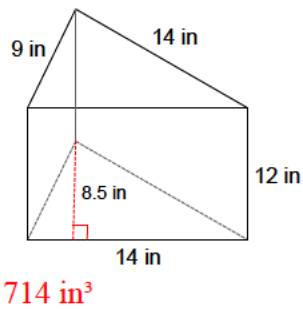

537)

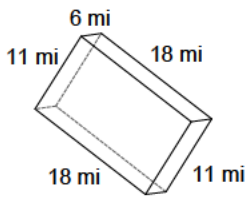

1188 mi^3

538)

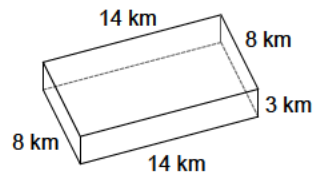

336 km^3

539)

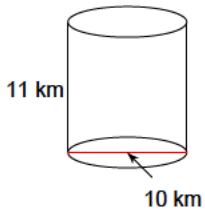

863.9 km^3

540)

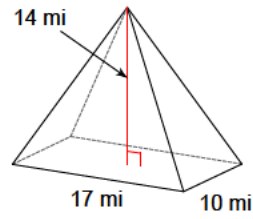

793.3 mi^3

541)

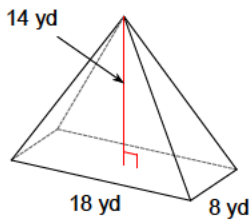

672 yd^3

542)

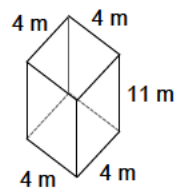

176 m^3

543)

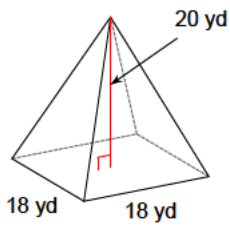

2160 yd^3

544)

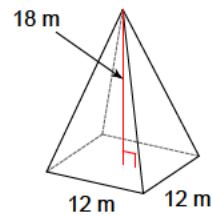

864 m^3

545)

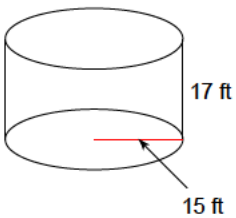

12016.6 ft^3

546)

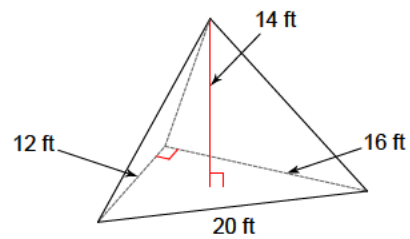

448 ft^3

547)

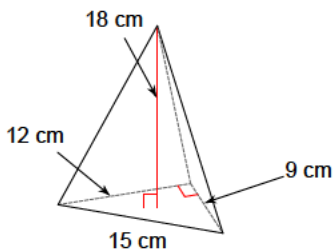

324 cm^3

548)

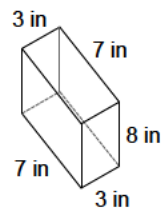

168 in^3

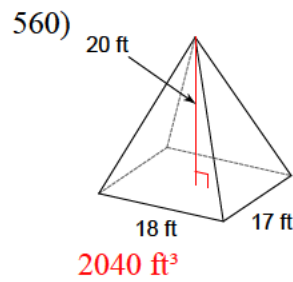
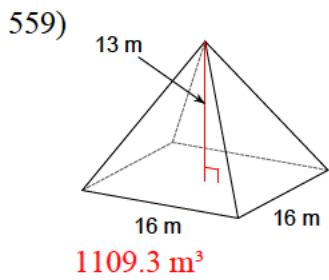
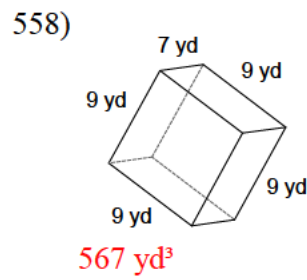
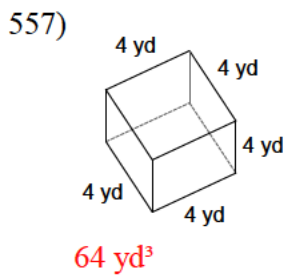
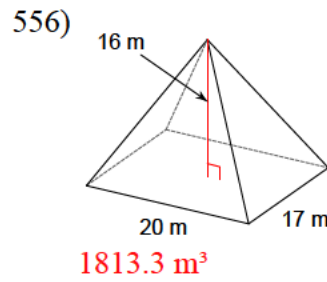
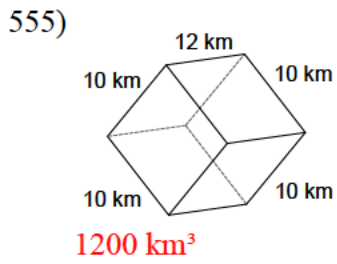
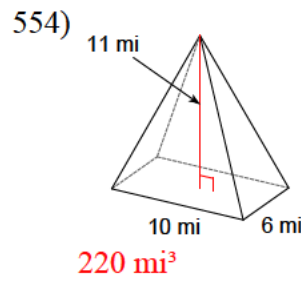
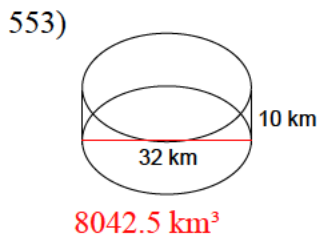
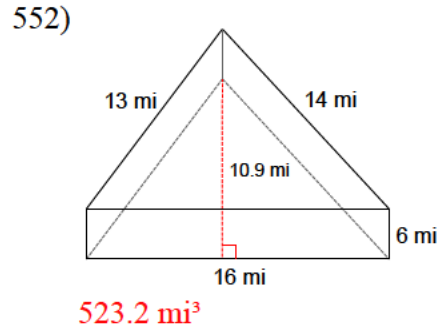
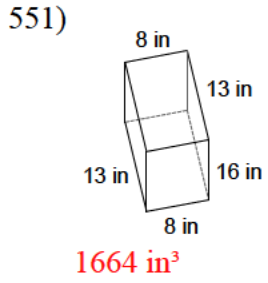
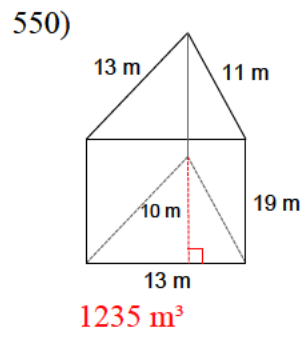
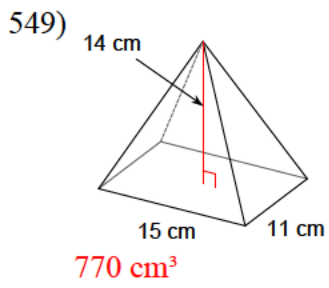

561)

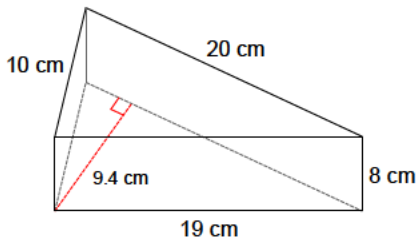

752 cm^3

562)

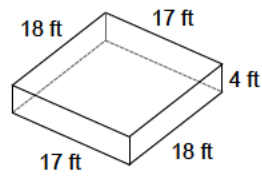

1224 ft^3

563)

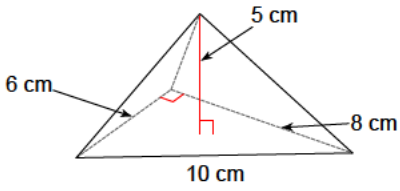

40 cm^3

564)

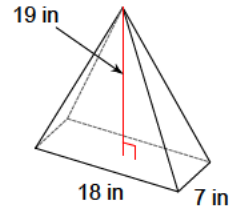

798 in^3

565)

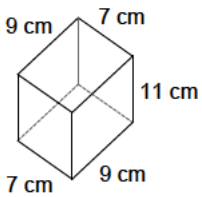

693 cm^3

566)

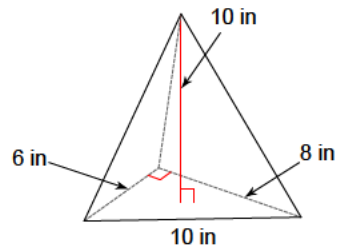

80 in^3

567)

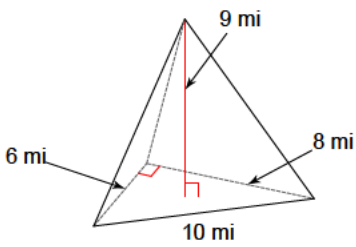

72 mi^3

568)

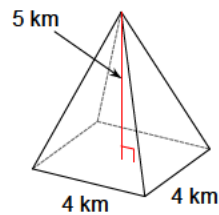

26.7 km^3

569)

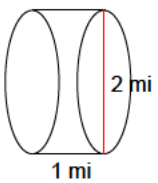

3.1 mi^3

570)

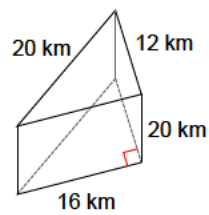

1920 km^3

571)

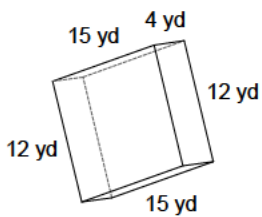

720 yd^3

572)

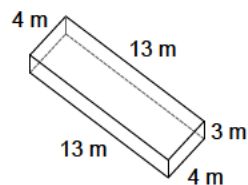

156 m^3

573)

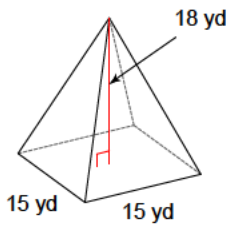

1350 yd³

574)

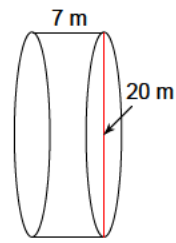

2199.1 m³

575)

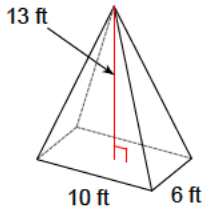

260 ft³

576)

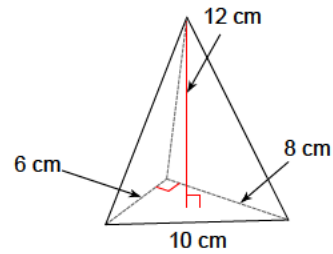

96 cm³

577)

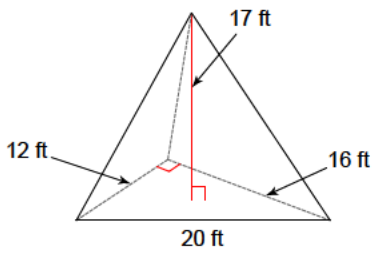

544 ft³

578)

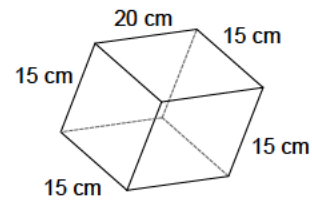

4500 cm³

579)

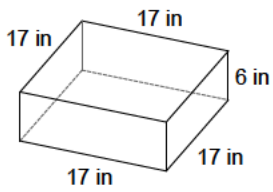

1734 in³

580)

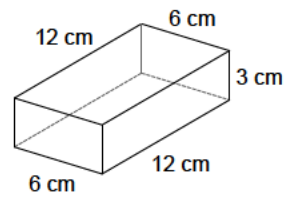

216 cm³

581)

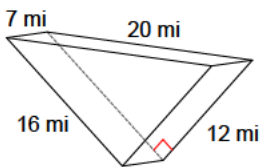

672 mi³

582)

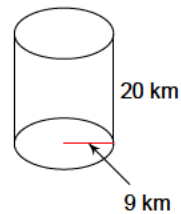

5089.4 km³

583)

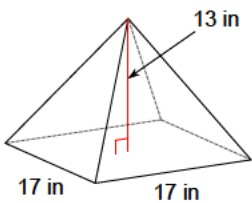

1252.3 in³

584)

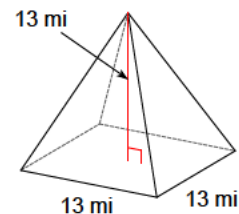

732.3 mi³

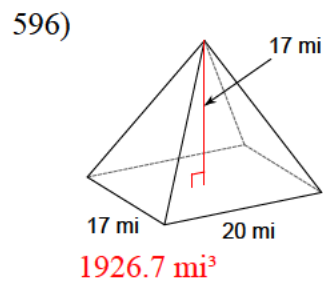
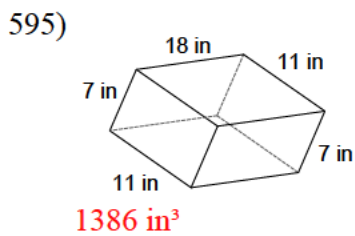
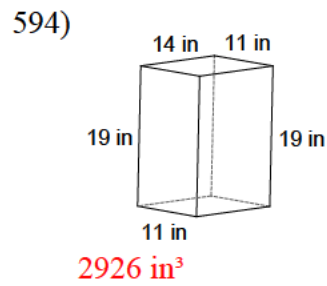
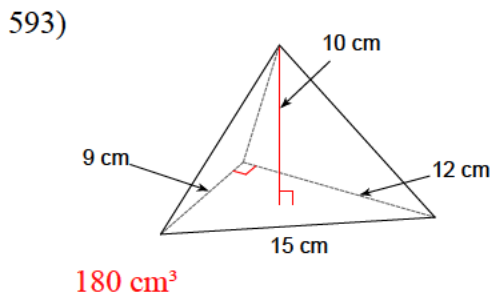
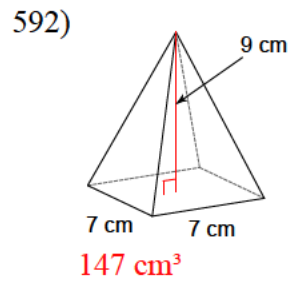
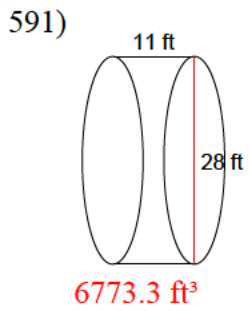
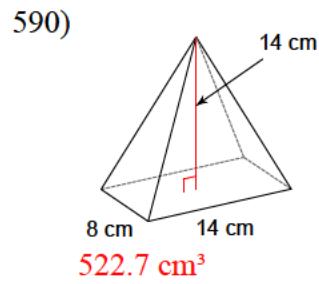
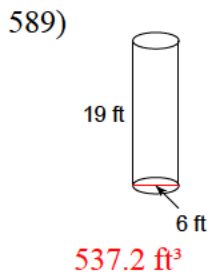
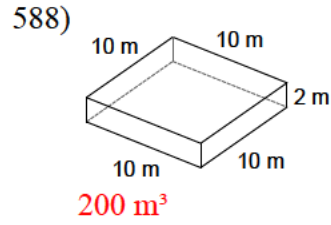
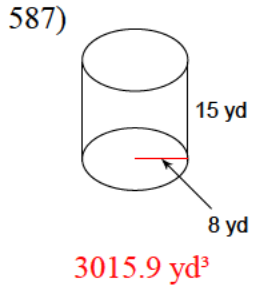
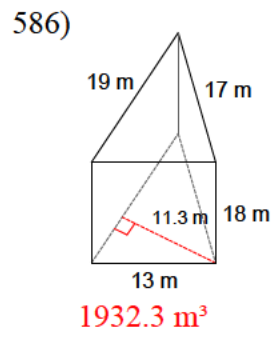
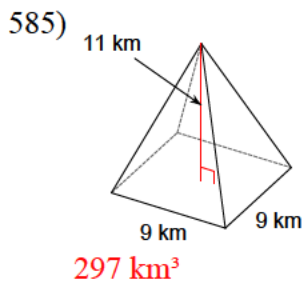

597)

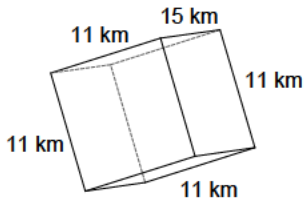

1815 km³

598)

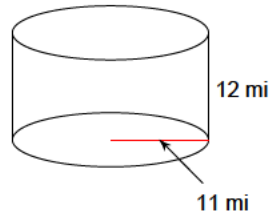

4561.6 mi³

599)

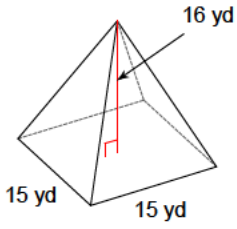

1200 yd³

600)

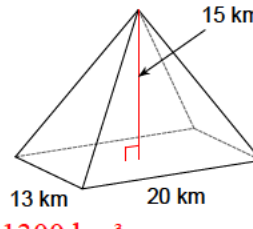

1300 km³

Find the volume of each prism, pyramid, cylinder or cone:

601)

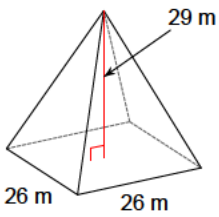

6534.7 m³

602)

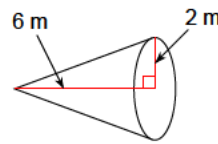

25.1 m³

603)

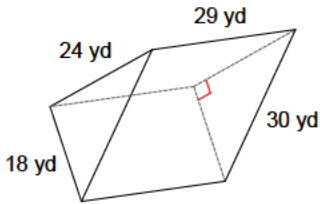

6264 yd³

604)

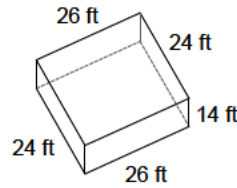

8736 ft³

605)

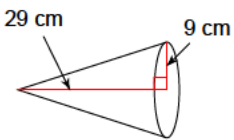

2459.9 cm³

606)

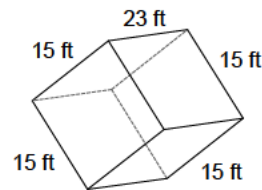

5175 ft³

607)

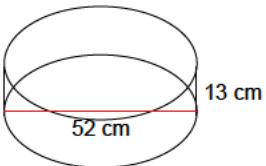

27608.3 cm³

608)

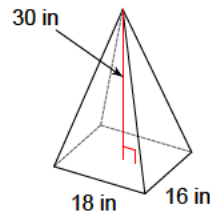

2880 in³

609)

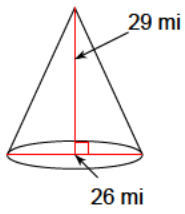

5132.3 mi^3

610)

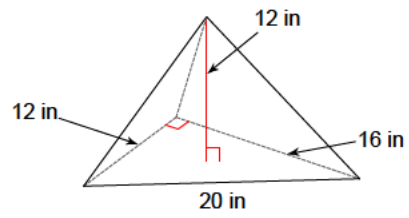

384 in^3

611)

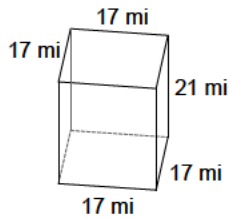

6069 mi^3

612)

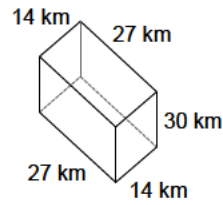

11340 km^3

613)

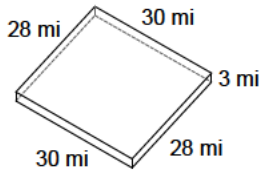

2520 mi^3

614)

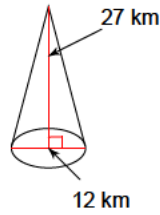

1017.9 km^3

615)

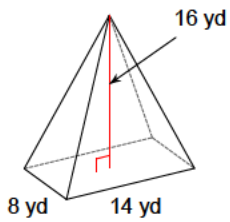

597.3 yd^3

616)

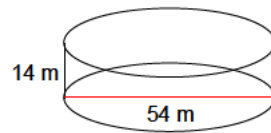

32063.1 m^3

617)

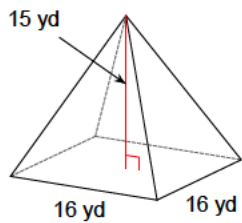

1280 yd^3

618)

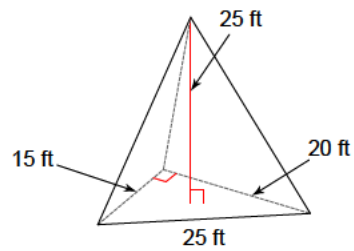

1250 ft^3

619)

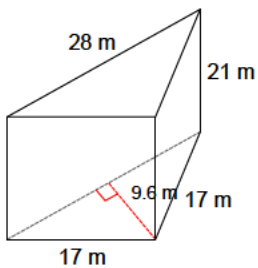

2822.4 m^3

620)

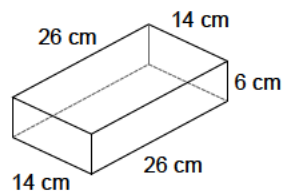

2184 cm^3

621)

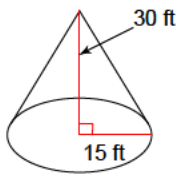
7068.6 ft³

622)

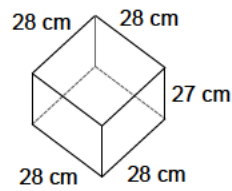
21168 cm³

623)

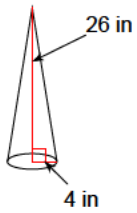
435.6 in³

624)

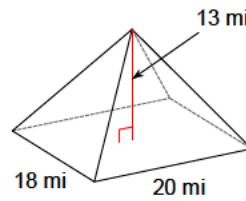
1560 mi³

625)

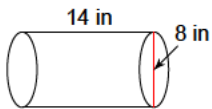
703.7 in³

626)

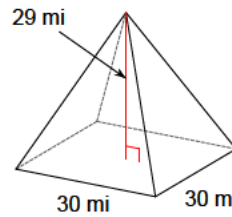
8700 mi³

627)

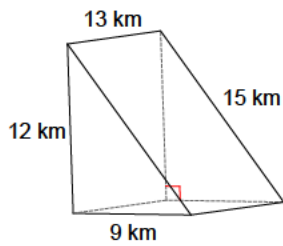
702 km³

628)

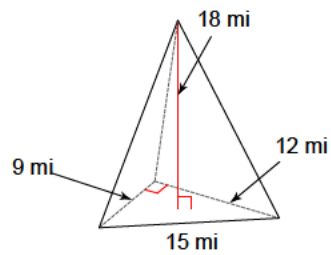
324 mi³

629)

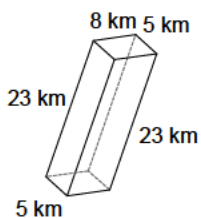
920 km³

630)

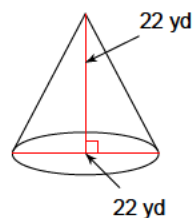
2787.6 yd³

631)

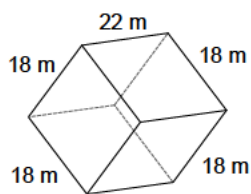
7128 m³

632)

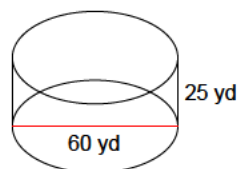
70685.8 yd³

633)

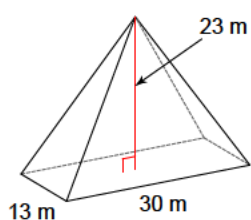
2990 m³

634)

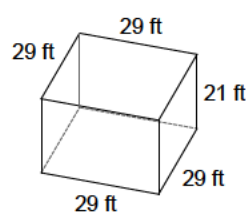
17661 ft³

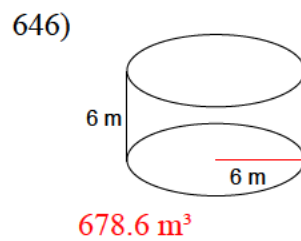
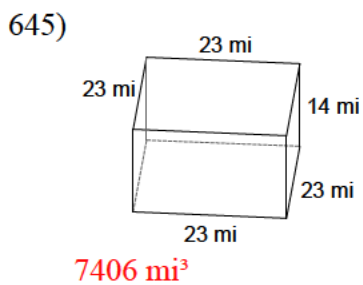
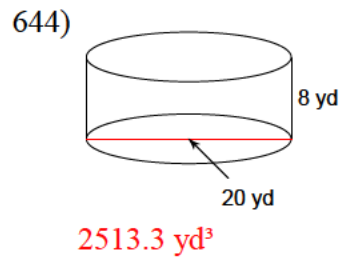
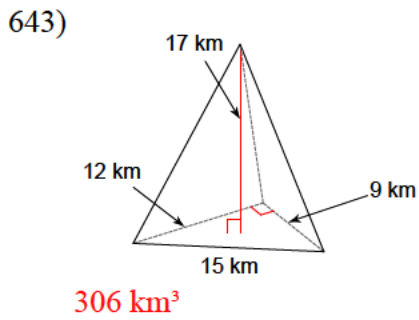
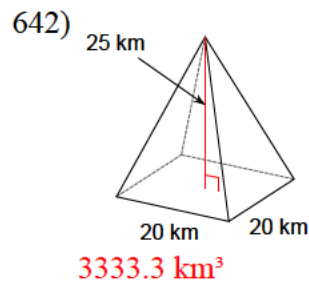
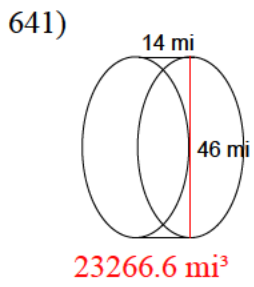
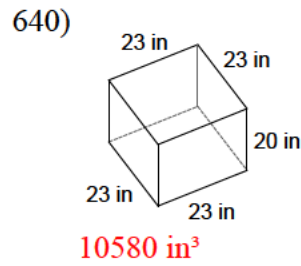
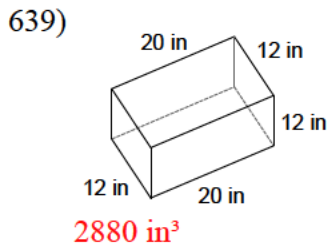
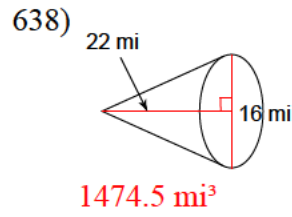
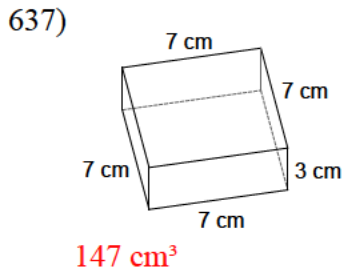
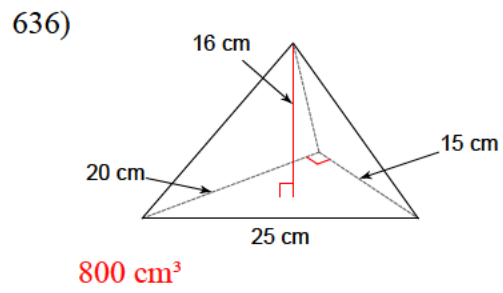
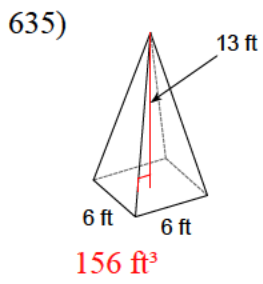

647)

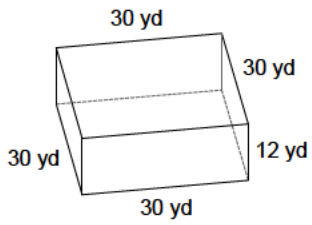

10800 yd^3

648)

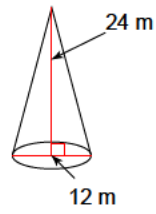

904.8 m^3

649)

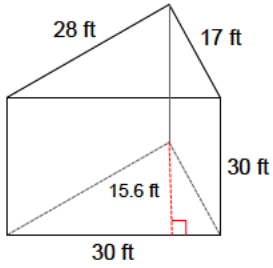

7020 ft^3

650)

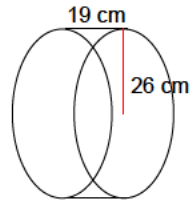

40350.6 cm^3

651)

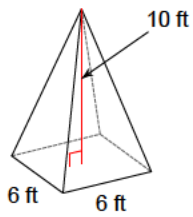

120 ft^3

652)

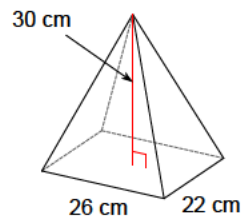

5720 cm^3

653)

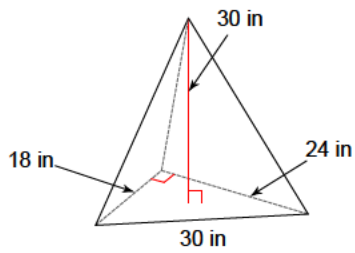

2160 in^3

654)

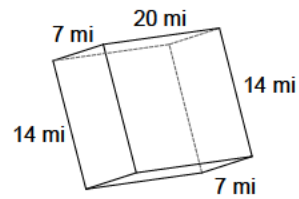

1960 mi^3

655)

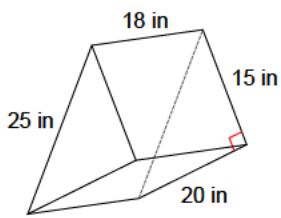

2700 in^3

656)

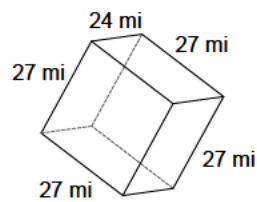

17496 mi^3

657)

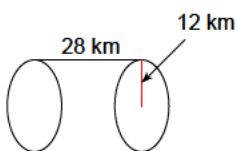

12666.9 km^3

658)

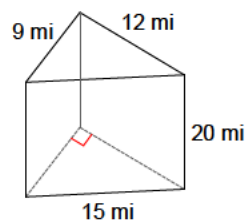

1080 mi^3

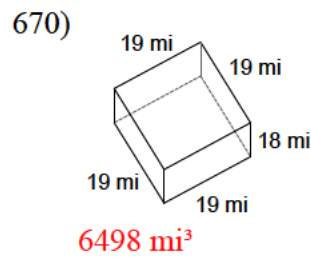
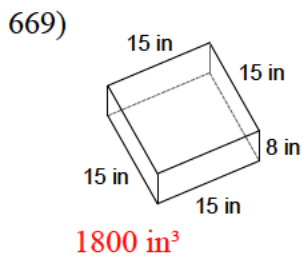
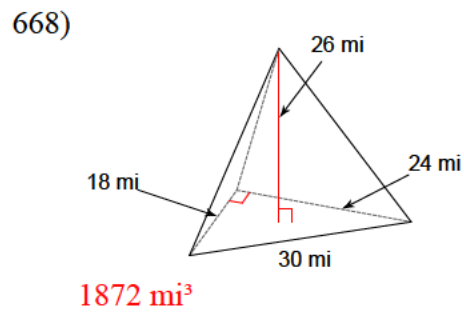
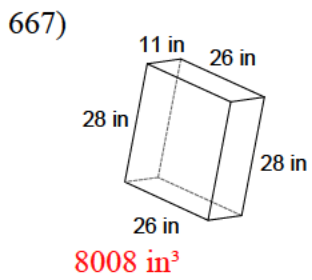
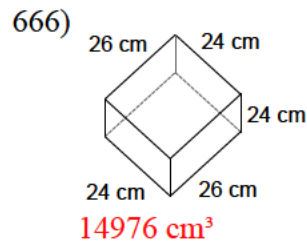
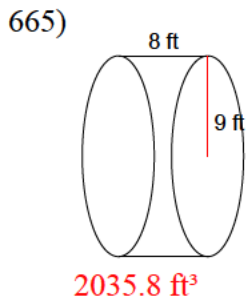
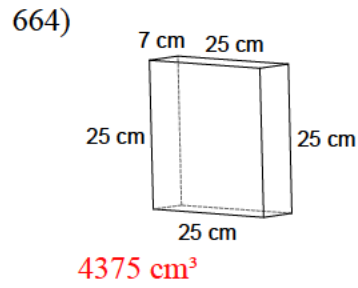
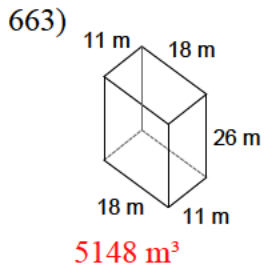
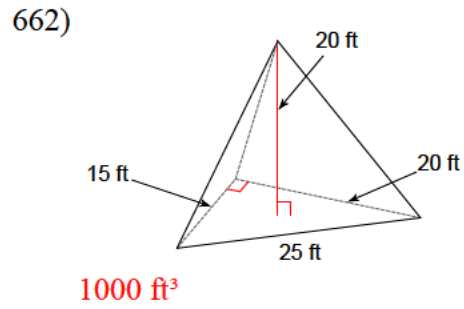
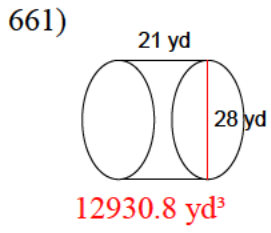
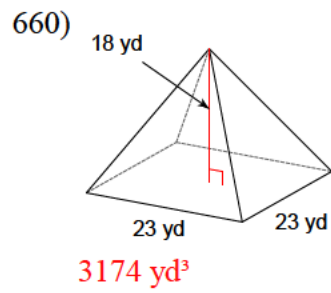
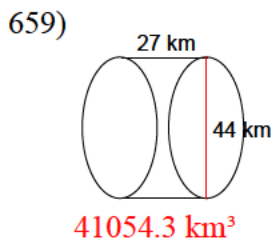

671)

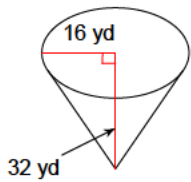

8578.6 yd³

672)

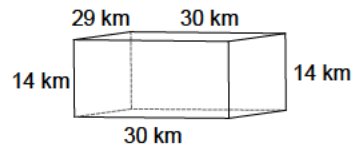

12180 km³

673)

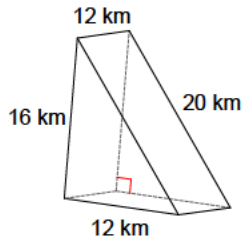

1152 km³

674)

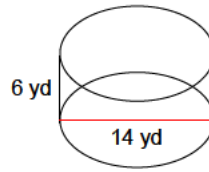

923.6 yd³

675)

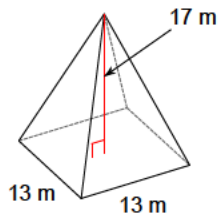

957.7 m³

676)

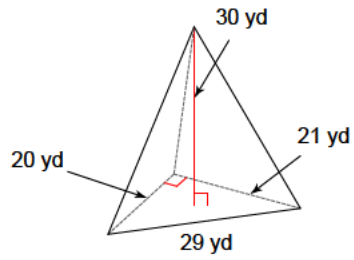

2100 yd³

677)

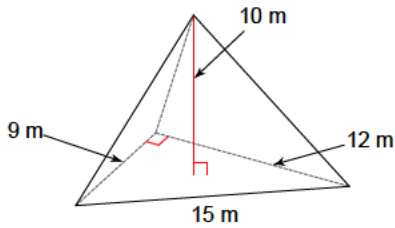

180 m³

678)

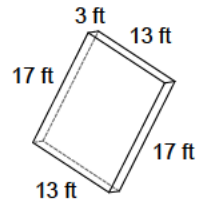

663 ft³

679)

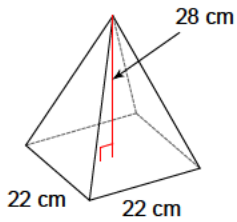

4517.3 cm³

680)

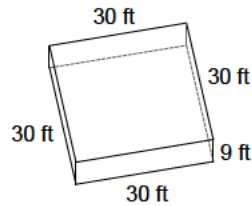

8100 ft³

681)

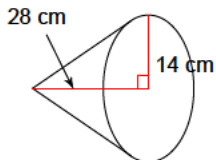

5747 cm³

682)

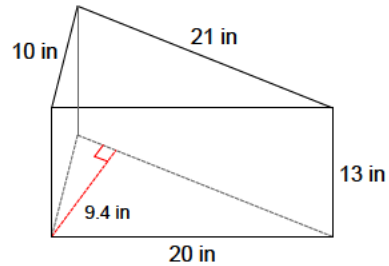

1283.1 in³

683)

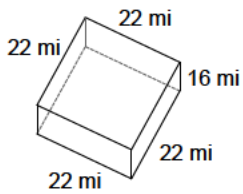

7744 mi^3

684)

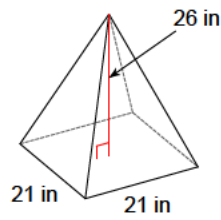

3822 in^3

685)

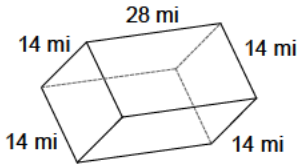

5488 mi^3

686)

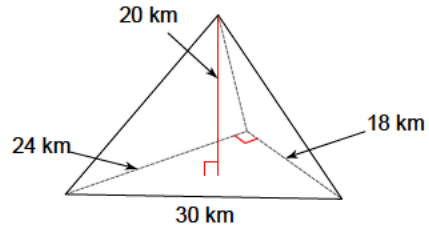

1440 km^3

687)

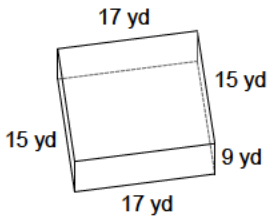

2295 yd^3

688)

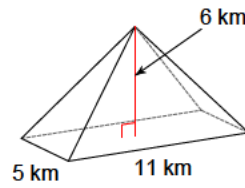

110 km^3

689)

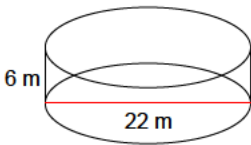

2280.8 m^3

690)

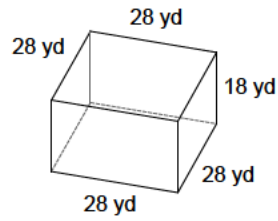

14112 yd^3

691)

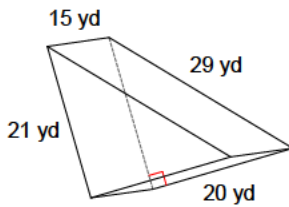

3150 yd^3

692)

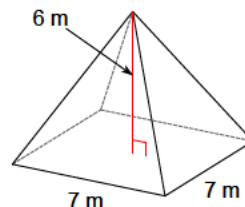

98 m^3

693)

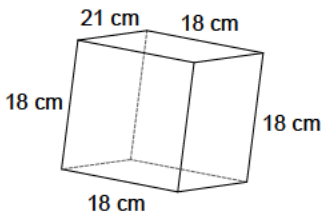

6804 cm^3

694)

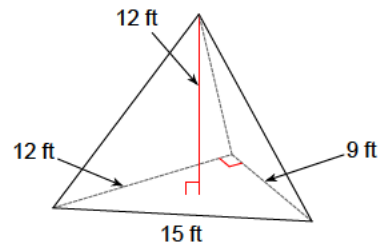

216 ft^3

695)

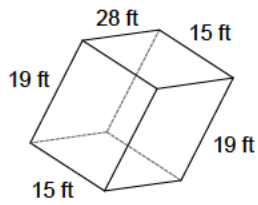

7980 ft^3

696)

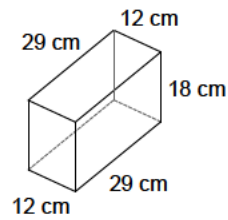

6264 cm^3

697)

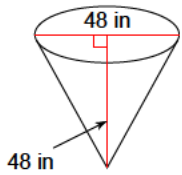

28952.9 in^3

698)

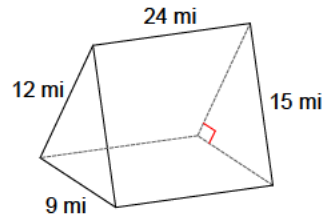

1296 mi^3

699)

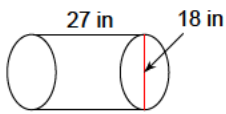

6870.7 in^3

700)

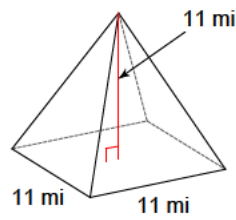

443.7 mi^3

Find the volume of each prism, pyramid, cylinder, cone or sphere:

701)

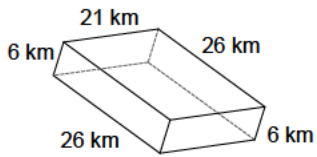

3276 km^3

702)

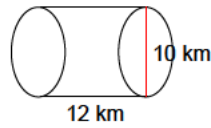

942.5 km^3

703)

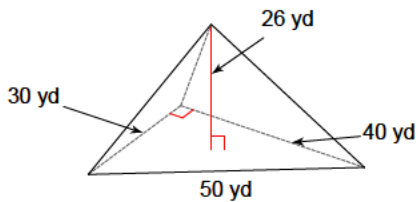

5200 yd^3

704)

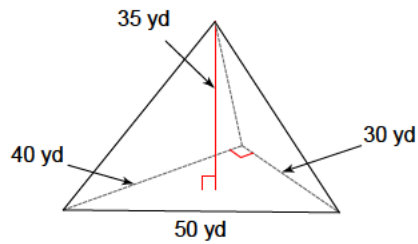

7000 yd^3

705)

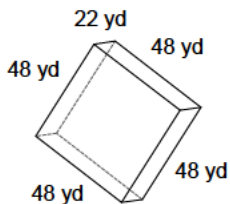

50688 yd^3

706)

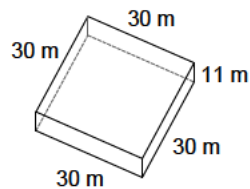

9900 m^3

707)

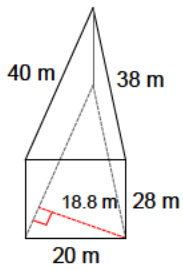

10528 m^3

708)

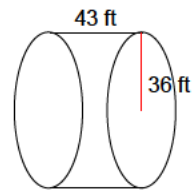

175075 ft^3

709)

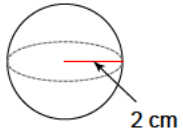

33.5 cm^3

710)

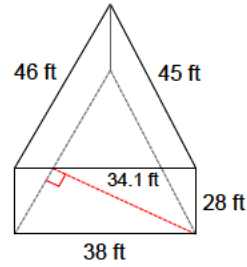

21960.4 ft^3

711)

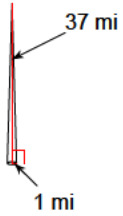

38.7 mi^3

712)

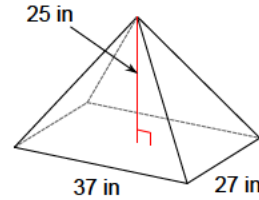

8325 in^3

713)

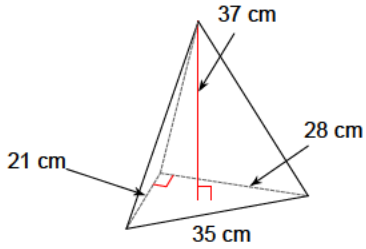

3626 cm^3

714)

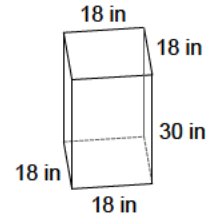

9720 in^3

715)

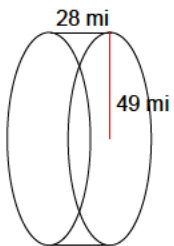

211203 mi^3

716)

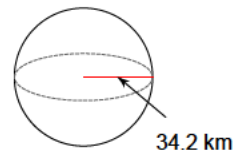

167559 km^3

717)

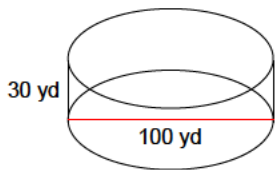

235619 yd^3

718)

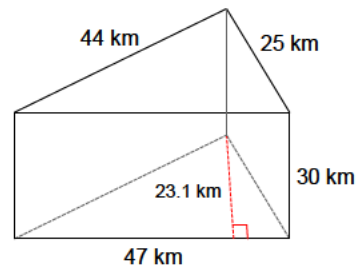

16285.5 km^3

719)

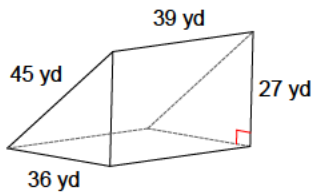

18954 yd³

720)

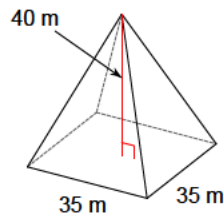

16333.3 m³

721)

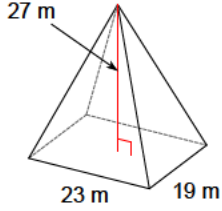

3933 m³

722)

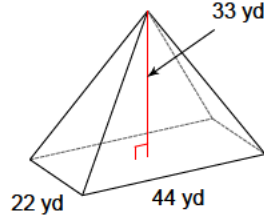

10648 yd³

723)

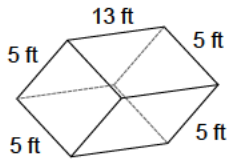

325 ft³

724)

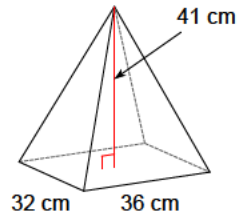

15744 cm³

725)

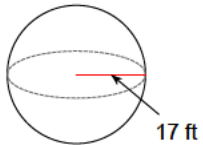

20579.5 ft³

726)

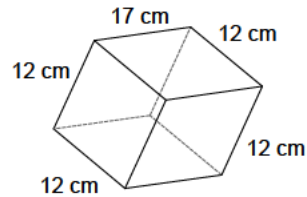

2448 cm³

727)

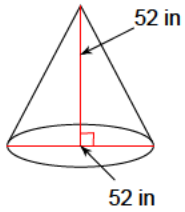

36811.1 in³

728)

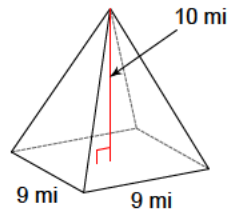

270 mi³

729)

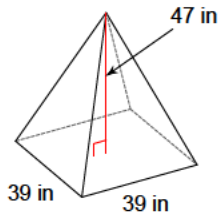

23829 in³

730)

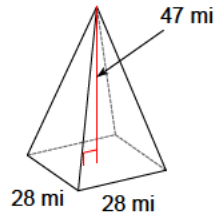

12282.7 mi³

731)

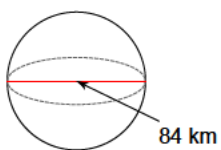

310339 km³

732)

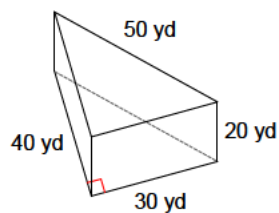

12000 yd³

733)

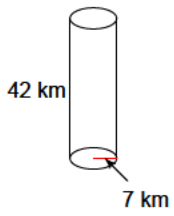

6465.4 km^3

734)

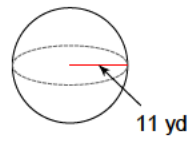

5575.3 yd^3

735)

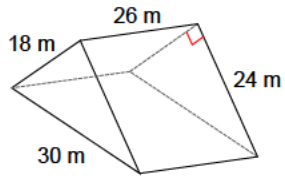

5616 m^3

736)

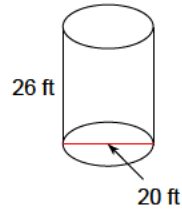

8168.1 ft^3

737)

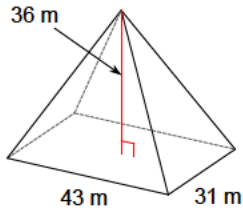

15996 m^3

738)

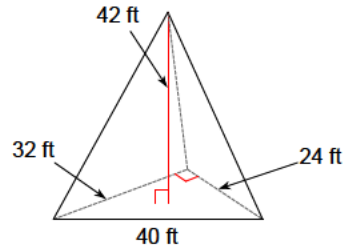

5376 ft^3

739)

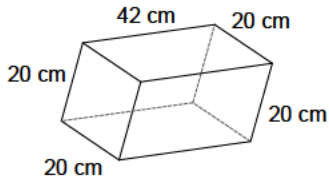

16800 cm^3

740)

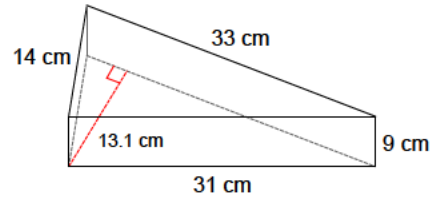

1945.4 cm^3

741)

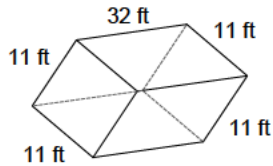

3872 ft^3

742)

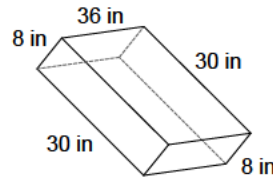

8640 in^3

743)

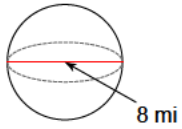

268.1 mi^3

744)

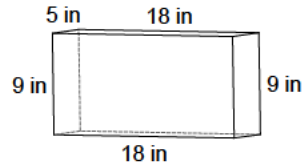

810 in^3

745)

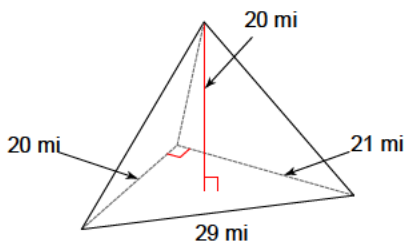

1400 mi^3

746)

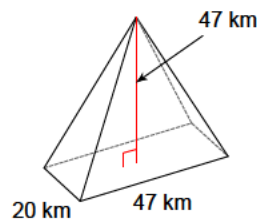

14726.7 km^3

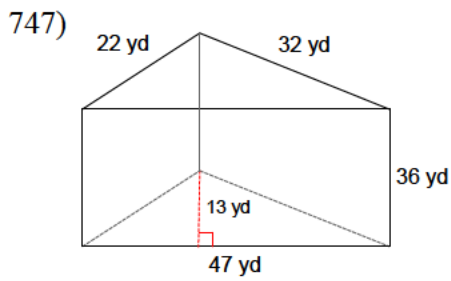

10998 yd^3

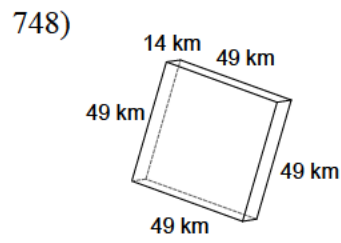

33614 km^3

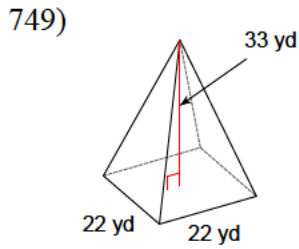

5324 yd^3

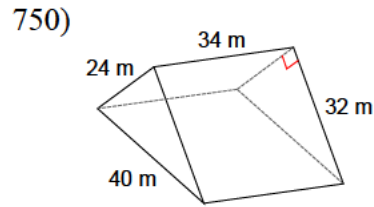

13056 m^3

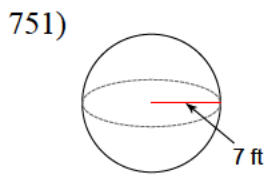

1436.8 ft^3

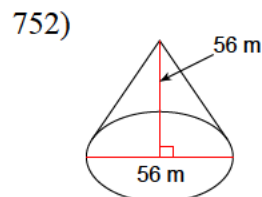

45976.2 m^3

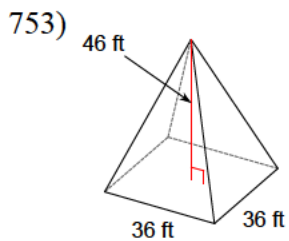

19872 ft^3

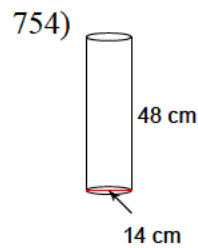

7389 cm^3

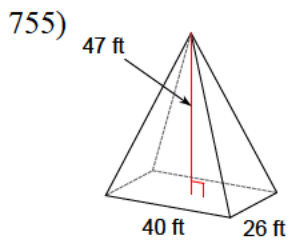

16293.3 ft^3

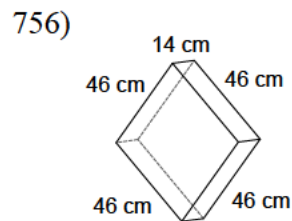

29624 cm^3

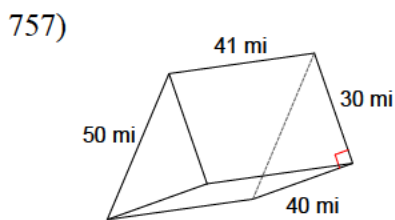

24600 mi^3

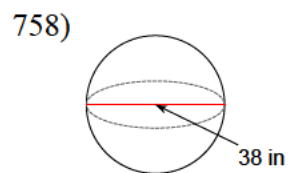

28730.9 in^3

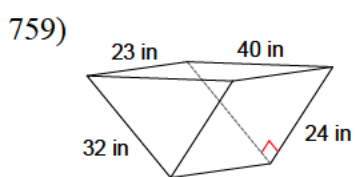

8836.4 in^3

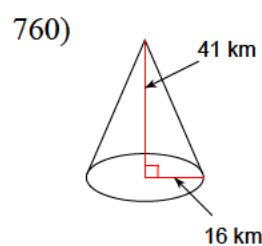

10991.4 km^3

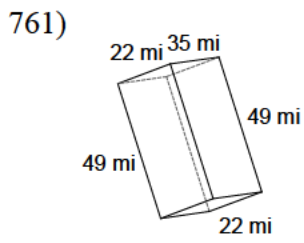

37730 mi^3

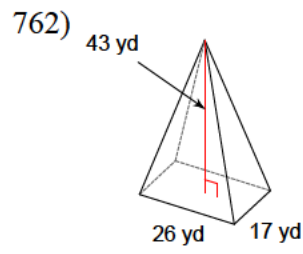

6335.3 yd^3

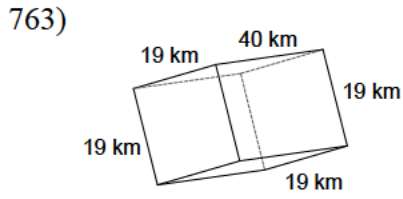

14440 km^3

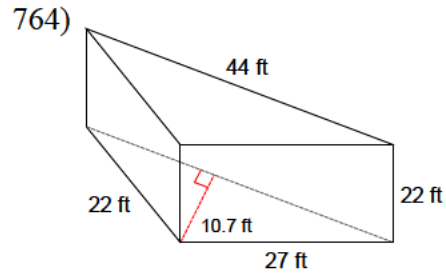

5178.8 ft^3

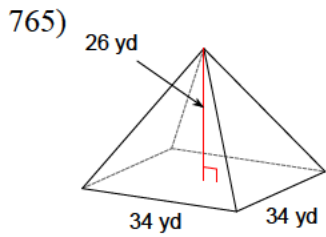

10018.7 yd^3

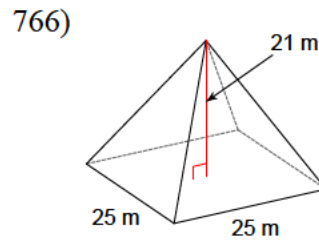

4375 m^3

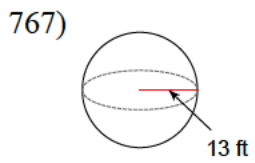

9202.8 ft^3

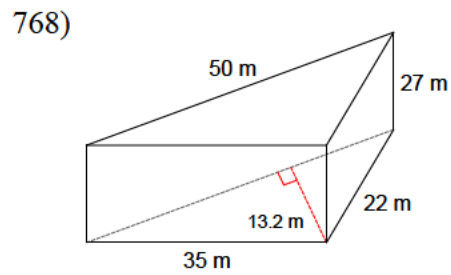

8910 m^3

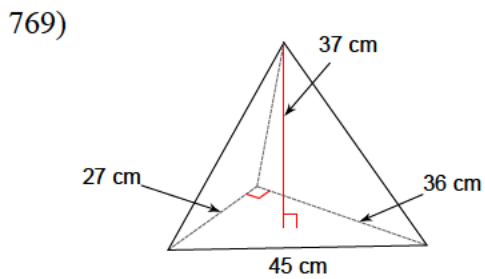

5994 cm^3

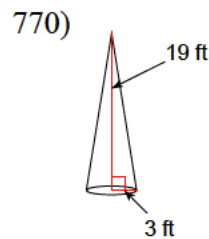

179.1 ft^3

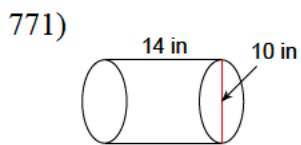

1099.6 in^3

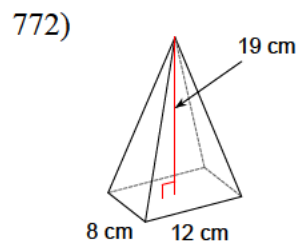

608 cm^3

773)

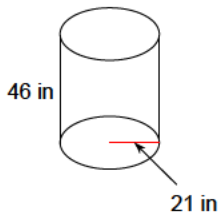

63730.3 in^3

774)

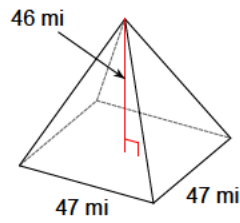

33871.3 mi^3

775)

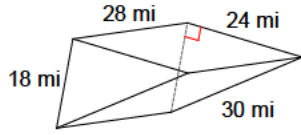

6048 mi^3

776)

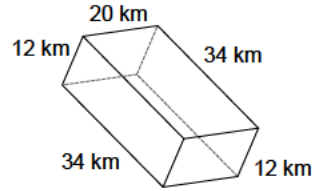

8160 km^3

777)

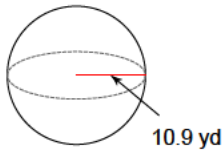

5424.6 yd^3

778)

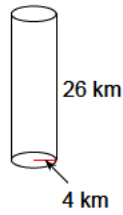

1306.9 km^3

779)

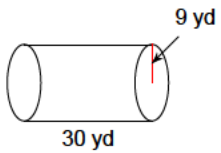

7634.1 yd^3

780)

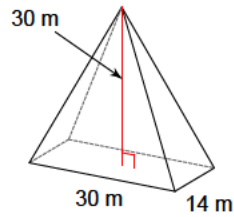

4200 m^3

781)

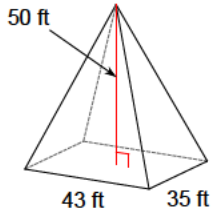

25083.3 ft^3

782)

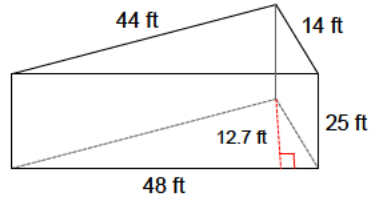

7620 ft^3

783)

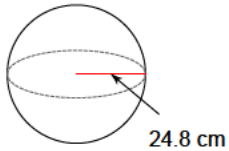

63891.6 cm^3

784)

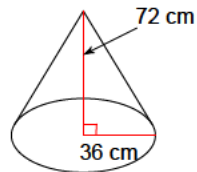

97716.1 cm^3

785)

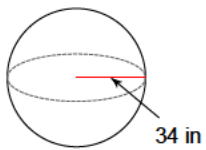

164636 in^3

786)

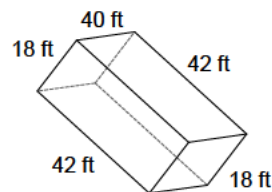

30240 ft^3

787)

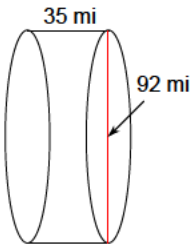

232666 mi^3

788)

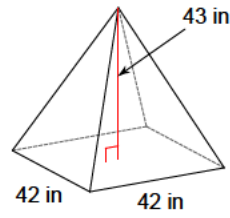

25284 in^3

789)

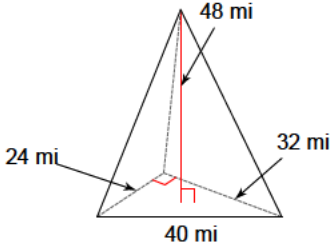

6144 mi^3

790)

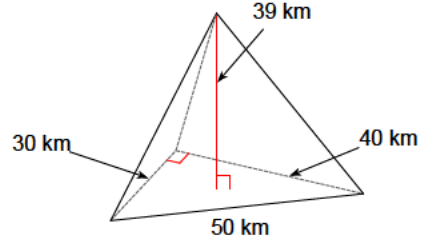

7800 km^3

791)

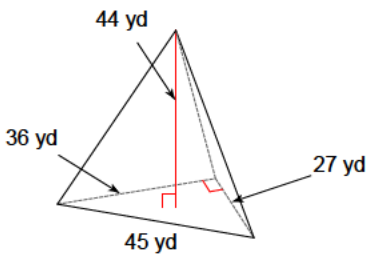

7128 yd^3

792)

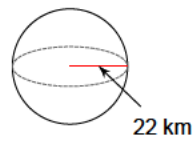

44602.2 km^3

793)

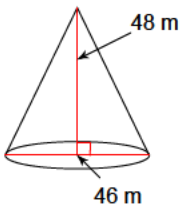

26590.4 m^3

794)

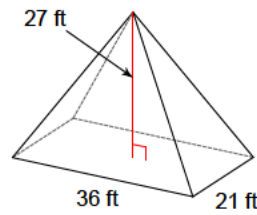

6804 ft^3

795)

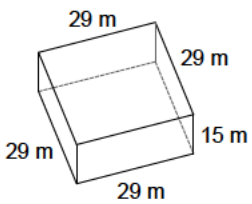

12615 m^3

796)

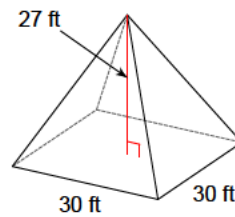

8100 ft^3

797)

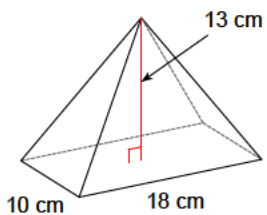

780 cm^3

798)

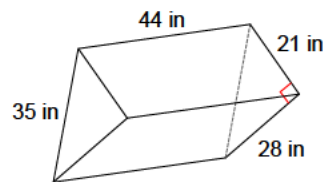

12933 in^3

799)

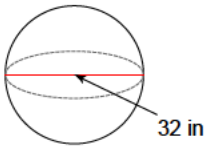

17157.3 in³

800)

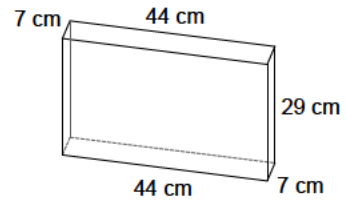

8932 cm³